

SYSMAC CS/CJ Series
WS02-LCTC1-EV5

CX-Process Tool Ver. 5.2

OPERATION MANUAL

OMRON

Wiki *کامپیوتر آنلاین*
LZonline

lalezaronline.com/wiki

WS02-LCTC1-EV5

CX-Process Tool Ver. 5.2

Operation Manual

Revised November 2007

Notice:

OMRON products are manufactured for use according to proper procedures by a qualified operator and only for the purposes described in this manual.

The following conventions are used to indicate and classify precautions in this manual. Always heed the information provided with them. Failure to heed precautions can result in injury to people or damage to property.

 **DANGER** Indicates an imminently hazardous situation which, if not avoided, will result in death or serious injury. Additionally, there may be severe property damage.

 **WARNING** Indicates a potentially hazardous situation which, if not avoided, could result in death or serious injury. Additionally, there may be severe property damage.

 **Caution** Indicates a potentially hazardous situation which, if not avoided, may result in minor or moderate injury, or property damage.

OMRON Product References

All OMRON products are capitalized in this manual. The word “Unit” is also capitalized when it refers to an OMRON product, regardless of whether or not it appears in the proper name of the product.

The abbreviation “Ch,” which appears in some displays and on some OMRON products, often means “word” and is abbreviated “Wd” in documentation in this sense.

The abbreviation “PLC” means Programmable Controller. “PC” is used, however, in some Programming Device displays to mean Programmable Controller.

Visual Aids

The following headings appear in the left column of the manual to help you locate different types of information.

Note Indicates information of particular interest for efficient and convenient operation of the product.

1, 2, 3... 1. Indicates lists of one sort or another, such as procedures, checklists, etc.

Copyrights and Trademarks

Windows is a registered trademark of the Microsoft Corporation.

Other system and product names that appear in this manual are the trademarks or registered trademarks of the respective company.

© OMRON, 2000

All rights reserved. No part of this publication may be reproduced, stored in a retrieval system, or transmitted, in any form, or by any means, mechanical, electronic, photocopying, recording, or otherwise, without the prior written permission of OMRON.

No patent liability is assumed with respect to the use of the information contained herein. Moreover, because OMRON is constantly striving to improve its high-quality products, the information contained in this manual is subject to change without notice. Every precaution has been taken in the preparation of this manual. Nevertheless, OMRON assumes no responsibility for errors or omissions. Neither is any liability assumed for damages resulting from the use of the information contained in this publication.

About Loop Controllers

Loop Control Types, Functional Elements, and Versions

Loop Controller Types

There are two types of CS/CJ-series Loop Controller: Separate Loop Controllers and Loop Controllers Pre-installed in CPU Units

| Loop Controller type | Type name | Product name | Model | PLC series and Unit type |
|---------------------------|---|--|-----------------|--|
| Separate | Separate Loop Controller | Loop Control Unit | CS1W-LC001 | CS-series CPU Bus Unit Loop Controller |
| | | Loop Control Board | CS1W-LCB01/05 | CS-series Inner Board Loop Controller |
| | | Loop Control Board with Gradient Temperature Controller | CS1W-LCB05-GTC | CS-series Inner Board Loop Controller |
| Pre-installed in CPU Unit | CPU Unit with Pre-installed Loop Controller | Process-control CPU Unit | CS1D-CPU□□P | A one-Unit Loop Controller consisting of an Inner Board pre-installed in a CS-series CS1D-H CPU Unit |
| | | Loop-control CPU Unit | CJ1G-CPU□□P | An Inner Board Loop Controller integrated into a CS-series CJ1-H CPU Unit |
| | | Loop-control CPU Unit with Gradient Temperature Controller | CJ1G-CPU□□P-GTC | An Inner Board Loop Controller integrated into a CJ-series CJ1-H CPU Unit |

Loop Controller Functional Elements

- Separate Loop Controllers consist of only the Loop Controller functional element (i.e., the Loop Controller element).
- CPU Units with Pre-installed Loop Controller consists of a CPU Unit functional element (i.e., the CPU Unit element) and the Loop Controller functional element (i.e., the Loop Controller element).

Versions

The functional elements (i.e., the CPU Unit element and Loop Controller element) have versions.

Model Numbers and Functional Elements

The following table lists the Loop Controller product model numbers, the functional element names for the CPU Unit elements and Loop Controller elements, and the versions of the functional elements.

| Product name | Product model number | Unit version of the product model (See note.) | Configuration | | | |
|--|----------------------|---|--|---------------------------------|-------------------------|--------------------|
| | | | CPU unit element | | Loop Controller element | |
| | | | CPU Unit model with same functionality | Functional element unit version | Functional element name | Functional element |
| Loop Control Unit | CS1W-LC001 | Pre-Ver. 2.0 | --- | | LC001 | Ver. 2.5 |
| Loop Control Board | CS1W-LCB01 | Ver. 2.0 or later | --- | | LCB01 | Ver. 2.0 or later |
| | CS1W-LCB05 | | --- | | LCB05 | Ver. 2.0 or later |
| Loop Control Board with Gradient Temperature Controller | CS1W-LCB05-GTC | Ver. 3.0 or later | --- | | LCB05-GTC | Ver. 3.0 or later |
| Process-control CPU Unit | CS1D-CPU65P | --- | CS1D-CPU65H | Ver. 1.0 or later | LCB05D | Ver. 1.0 |
| | CS1D-CPU67P | | CS1D-CPU67H | Ver. 1.0 or later | LCB05D | Ver. 1.0 |
| Loop-control CPU Unit | CJ1G-CPU42P | --- | CJ1G-CPU42H | Ver. 3.0 or later | LCB01 | Ver. 2.0 or later |
| | CJ1G-CPU43P | | CJ1G-CPU43H | Ver. 3.0 or later | LCB03 | Ver. 2.0 or later |
| | CJ1G-CPU44P | | CJ1G-CPU44H | Ver. 3.0 or later | LCB03 | Ver. 2.0 or later |
| | CJ1G-CPU45P | | CJ1G-CPU45H | Ver. 3.0 or later | LCB03 | Ver. 2.0 or later |
| Loop-control CPU Unit with Gradient Temperature Controller | CJ1G-CPU45P-GTC | Ver. 3.0 or later | CJ1G-CPU45H | Ver. 3.0 or later | LCB05-GTC | Ver. 3.0 or later |

Note Only Separate Loop Controllers have a unit version for the product model. CPU Units with Pre-installed Loop Controllers do not have a unit version for the product model.

Notation in this Manual

This manual uses the following notation.

- “Loop Controller” is used as a generic term to refer to the Loop Controllers in general.
- “LCB□□” is used to refer to specific Loop Controller functional elements. For example, the Loop Controller function element in a CS1W-LCB05 Loop Control Board is the LCB05, so “LCB05” is used to refer to the Loop Controller functional element. The Loop Controller function element in a CJ1G-CPU44P Loop-control CPU Unit is the LCB03, so “LCB03” is used to refer to the Loop Controller functional element.
- Model numbers are used to refer to specific Loop Controller models.

In the *CX-Process Tool Operation Manual* for version 3.2 or earlier, functional element names (LCB□□) are given as “Loop Control Board.” In the *CX-Process Tool Operation Manual* for version 4.0 or higher, simply “LCB□□” is used.

Unit Version Notation on Products

Loop Control Boards

A “unit version” has been introduced to manage CPU Units, Special I/O Units, and Inner Boards in the CS/CJ Series according to differences in functionality accompanying upgrades. This system applies to Units manufactured since October 1, 2003. The unit version code is provided on the nameplate of the product for which unit versions are being managed, as shown below for the Loop Control Board.

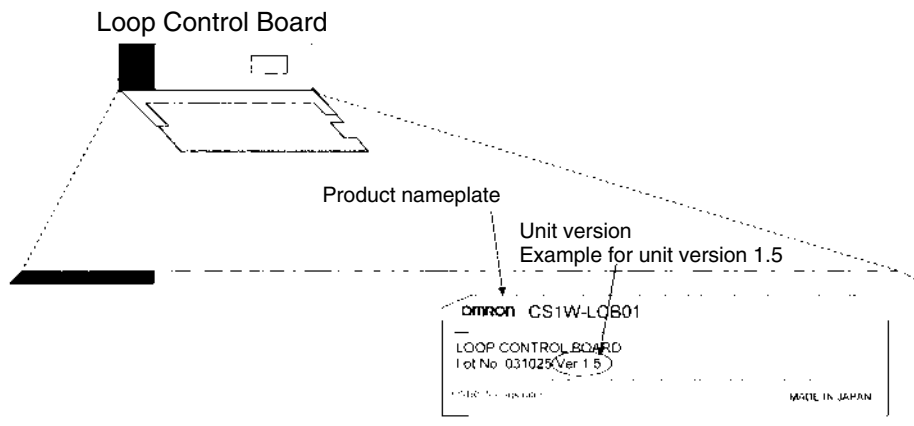

The CX-Process Tool can be used to confirm the unit versions of Loop Control Boards in the Monitor Run Status Window. After connecting the CX-Process Tool online, select **Operation – Monitor Run Status** from the Execute Menu. Confirm the unit version in ITEM099 (MPU/FROM version display) under from the System Common Block (Block Model 000) in the Monitor Run Status Window.

| ITEM | Data name | Data |
|------|-----------------------------|-------|
| 099 | MPU/FROM version indication | V1.50 |

Version V1.50 and onwards must be indicated.

Functional Element Name and Version Code for Process-control CPU Units and Loop-control CPU Units

The functional element name and functional element version code for Process-control CPU Units and Loop-control CPU Units are provided on the nameplate as shown in the following diagrams.

Process-control CPU Units

Note CPU Unit elements for which no version code is provided are pre-Ver. 2.0 CPU Units.

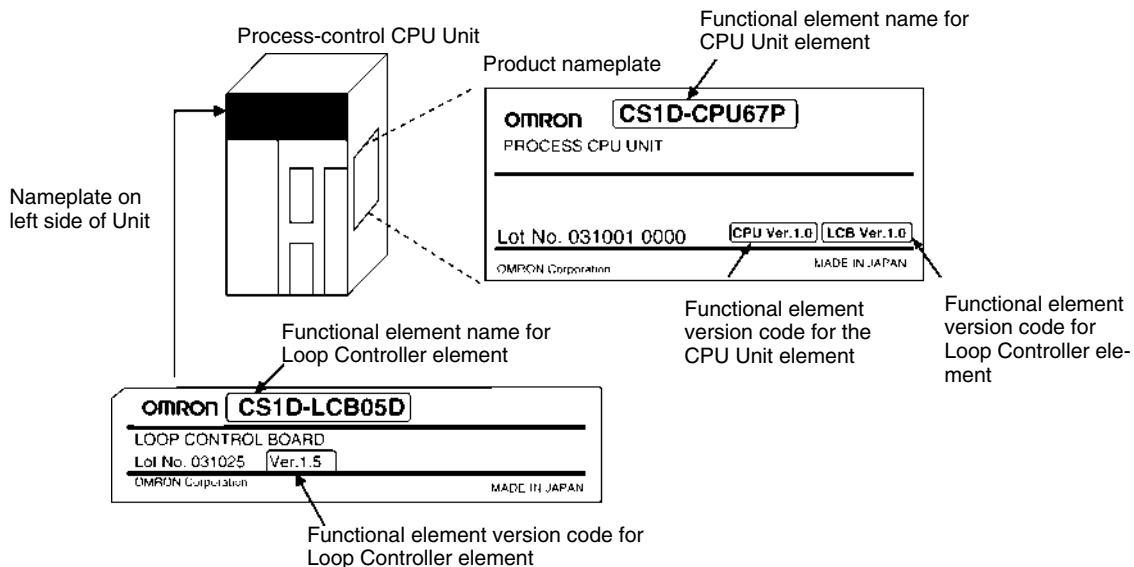

Loop-control CPU Units

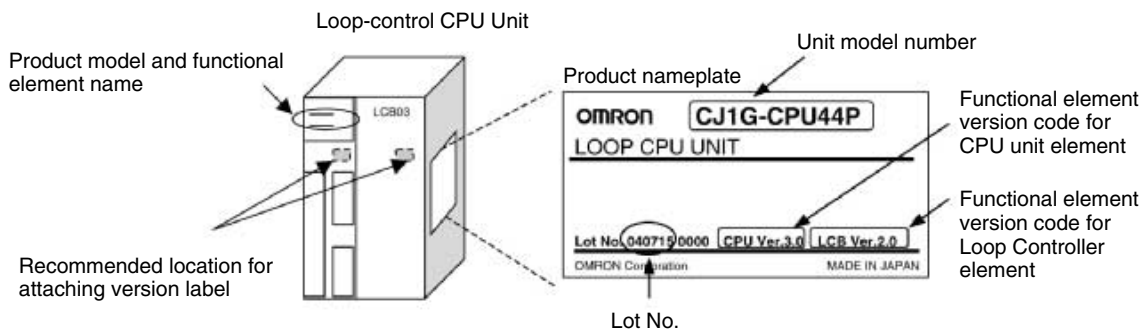

Confirming CPU Unit Element Versions with Support Software

CX-Programmer version 4.0 can be used to confirm the unit version using either of the following two methods.

- Using the *PLC Information*
- Using the *Unit Manufacturing Information* (This method can also be used for Special I/O Units and CPU Bus Units.)

Note CX-Programmer version 3.3 or lower cannot be used to confirm unit versions.

PLC Information

- 1, 2, 3... 1. If you know the device type and CPU type, select them in the **Change PLC** dialog box, go online, and select **PLC – Edit – Information** from the menus. If you do not know the device type and CPU type, but are connected directly to the CPU Unit on a serial line, select **PLC – Auto Online** to go online, and then select **PLC – Edit – Information** from the menus.
2. In either case, the following PLC Information Dialog Box will be displayed.

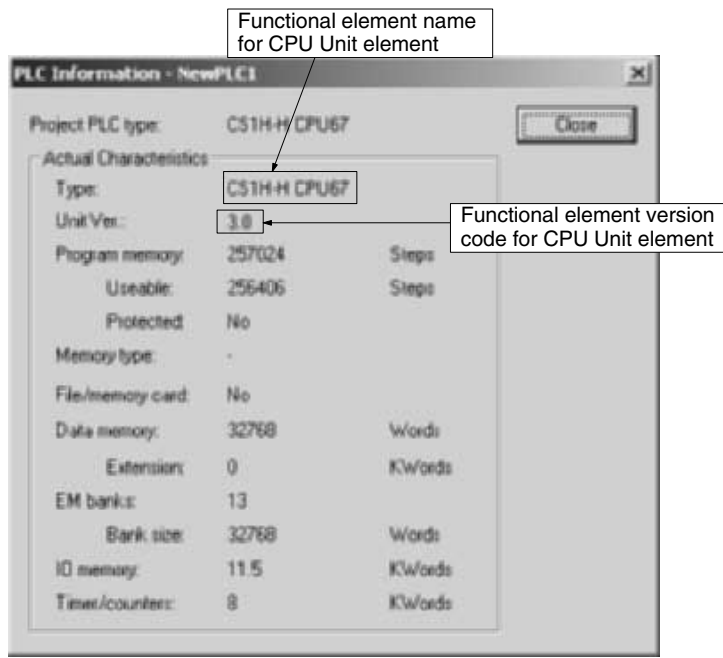

Use the above display to confirm the unit version of the CPU Unit that is connected online.

Unit Manufacturing Information

- 1, 2, 3... 1. In the I/O Table Window, right-click and select **Unit Manufacturing Information – CPU Unit**.

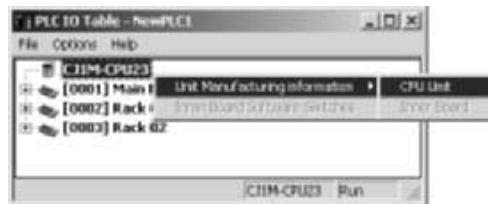

2. The following Unit Manufacturing Information Dialog Box will be displayed.

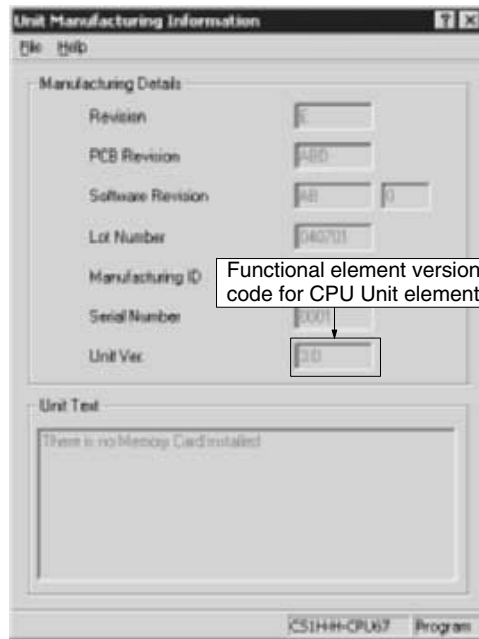

Use the above display to confirm the unit version of the CPU Unit connected online.

Functional Element Versions and Programming Devices

The Programming Device that supports the functional element version code must be used to enable all the functions in the corresponding functional element.

Note Upgrading versions is not necessary if only the basic functions of the CPU Unit element are required.

CPU Unit Element

| Loop Controller | | Programming Device | |
|-------------------------|----------------------------|--------------------|---------------------------|
| Functional element name | Functional element version | CX-Process Tool | CX-Programmer (See note.) |
| CS1G/H-CPU□□H | Pre-Ver. 2.0 | --- | --- |
| | Ver. 2.0 | | Ver. 4.0 or higher |
| | Ver. 3.0 | | Ver. 5.0 or higher |
| CS1D-CPU□□H | Ver. 1.1 | --- | Ver. 4.0 or higher |
| CJ1G-CPU□□H | Ver. 3.0 | | Ver. 5.0 or higher |
| | Ver. 4.0 | | Ver. 7.0 or higher |

Loop Controller Element

| Loop Controller | | Programming Device | |
|-------------------------|----------------------------|--------------------|---------------------------|
| Functional element name | Functional element version | CX-Process Tool | CX-Programmer (See note.) |
| LCB01 | Ver. 1.0 | Ver. 3.0 or higher | --- |
| | Ver. 1.5 | Ver. 3.2 or higher | |
| | Ver. 2.0 | Ver. 4.0 or higher | |
| | Ver. 3.0 | Ver. 5.0 or higher | |
| | Ver. 3.5 | Ver. 5.2 or higher | |
| LCB05 | Ver. 1.0 | Ver. 3.0 or higher | |
| | Ver. 1.5 | Ver. 3.2 or higher | |
| | Ver. 2.0 | Ver. 4.0 or higher | |
| | Ver. 3.0 | Ver. 5.0 or higher | |
| | Ver. 3.5 | Ver. 5.2 or higher | |
| LCB05-GTC | Ver. 3.0 | Ver. 5.1 or higher | |
| LCB03 | Ver. 2.0 | Ver. 4.0 or higher | |
| | Ver. 3.0 | Ver. 5.0 or higher | |
| | Ver. 3.5 | Ver. 5.2 or higher | |
| LCB03-GTC | Ver. 3.0 | Ver. 5.1 or higher | |
| LCB05D | Ver. 1.0 | Ver. 3.1 or higher | |

TABLE OF CONTENTS

| | |
|--|--------------|
| PRECAUTIONS | xxiii |
| 1 Intended Audience | xxiv |
| 2 General Precautions | xxiv |
| 3 Safety Precautions | xxiv |
| 4 Application Precautions | xxvi |
| SECTION 1 | |
| Introduction | 1 |
| 1-1 CX-Process Tool | 2 |
| 1-2 Relationship with CX-Process Monitor | 9 |
| 1-3 CX-Process Tool Specifications | 13 |
| 1-4 Version Improvements | 15 |
| 1-5 Function Blocks/ITEMs Incompatible with Earlier Versions | 25 |
| 1-6 Connecting to the PLC | 31 |
| 1-7 Basic Operating Procedures | 36 |
| 1-8 Operations | 44 |
| SECTION 2 | |
| Preparations to Create Function Blocks | 49 |
| 2-1 Installing and Uninstalling the Software | 50 |
| 2-2 Overview of User Interface | 69 |
| SECTION 3 | |
| Creating Function Blocks | 97 |
| 3-1 Creating Function Block | 99 |
| 3-2 Using the CX-Process Monitor | 132 |
| 3-3 Using the CX-Process Monitor Plus | 138 |
| 3-4 Using SCADA Software | 141 |
| 3-5 User Link Tables | 159 |
| 3-6 Creating User-defined Blocks | 173 |
| 3-7 Creating Step Ladder Program Instructions | 180 |
| 3-8 Creating Sequence Tables | 195 |
| 3-9 Displaying and Setting in Engineering Units | 207 |
| 3-10 Displaying Loop Controller Memory Maps | 212 |
| 3-11 Printing | 216 |
| 3-12 Setting Options | 224 |
| SECTION 4 | |
| Online Operation | 235 |
| 4-1 Overview of Online Functions | 236 |
| 4-2 Initial Settings for Online Connections | 238 |
| 4-3 Downloading, Uploading and Comparing Data | 251 |
| 4-4 Run/Stop Command | 264 |
| 4-5 Monitor Run Status | 266 |
| 4-6 Operation Check | 270 |
| 4-7 Tuning | 294 |
| 4-8 Backup and Recovery | 306 |
| 4-9 Transferring Tag and Comment Data | 309 |
| 4-10 Clear All | 313 |
| 4-11 Controlling the CPU Unit | 314 |
| 4-12 Password Protection | 315 |
| SECTION 5 | |
| Troubleshooting | 317 |
| 5-1 Troubleshooting | 318 |
| 5-2 Error Codes | 319 |

TABLE OF CONTENTS

Appendices

| | |
|---|------------|
| A Table of LC Type Changes | 323 |
| B ITEM Notation in Block Diagrams | 325 |
| C Setting Segment Programs | 329 |
| D Sequence Table Design Sheet | 337 |
| Revision History | 339 |

About this Manual:

This manual describes the installation and operation of the WS02-LCTC1-EV5 CX-Process Tool software package and includes the sections described below. The CX-Process Tool is used to create and test function blocks for the CS1W-LC001 Loop Control Unit, the CS1W-LCB01, CS1W-LCB05, and CS1W-LCB05-GTC Loop Control Boards, the CS1D-CPU□□P Process-control CPU Units, and the CJ1G-CPU□□P and CJ1G-CPU□□P-GTC Loop-control CPU Units.

In this manual, the WS02-LCTC1-EV5 CX-Process Tool software package is generally referred to as simply the “CX-Process Tool.”

Please read this manual carefully and be sure you understand the information provided before attempting to install and operate the CX-Process Tool. Please read the following manuals carefully and be sure you understand the information provided before setting up or using an application for a Loop Control Unit/Board.

| Product | Manual name | Cat. No. | Contents |
|--|---|-----------------------|---|
| WS02-LCTC1-EV5 CX-Process Tool | CX-Process Tool Operation Manual | W372 (this manual) | Installation and operation procedures for the CX-Process Tool. |
| CXONE-AL□□C-EV 2/AL□□D-EV2 CX-One Ver. 2.0 FA Integrated Tool Package | CXONE-AL□□C-EV 2/AL□□D-EV2 CX-One Ver. 2.0 FA Integrated Tool Package Setup Manual | W463 | Provides an overview of the CX-One and describes the installation procedures for CX-One software. Refer to this manual when installing the CX-Integrator from the CX-One. |
| WS02-LCTC1-E CX-Process Monitor | CX-Process Monitor Operation Manual | W373 | Installation and operation procedures for the CX-Process Monitor. |
| WS02-LCMC1-E CX-Process Monitor Plus | CX-Process Monitor Plus Operation Manual | W428 | Installation and operation procedures for the CX-Process Monitor Plus. |
| CS1W-LC001 Loop Control Unit | Loop Control Unit Operation Manual | W374 | Installation and operation procedures for the Loop Control Unit (except for function blocks). |
| CS1W-LCB01/05 Loop Control Boards, CS1D-CPU□□P Process-control CPU Units, and CJ1G-CPU□□P Loop-control CPU Units | Loop Control Board Operation Manual | W406 | Installation and operation procedures for the Loop Control Boards (except for function blocks). |
| CS1W-LC001 Loop Control Unit | Loop Control Unit Function Block Reference Manual | W375 | Detailed information on function blocks for Loop Control Units. |
| CS1W-LCB01/05 Loop Control Boards, CS1D-CPU□□P Process-control CPU Units, and CJ1G-CPU□□P Loop-control CPU Units | Loop Control Board Function Block Reference Manual | W407 | Detailed information on function blocks for Loop Control Boards |
| CS1W-LCB05-GTC Loop Control Board with Gradient Temperature Controller CJ1G-CPU45P-GTC Loop-control CPU Unit with Gradient Temperature Controller | Loop Control Board with Gradient Temperature Controller User's Manual | W460 | Provides information required when using the gradient temperature control functions. For information not related to the gradient temperature control functions, please refer to the Loop Control Board Operation Manual (Cat. No. W406). |

For details on procedures for installing the CX-Process Tool from the CX-One FA Integrated Tool Package, refer to the *CX-One Ver. 2.0 Setup Manual* provided with CX-One.

| Cat. No. | Model | Manual name | Contents |
|----------|-------------------------------|--------------------------------|---|
| W463 | CXONE-AL□□C-EV 2/AL□□D-EV2 | CX-One Ver.2.0 Setup Manual | Installation and overview of CX-One FA Integrated Tool Package. |

Section 1 introduces the operations of the CX-Process Tool and connections to the PLC.

Section 2 describes installing the CX-Process Tool and provides an overview of the user interface.

Section 3 describes how to create and manipulate function blocks.

Section 4 describes online operations for uploading, downloading, and testing function block data.

Section 5 describes errors that can occur while using the CX-Process Tool.



WARNING Failure to read and understand the information provided in this manual may result in personal injury or death, damage to the product, or product failure. Please read each section in its entirety and be sure you understand the information provided in the section and related sections before attempting any of the procedures or operations given.

Read and Understand this Manual

Please read and understand this manual before using the product. Please consult your OMRON representative if you have any questions or comments.

Warranty and Limitations of Liability

WARRANTY

OMRON's exclusive warranty is that the products are free from defects in materials and workmanship for a period of one year (or other period if specified) from date of sale by OMRON.

OMRON MAKES NO WARRANTY OR REPRESENTATION, EXPRESS OR IMPLIED, REGARDING NON-INFRINGEMENT, MERCHANTABILITY, OR FITNESS FOR PARTICULAR PURPOSE OF THE PRODUCTS. ANY BUYER OR USER ACKNOWLEDGES THAT THE BUYER OR USER ALONE HAS DETERMINED THAT THE PRODUCTS WILL SUITABLY MEET THE REQUIREMENTS OF THEIR INTENDED USE. OMRON DISCLAIMS ALL OTHER WARRANTIES, EXPRESS OR IMPLIED.

LIMITATIONS OF LIABILITY

OMRON SHALL NOT BE RESPONSIBLE FOR SPECIAL, INDIRECT, OR CONSEQUENTIAL DAMAGES, LOSS OF PROFITS OR COMMERCIAL LOSS IN ANY WAY CONNECTED WITH THE PRODUCTS, WHETHER SUCH CLAIM IS BASED ON CONTRACT, WARRANTY, NEGLIGENCE, OR STRICT LIABILITY.

In no event shall the responsibility of OMRON for any act exceed the individual price of the product on which liability is asserted.

IN NO EVENT SHALL OMRON BE RESPONSIBLE FOR WARRANTY, REPAIR, OR OTHER CLAIMS REGARDING THE PRODUCTS UNLESS OMRON'S ANALYSIS CONFIRMS THAT THE PRODUCTS WERE PROPERLY HANDLED, STORED, INSTALLED, AND MAINTAINED AND NOT SUBJECT TO CONTAMINATION, ABUSE, MISUSE, OR INAPPROPRIATE MODIFICATION OR REPAIR.

Application Considerations

SUITABILITY FOR USE

OMRON shall not be responsible for conformity with any standards, codes, or regulations that apply to the combination of products in the customer's application or use of the products.

At the customer's request, OMRON will provide applicable third party certification documents identifying ratings and limitations of use that apply to the products. This information by itself is not sufficient for a complete determination of the suitability of the products in combination with the end product, machine, system, or other application or use.

The following are some examples of applications for which particular attention must be given. This is not intended to be an exhaustive list of all possible uses of the products, nor is it intended to imply that the uses listed may be suitable for the products:

- Outdoor use, uses involving potential chemical contamination or electrical interference, or conditions or uses not described in this manual.
- Nuclear energy control systems, combustion systems, railroad systems, aviation systems, medical equipment, amusement machines, vehicles, safety equipment, and installations subject to separate industry or government regulations.
- Systems, machines, and equipment that could present a risk to life or property.

Please know and observe all prohibitions of use applicable to the products.

NEVER USE THE PRODUCTS FOR AN APPLICATION INVOLVING SERIOUS RISK TO LIFE OR PROPERTY WITHOUT ENSURING THAT THE SYSTEM AS A WHOLE HAS BEEN DESIGNED TO ADDRESS THE RISKS, AND THAT THE OMRON PRODUCTS ARE PROPERLY RATED AND INSTALLED FOR THE INTENDED USE WITHIN THE OVERALL EQUIPMENT OR SYSTEM.

PROGRAMMABLE PRODUCTS

OMRON shall not be responsible for the user's programming of a programmable product, or any consequence thereof.

Disclaimers

CHANGE IN SPECIFICATIONS

Product specifications and accessories may be changed at any time based on improvements and other reasons.

It is our practice to change model numbers when published ratings or features are changed, or when significant construction changes are made. However, some specifications of the products may be changed without any notice. When in doubt, special model numbers may be assigned to fix or establish key specifications for your application on your request. Please consult with your OMRON representative at any time to confirm actual specifications of purchased products.

DIMENSIONS AND WEIGHTS

Dimensions and weights are nominal and are not to be used for manufacturing purposes, even when tolerances are shown.

PERFORMANCE DATA

Performance data given in this manual is provided as a guide for the user in determining suitability and does not constitute a warranty. It may represent the result of OMRON's test conditions, and the users must correlate it to actual application requirements. Actual performance is subject to the OMRON Warranty and Limitations of Liability.

ERRORS AND OMISSIONS

The information in this manual has been carefully checked and is believed to be accurate; however, no responsibility is assumed for clerical, typographical, or proofreading errors, or omissions.

PRECAUTIONS

This section provides general precautions for using the CX-Process Tool, CS/CJ-series Programmable Controllers (PLCs), and related devices.

The information contained in this section is important for the safe and reliable application of Programmable Controllers. You must read this section and understand the information contained before attempting to set up or operate a PLC system.

| | |
|---------------------------------|------|
| 1 Intended Audience | xxiv |
| 2 General Precautions | xxiv |
| 3 Safety Precautions | xxiv |
| 4 Application Precautions | xxvi |

1 Intended Audience

This manual is intended for the following personnel, who must also have knowledge of electrical systems (an electrical engineer or the equivalent) and instrumentation systems (a process engineer or the equivalent).

- Personnel in charge of installing FA systems.
- Personnel in charge of designing FA systems.
- Personnel in charge of managing FA systems and facilities.

2 General Precautions

The user must operate the product according to the performance specifications described in the operation manuals.

Before using the product under conditions which are not described in the manual or applying the product to nuclear control systems, railroad systems, aviation systems, vehicles, combustion systems, medical equipment, amusement machines, safety equipment, petrochemical plants, and other systems, machines, and equipment that may have a serious influence on lives and property if used improperly, consult your OMRON representative.

Make sure that the ratings and performance characteristics of the product are sufficient for the systems, machines, and equipment, and be sure to provide the systems, machines, and equipment with double safety mechanisms.

This manual provides information for programming and operating the Loop Controller. Be sure to read this manual before attempting to use the Loop Controller and keep this manual close at hand for reference during operation.

 **WARNING** It is extremely important that a PLC and all PLC Units/Boards be used for the specified purpose and under the specified conditions, especially in applications that can directly or indirectly affect human life. You must consult with your OMRON representative before applying a PLC System to the above-mentioned applications.

3 Safety Precautions

 **WARNING** Check the following items before starting to run the LCB□□:

- Do not allow the bank of the EM Area with the number specified for allocation to the HMI (human-machine interface) data to be used by the CPU Unit or other Units for any other purpose. The block allocated for the HMI is specified in ITEM 050 (EM Area Bank Allocated for HMI Memory = 0 to 12) of the System Common block. If areas overlap, the system may operate in an unexpected fashion, which may result in injury.
- Do not allow the area to which user link table data is written to be used by the CPU Unit or other Units for any other purpose. If areas overlap, the system may operate in an unexpected fashion, which may result in injury.
- Analog Input/Output Units used in combination with the LCB□□ must be mounted correctly, and the unit number set on the front panel of the Analog Input/Output Unit must match the unit number set on the Field Terminal block. If the unit numbers do not match, input/output (read/write) is performed on the data of another Special I/O Unit (i.e., the one whose unit number is set on the Field Terminal block).
- The defaults of the System Common block on the LCB□□ must be set correctly.

 **WARNING** Check the following items before starting Loop Controller operation:

Do not allow the area to which user link table data is written to overlap with any other area used by the CPU Unit or other Units. If areas overlap, the system may operate in an unexpected manner, which may result in injury.

When using a user link table to write bit data to I/O memory in the CPU Unit. Never allow ladder programming or communications processes in the CPU Unit to write to any bits in the words in which bits are written from a user link table. Depending on the timing, any attempts to write to these words from ladder programming or communications processes may be ignored. Example: If tag A in a user link table writes to bit 00 of W000 and an OUT instruction in the ladder program in the CPU Unit write to bit 01 of W000, the write from the ladder program may be ignored.

Analog I/O Units used in combination with the Loop Controller must be mounted correctly.

The unit number set on the front panel of the Analog I/O Unit must be the same as the unit number set on the Field Terminal Function Block. If the unit numbers are not the same, I/O (read/write) will be performed on the data for another Special I/O Unit (i.e., the one whose unit number is set in the Field Terminal Function Block).

The initial settings of the System Common Block in the Loop Controller must be set correctly. In particular, make sure that words in the Data Memory used for the Node Terminals in the CPU Unit controlling the Loop Controller are not used for other applications on the PLC.

When writing data to the I/O memory in the CPU Unit with function blocks (e.g., using Send All Blocks, Expanded DO/AO Terminal to CPU Unit, or DO/AO Terminal to CPU Unit), be sure that the words written to in I/O memory are not being used for any other purpose. If I/O memory words are allocated to more than one purpose, the PLC system may act unexpectedly and cause injury.

 **WARNING** Always stop the operation of the LCB□□ before converting any of the EM Area to file memory. If any part of the EM Area that is being used by the LCB□□ for the HMI is converted to file memory during Board operation, the system may operate in an unexpected fashion, which may result in injury.





 **WARNING** Do not perform processing in such a way that the Loop Controller and CPU Unit write to identical I/O memory words allocated to a contact output or analog output of an external Unit. If the same words are written to, the externally connected loads may act unexpectedly and cause injury.

 **WARNING** When the calibration function is executed, the MV (manipulated variable) will change due to changes in the PVs (present values) input to the control block. Therefore, set pseudo-input values to confirm safety when the MW changes before executing the calibration function. Devices may perform unexpected operations, resulting in serious accidents.

 **Caution** Before transferring function block data (initial setting data or operation data) to the Loop Controller, confirm that the destination for the data is correct and also confirm the overall safety of the system (including the Loop Controller). Not doing so may result in unexpected operation.



 **Caution** Before performing **Validate Action**, be sure to perform **Compare** on currently opened function files and the Loop Controller's function block data. If there are inconsistencies in the registered function blocks (block address vs. block model), it will not be possible to perform **Validate Action** correctly.









Before forcing changes of analog signals or contact signals using **Validate Action**, confirm the safety of the instrumentation system as a whole. Not doing so may result in unexpected operation.

-  **Caution** When downloading a sequence table for the LCB□□ (unit ver. 1.5 or later) that has been edited online with the CX-Process Tool version 3.2 or higher, confirm that the system will operate normally with the edited sequence. If the sequence is not suitable for operation, unexpected operation may result.
-  **Caution** Confirm in advance the conditions at any node for which the sequence table is being edited over a Controller Link or Ethernet network. Not doing so may result in unexpected operation.
-  **Caution** Confirm the status of connected devices before transferring the setting for the MV tight shut function and MV analog output reverse function to the Loop Controller. Devices and equipment may perform unexpected operations if the data destination is mistaken.
-  **Caution** When the calibration function is executed, the MV (manipulated variable) will change due to changes in the PVs (present values) input to the control block. Therefore, set pseudo-input values to confirm safety when the MV changes before executing the calibration function. Devices may perform unexpected operations, resulting in serious accidents.

4 Application Precautions

Observe the following precautions when using CX-Process Tool and Loop Controller.

-  **Caution** If the power supply is turned OFF while function block data is being backed up from RAM to flash memory, the backup will not be completed normally. If the power supply is turned back ON within 24 hours, however, the super capacitor will have held the RAM data. The backup operation will restart when power is turned ON and operation will start when the backup has been completed. If the power supply is turned OFF for more than 24 hours, however, RAM data will be lost and operation will be started with the data that was previously saved to flash memory. If this happens, the Cold Start Auto-execution Flag (A35807) will turn ON to show that the previous data has been used. Use this bit in programming to take whatever steps are necessary, such as downloading the most recent function block data. (For LCB□□ only)
-  **Caution** Loop Control Unit data is monitored and operated using CX-Process Monitor or CX-Process Monitor Plus based on the monitor tag files created using CX-Process Tool. When creating monitor tag files using CX-Process Tool, CX-Process Monitor must be installed on the same computer.
-  **Caution** Before using function block data in actual operation, confirm operation by monitoring run status (to check the load rate; select **Execute/Operation/Monitor Run Status**) and validating actions (select **Validate Action/Start**) with CX-Process Tool. In particular, be sure to confirm that the load rate will be less than 60%. (For details on the load rate, refer to the *Operation Manual* for the Loop Controller.)

-  **Caution** When uploading the Loop Controller's function block data, observe the following precautions.
- When performing **Upload New** for Loop Control Units of version 1.5 or earlier, data on the Edit Block Diagram Screen (function block information) will be lost, and the block diagram showing the connections between function blocks will not be displayed.
- When performing **Upload Previous**, if the data in the source file currently opened using the CX-Process Tool and the Loop Controller's function block data does not match the registered function blocks or the data on the Edit Block Diagram Screen, the data currently opened may change to illegal data.
-  **Caution** The Loop Controller can read and write I/O memory in the CPU Unit using the Field Terminal Function Blocks or CPU Terminal Blocks independent of the user program (Step Ladder Program) in the CPU Unit. Do not write to the same I/O memory words from both the Loop Controller and the CPU Unit.
-  **Caution** To hold an analog output or contact output at a specific value (for example, the maximum value or minimum value) when the Loop Controller stops running, create a Step Ladder Program in the CPU Unit so that the corresponding output bit allocated to Analog Output Unit or Contact Output Unit is set to the desired value using an NC condition of the Loop Controller Running Flag (bit 00 in allocated CIO word "n") as an input condition.
-  **Caution** If a fatal error occurs in the CPU Unit (including fatal errors created by execution of a FALS instruction), the Loop Controller will also stop running. To hold analog outputs to the previous values before the stop occurred, and to set analog outputs to either the minimum value or maximum value, use the output hold function of the Analog Output Unit or Analog I/O Unit.
-  **Caution** Before turning ON the power to the PLC, make sure that the facilities are safe. The analog output values and contact outputs from the Loop Controller are updated when the power to the PLC is turned ON regardless of the operating mode of the CPU Unit (including in the PROGRAM mode). (Internally, the analog output values and contact outputs are sent from the CPU Unit to Basic I/O Units and Analog Output Units.)
-  **Caution** Fail-safe measures must be taken by the customer to ensure safety in the event of incorrect, missing, or abnormal signals caused by broken signal lines, momentary power interruptions, or other causes.
-  **Caution** Confirm that no adverse effect will occur in the system before attempting any of the following:
- Changing the operating mode of the PLC (including the setting of the startup operating mode).
 - Force-setting/force-resetting any bit in memory
 - Changing the present value or any set value in memory
-  **Caution** Be sure that all mounting screws, terminal screws, and cable connector screws are tightened to the torque specified in the user manuals. Incorrect tightening torque may result in malfunction.

 **Caution** In the event of system or power failure, CX-Process function files (extension “.ist”) may not be saved. It is recommended that function files are saved regularly.

 **Caution** Do not connect pin 6 (+5 V power supply line) of the RS-232C port on the CPU Unit to any external device except the CJ1W-CIF11 RS-422A Adapter or NT-AL001 RS-232C/RS-422A Adapter. Doing so may damage the external device or CPU Unit.

SECTION 1

Introduction

This section introduces the operations of the CX-Process Tool and connections to the PLC.

| | | |
|--------|--|----|
| 1-1 | CX-Process Tool | 2 |
| 1-1-1 | Overview | 2 |
| 1-1-2 | Project Workspace | 3 |
| 1-1-3 | Files Created with CX-Process Tool | 3 |
| 1-1-4 | Relationships between Tag Files | 7 |
| 1-1-5 | Operating Conditions of CX-Process Tool | 8 |
| 1-2 | Relationship with CX-Process Monitor | 9 |
| 1-2-1 | Overview of the CX-Process Monitor and CX-Process Monitor Plus | 9 |
| 1-2-2 | Settings Required on the CX-Process Tool | 9 |
| 1-3 | CX-Process Tool Specifications | 13 |
| 1-4 | Version Improvements | 15 |
| 1-4-1 | Version 1.20 | 15 |
| 1-4-2 | Version 1.50 | 16 |
| 1-4-3 | Version 2.00 | 17 |
| 1-4-4 | Version 2.50 | 18 |
| 1-4-5 | Version 3.00 | 19 |
| 1-4-6 | Version 3.1 | 20 |
| 1-4-7 | Version 3.2 | 20 |
| 1-4-8 | Version 4.0 | 21 |
| 1-4-9 | Version 4.1 | 22 |
| 1-4-10 | Version 5.0 | 23 |
| 1-4-11 | Version 5.1 | 24 |
| 1-4-12 | Version 5.2 | 24 |
| 1-5 | Function Blocks/ITEMs Incompatible with Earlier Versions | 25 |
| 1-5-1 | Incompatibility with Versions Earlier than Version 1.20 | 25 |
| 1-5-2 | Incompatibility with Versions Earlier than Version 1.50 | 25 |
| 1-5-3 | Incompatibility with Versions Earlier than Version 2.00 | 26 |
| 1-5-4 | Incompatibility with Versions Earlier than Version 2.50 | 28 |
| 1-5-5 | Incompatibility with Versions Earlier than Version 3.2 | 29 |
| 1-5-6 | Incompatibility with Versions Earlier than Version 4.0 | 30 |
| 1-5-7 | Incompatibility with Versions Earlier than Version 5.0 | 30 |
| 1-5-8 | Incompatibility with Versions Earlier than Version 5.2 | 30 |
| 1-6 | Connecting to the PLC | 31 |
| 1-6-1 | Features of FinsGateway and CX-Server | 31 |
| 1-6-2 | Selecting the Communications Driver | 32 |
| 1-6-3 | Using FinsGateway | 32 |
| 1-6-4 | Connecting Cables | 35 |
| 1-7 | Basic Operating Procedures | 36 |
| 1-8 | Operations | 44 |
| 1-8-1 | Creating Function Blocks | 44 |
| 1-8-2 | Online Operations | 46 |

1-1 CX-Process Tool

1-1-1 Overview

The CX-Process Tool supports the following functions for Loop Controllers.

In this manual, the WS02-LCTC1-EV5 CX-Process Tool software package is generally referred to as simply the “CX-Process Tool.”

- Creating function blocks, including the following functions
 - Setting the Step Ladder Program Block (block 000), including the following: System common operation cycle, Loop Control Unit number (Loop Control Unit only), start mode, first address of data memory of node terminal (Loop Control Unit only)
 - Registering function blocks (allocating block addresses)
 - Connecting function blocks with analog and accumulator signals
 - Setting ITEMS in function blocks
 - Editing sequence tables (Block 302) and the Step Ladder Program Block (Block 302) (See note.)

Note Editing sequence tables is supported only by the CS1W-LCB05 Loop Control Board (00-LCB05) and CS1D-LCB05D Loop Control Board (00-LCB05D).

- Settings tags for CX-Process Monitor (Loop Control Unit only) or CX-Process Monitor Plus software or setting CSV tags for SCADA software (Tag Names and Analog Signals) and creating monitor tag files (Loop Control Unit only, CX-Process Monitor must be already installed), or CSV tag files.
- Downloading function block data to Loop Controllers
- Uploading data from Loop Controllers
- Comparing function block data with data in a Loop Controller or Function Block File
- Sending Run/Stop Commands to Loop Controller
- Monitoring status (including System Common Block Settings, Load Rate per Operation Cycle Group, and Execution Errors)
- Monitoring actions of Loop Controllers (including operation checks on function block diagrams and ladder diagrams)
- Tuning parameters such as PID constants in function blocks (Control Blocks)
- Backing up function block data from the Loop Controller’s RAM to flash memory and restoring that function block data from flash memory back to RAM
- Initializing function block data in Loop Controllers

Note To create monitor tag files using the CX-Process Tool with the CX-Process Monitor or CX-Process Monitor Plus software, both the CX-Process Tool, and CX-Process Monitor or CX-Process Monitor Plus, must be installed on the same computer.

1-1-2 Project Workspace

Project Workspace can be used to access the data created in memory with the CX-Process Tool. Data can be created for up to 32 CPU Units and 96 Loop Control Units (3 Loop Control Units each for 32 CPU Units) or 32 LCB□□s (1 LCB□□ each for 32 CPU Units). The data has the following configuration.

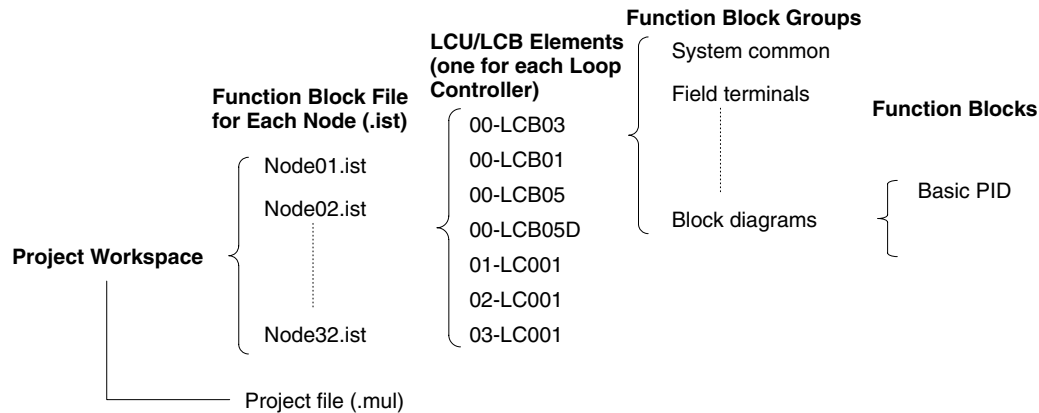

Project Workspace data is stored in one folder called the project folder. Project folders are created for the following commands.

- **File – New**
When a new project is created, the project name will be used as the folder name.
- **File – Save As**
When a project is saved under a new name, the new project name will be used as the folder name.

1-1-3 Files Created with CX-Process Tool

The CX-Process Tool creates a folder with the project name in the data folder under the default installation folder for the CX-Process Tool, and then creates the following files inside the project folder.

Project File (.mul)

The project file consists of administrative data for the Project Workspace.

| Files | File name extension | Remarks |
|--|-------------------------|--|
| Function block files | .ist | |
| Block diagram information files | .mtbd | |
| Mnemonics/Ladder diagram information files | .mtld | |
| Comment files | .cmt | |
| CSV tag setting files | <i>project_name.csv</i> | |
| CX-Server configuration files | .cdm | Only when CX-Server is selected as the communications driver |
| Job information files | .sjb | |
| Loop Controller configuration files | .lcb | |
| Data files of user link tables | LnkTable.csv | |
| Data files of sequence tables | .stbl | |

The project file (.mul) can be specified when opening files so that the above related files will be all read at the same time. The project file is created by selecting **New** from the File Menu and specifying the project name. The file name will be the same as the project name.

Function Block Files (.ist)

A function block file consists of the data for the function blocks of a single CPU Unit (i.e., for up to three LCU elements and/or one LCB□□ element). This file is created by selecting **Settings – Insert**. The file will be automatically named “Node XX,” where XX denotes the node number between 01 and 32.

The following data is contained in a function block file.

| Item | Data name | Description |
|---|----------------------|--|
| Function block data for one Loop Controller | Initial settings (S) | Data on registered function blocks (block address allocations), analog/accumulator signal software connections, and initial settings of each function block. |
| | Operation data (O) | Operation data for each function block |

The contents of the function block file (.ist) are used to compare download data and upload data. Initial settings (S), operation data (O), or initial settings and operation data together can be set in the function block file.

- Note**
1. The function block file does not include mnemonic data for Step Ladder Program Blocks. The mnemonic data is stored in the mnemonics/ladder diagram information file. Refer to *Mnemonics/Ladder Diagram Information File (.mtd) Created by System* below.
 2. Function block files (.ist) created for the CX-Process Tool can be imported to the Project Workspace data by selecting **Add Function Block File** from the File Menu.

Block Diagram Information Files (.mtbd)

The block diagram information file consists of graphic data that shows the software connections.

The system will automatically store this file with the function block file (.ist) in the same folder whenever a block diagram is edited. The user does not normally need to access the block diagram information file directly.

- Note**
1. When backing up or changing the storage location of this file, the file must be backed up or moved together with the node function block files because these files must always be in the same folder. The block diagram information files are named as shown below.

File name and extension: Name of function block file ○○ ○○ .mtbd

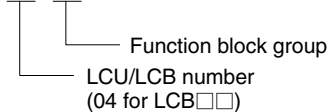

2. The block diagram information file (.mtbd) is not used for downloading, uploading, or comparing data, but the block diagram information between function blocks (i.e., ITEM data) is uploaded and downloaded if the Loop Control Unit is version 2.00 or later or an LCB□□ is used. Thus, newly uploaded data will have connection diagrams displayed between function blocks. (This is not actually the same as the connection diagram information file, and even though settings connections themselves will be restored, complex connections will be normalized for display.)

Mnemonics/Ladder Diagram Information Files (.mtd)

A mnemonics/ladder diagram information file consists of mnemonic data and ladder diagram data for sequence instructions in step ladder programs.

The system will automatically store this file with the function block file (.ist) in the same folder whenever a Step Ladder Program Block is registered. The user does not normally need to access the mnemonics/ladder diagram information file directly.

- Note**
1. When backing up or changing the storage location of this file, the file must be backed up or moved together with the node function block files because

these files must always be in the same folder. The mnemonics/ladder diagram information files are named as shown below.

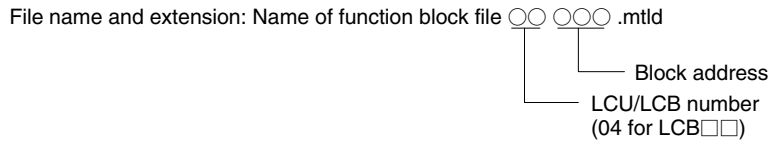

2. The mnemonic data in the mnemonics/ladder diagram information file (.mtd) is used in downloading, uploading, or comparing data but the ladder diagram data is not.

CX-Process Monitor Tag Files (with Fixed File Name without Extension)

A CX-Process Monitor tag file consists of monitor tag data (binary data) for a single CPU Unit (with a maximum of three Loop Control Units).

CX-Process Monitor tag data consists of tag names, tag comments, corresponding ITEM numbers or block addresses, and analog signal scaling data. By reading the tag file with the CX-Process Monitor, the block address or ITEM number in function block data corresponding to the CX-Process Monitor tag on each screen can be specified.

The CX-Process Monitor tag file is created by selecting **Create Tag File – Monitor Tag** from the Execution Menu.

- Note**
1. It is necessary to install the CX-Process Monitor on the same computer before creating monitor tag files.
 2. Monitor tag files are stored by default in the following folder with fixed file names.
Folder: Omron\CX-Process Monitor\db
(The underlined part is the folder of CX-Process Monitor.)
File names: mtagmst and mtagsubmst
You can change the folder in which monitor tag files are stored using the Monitor Software from the Setup Dialog Box.
 3. CX-Process Monitor tag files are not used when comparing, downloading, or uploading data.

CX-Process Monitor Plus Tag Files (monitor.csv) (CX-Process Tool Ver. 3.2 or Higher)

A CX-Process Monitor Plus tag file contains the CX-Process Monitor Plus tag data for a single CPU Unit (with a maximum of three Loop Control Units).

CX-Process Monitor Plus tag data consists of tag names, tag comments, corresponding ITEM numbers or block addresses, and analog signal scaling data. By reading the tag file with the CX-Process Monitor Plus, the block address or ITEM number in function block data corresponding to the CX-Process Monitor tag on each screen can be specified.

The CX-Process Monitor tag file is created by selecting **Create Tag File – Monitor Plus Tag** from the Execution Menu. If the CX-Process Monitor Plus is then started and the **Start** Button is pressed, the monitor tag files *mtagmst* and *mtagsubmst* will be automatically generated. If the monitor tag files are read from the CX-Process Monitor, the block addresses or ITEM numbers in the function block data corresponding to the monitor tag names pasted on the screen can be selected.

- Note**
1. It is necessary to install the CX-Process Monitor Plus on the same computer before creating monitor tag files.
 2. CX-Process Monitor tag files are stored by default in the following folder with fixed file names.
Folder: Omron\CX-Process Monitor Plus\db
 3. CX-Process Monitor Plus tag files are not used when comparing, downloading, or uploading data.

CSV Setting File (project_name.csv)

The CSV setting file contains the CSV tag settings required to output a CSV tag file for SCADA software. This data is automatically generated in advance by the system. It can be edited by the user using Excel or another editor.

The file contains the tag names, tag comments, scaling upper limits, scaling lower limits, scaling decimal point, units, and other settings for each function block. The data is comma delimited.

Note This file does not contain the tags for individual ITEMS in function block or address allocations for CPU Unit I/O memory. (These are stored in the CSV tag files for SCADA software after the CSV tags have been compiled.)

This file is automatically generated after CSV tag settings have been made after selecting **Settings – Tag Setting – CSV Tag** or (for CX-Process Tool software version 3.1 or higher) when function blocks are saved in function block files after selecting the automatic CSV tag registration option when registering function blocks.

This file is saved in the data project folder under the CS-Process installation folder as *project_name.csv*.

The CSV automatic tag registration function can be used with version 3.1 or higher to automatically save CSV tag settings in this file when function blocks are registered. The tag name will be Tag + block address, the scaling upper limit will be 1,000, and the scaling lower limit will be 0.

If this file is edited with Excel or another editor and overwritten, the new settings will be read when the project is opened.

CSV Tag Files for SCADA Software (.csv, Default File Name: TagList.csv)

A CSV tag file can contain CSV tag data for up to 32 CPU Units (i.e., up to 96 Loop Control Units and 32 LCB□□s).

CSV tag data consists of comma-delimited test data containing tag names, numbers, tag comments, block addresses, tag ITEMS, and allocated I/O memory addresses (in CPU Unit).

The CSV tag file can be read from SCADA software via an OMRON OPC Server to specify block addresses and ITEM numbers in the function block data of the Loop Controller.

Settings – Tag Setting – CSV Tag is used to set CSV tags for each function block, and *Execute/Create Tag File/CSV Tag* is used to allocate I/O memory addresses in the CPU Unit and compile a CSV tag file.

Note

1. CSV tag files are not downloaded, uploaded, or compared.
2. Basically speaking, CSV tag files are imported to SCADA software through an OMRON OPC server.

Tag Files for RS View (.csv, User-set File Name)

An RS View tag file can contain CSV tag data for up to 32 CPU Units (i.e., up to 96 Loop Control Units and 32 LCB□□s) for direct importing into RS View 32. Any file name can be specified.

The RS View tag file can be directly imported using the RS View import utility. This file is created together with the SCADA CSV tag file when the RS View CSV tags are compiled using *Execute/Create Tag File/RS View Tag*. When this file is imported into the RS View 32 using the import utility, the ITEMS and tags specified with CSV tag settings are registered in the tag database in the RS View 32 project.

Note

1. RS View tag files are not downloaded, uploaded, or compared.
2. The SYSMAC OPC Server Version 2.40 or higher is required to generate an RS View tag file from the CX-Process Tool.

Comment Files (.cmt)

A comment file contains of the tag data attached to a function block connection diagram or step ladder diagram.

The file name is automatically set to the same name as the project.

CX-Server Settings File (.cdm)

This file contains the communications settings for communications with the PLC when CX-Server is being used as the communications driver.

The file name is automatically set to the same name as the project.

Job Information Files (.sjb)

The job information file consists of data on the registration of jobs for Project Workspace.

The file name is automatically set to the same name as the project.

Loop Controller Configuration Files (.lcb)

The Loop Controller configuration file is a system file that includes data on the existence of Loop Controllers in the project.

Data Files of User Link Tables (CSV Format) (LnkTable.csv) (LCB□□ Only)

The data file of user link table consists of user link table data that can be edited by the user. If this file is edited using Excel, for example, the editing results will be reflected in the user link table when the project is opened or when the active node is switched.

Data Files of Sequence Tables (.stbl)

The data file of sequence table consists of sequence table data.

1-1-4 Relationships between Tag Files

The relationships between the tag files created by the CX-Process Tool and the HMI applications that use these files are shown below. The HMI applications that use the tag files include NS-series PTs, SCADA software, the CX-Process Monitor, and the CX-Process Monitor Plus.

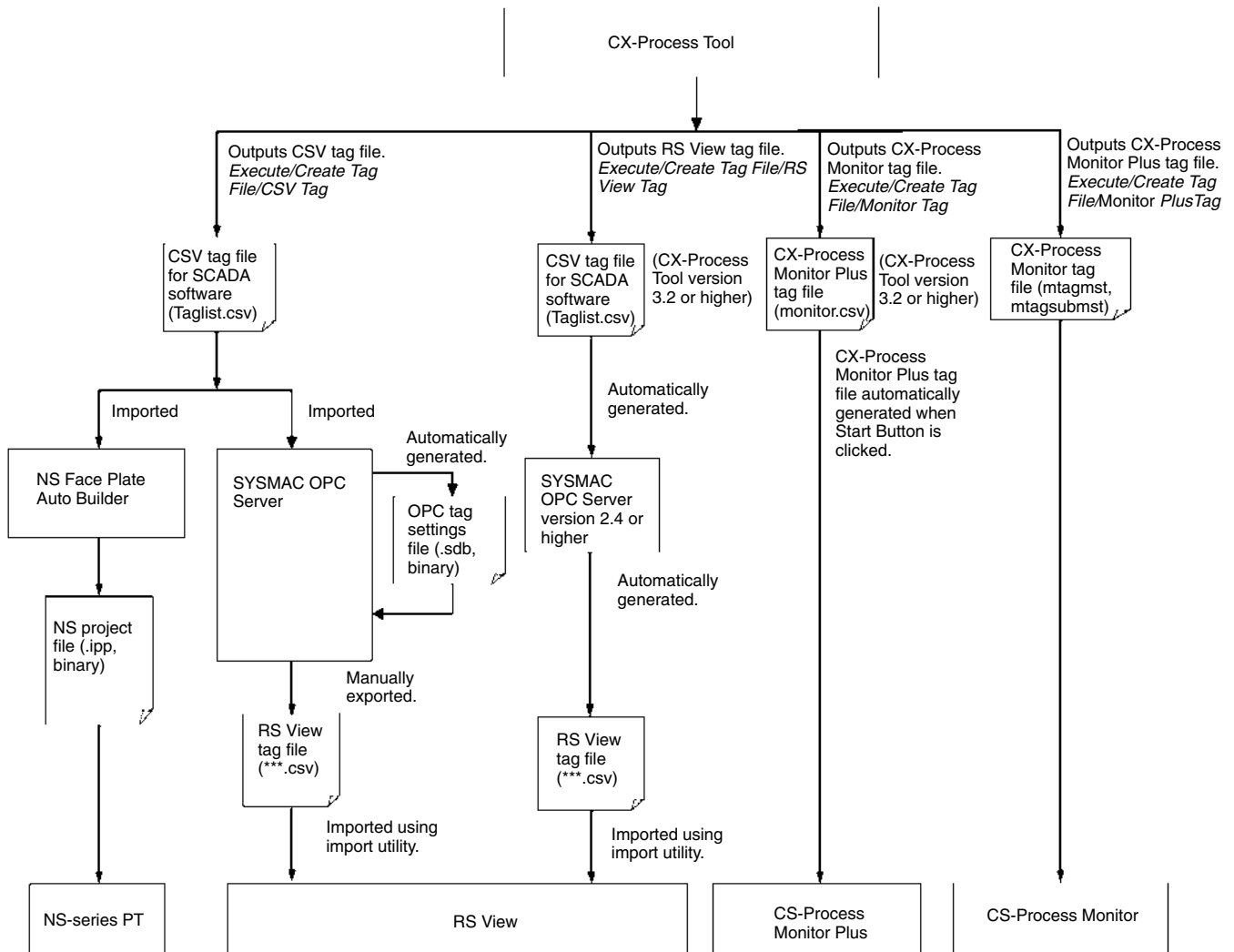

1-1-5 Operating Conditions of CX-Process Tool

As shown below, the CX-Process Tool uses a FinsGateway (Embedded), Version 2003, or CX-Server communications driver to communicate with the PLC (Programmable Controller) to which a Loop Controller is mounted. It is thus necessary to install the FinsGateway (Embedded), Version 2003, or CX-Server software in the personal computer that will be used.

Note When the CX-Process Tool starts up, a dialog box is displayed to select whether FinsGateway or CX-Server will be used as the communications driver.

Using FinsGateway

The following FinsGateway (Embedded) communications drivers are available.

- Serial Unit Driver
- CLK (PCI) Driver
- Controller Link Driver
- ETN_UNIT Driver

The software configuration is shown below.

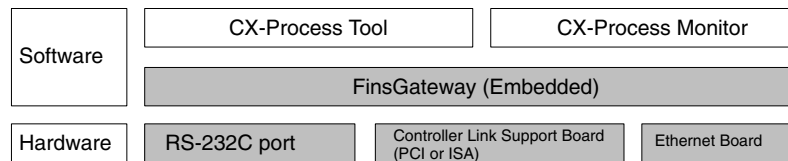

- Note**
1. If FinsGateway (Embedded) has not been installed, it will not be possible to set FinsGateway as the communications driver and start the CX-Process Tool. Likewise, if CX-Server has not been installed, it will not be possible to set CX-Server as the communications driver and start the CX-Process Tool.
 2. The CX-Process Tool cannot use FinsGateway version 1 as the communications driver. Use FinsGateway version 3 or later.
 3. If any other Support Software (e.g., the CX-Programmer, CX-Protocol, or CX-Motion) is connected over the CX-Server or an application using the dedicated serial driver is connected, the same COM port cannot be initialized for online Host Link serial communications for the CX-Process Tool. Disconnect the other Support Software or the application using the dedicated serial driver offline, and then go online with the CX-Process. (While the CX-Process Tool is connected online, no other Support Software can communicate via the CX-Server.)
 4. The CX-Process Tool and FinsGateway Version 1 cannot be installed on the same computer.
 5. The CX-Process Tool runs on Windows NT 4.0 (with Service Pack 6a or higher).
 6. FinsGateway version 3 and FinsGateway 2003 (Embedded) are bundled together with the CX-Process Tool. If the FinsGateway Runtime version 3 has been already installed, there is no need to install the FinsGateway embedded version.

Using CX-Server

The CX-Server is a communications driver shared by the following OMRON Tools:

- CX-Programmer
- CX-Protocol
- CX-Motion

The CX-Server has the following advantages:

- If the CX-Server is being used, one of the three Tools listed above can be started at the same time as the CX-Process Tool and simultaneous online connections can be established with the same PLC through the same COM port on

the personal computer. The simultaneous online connections make it unnecessary to switch between communications drivers or switch the Tools between online/offline operation.

- If the CX-Server is being used, Peripheral Bus mode can be used as a serial communications mode. The Peripheral Bus mode provides even faster communications than Host Link mode.

Note The CX-Process Monitor software is not compatible with the CX-Server; it is compatible with the FinsGateway only. The following diagram shows the software configuration.

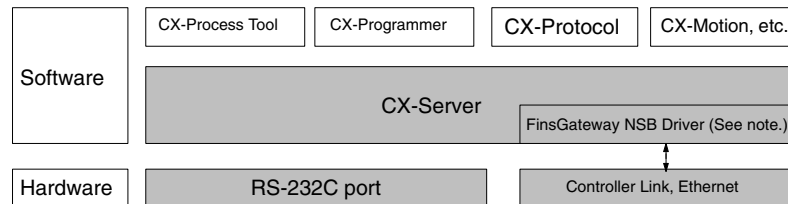

Note The CX-Server can be connected to other networks, such as Controller Link and Ethernet, through the FinsGateway NSB driver.

1-2 Relationship with CX-Process Monitor

1-2-1 Overview of the CX-Process Monitor and CX-Process Monitor Plus

The CX-Process Monitor is used to monitor function blocks in Loop Controllers. The CX-Process Monitor does not support the LCB□□s. The CX-Process Monitor Plus is used to monitor function blocks in LCB□□s. A connection can be made through Host Link, Controller Link, or Ethernet so that the data can be monitored on the Control Screens (like on-site instruments), Trend Screens, Graphic Screens, or Annunciator Screens. The CX-Process Monitor and CX-Process Monitor Plus are used in combination with the CX-Process Tool.

The CX-Process Monitor and CX-Process Monitor Plus have the following three main functions.

Monitoring Status of Function Blocks in Loop Controllers

Control Block PVs, SPs, MVs, analog signals, and contact signals can be monitored.

Loop Controllers can be started and stopped.

The status of the CPU Unit, such as the operating mode, can be displayed.

Manipulating Function Blocks in Loop Controllers

In Control Blocks, settings can be changed, automatic or manual operation can be selected, manual control is possible, and PID constants can be adjusted.

It is possible to stop the processing of specific Control Blocks on a Tuning Screen.

Monitoring Alarms in Function Blocks in Loop Controllers

Alarms from Control and Alarm Blocks can be displayed and alarm logs can be saved.

Note The CX-Process Monitor and CX-Process Monitor Plus use FinsGateway as the communications driver for connections with the PLC. When using the CX-Process Monitor or CX-Process Monitor Plus, always set FinsGateway as the communications driver for the CX-Process Tool. If the CX-Server is set, the CX-Process Monitor or CX-Process Monitor Plus will not be able to go online with the PLC.

1-2-2 Settings Required on the CX-Process Tool

The CX-Process Monitor and CX-Process Monitor Plus use tag names set on the CX-Process Tool to read and write data in Loop Control Units through func-

tion blocks for data exchange with the monitor software. Before using the CX-Process Monitor or CX-Process Monitor Plus, the following settings must be made with the CX-Process Tool.

CX-Process Monitor

Set Network Address, Node Address, and Unit Address.

The CX-Process Monitor uses the network address, node address, and unit address set using the CX-Process Tool (**Setting – Network Settings** or **Setting – Change PLC**) for communications with the PLC. The communications settings for the CX-Process Monitor Plus are thus made from the CX-Process Tool.

Register Function Blocks for Data Exchange.

Create a Send Terminal to Computer Function Block or certain other function blocks (with a block model between 401 and 404) with the CX-Process Tool to specify the function block, the analog signals (including parameters), or the contact signals (including parameters) as the source for data exchange with the computer. Also, create AO Terminal Settings from Computer or DO Terminal Settings from Computer Function Block to enable receiving analog signals or contact signals from the computer.

Set Tag Names.

Using the CX-Process Tool, set tag names for the function blocks, analog signals (including parameters), or contact signals (including parameters) specified as sources. Also, set tag names for the analog or contact outputs of the AO Terminal Settings from Computer or DO Terminal Settings from Computer Function Blocks. It is also necessary to set the zero point, span point, decimal place, and scaling of engineering units.

Create a Monitor Tag File for CX-Process Monitor.

Create the monitor tag file to transfer the created tag data to the CX-Process Monitor. The CX-Process Monitor must be installed before creating the monitor tag file.

Download Function Block Data to Loop Control Unit.

Download the function blocks.

CX-Process Monitor Plus

Set Network Address, Node Address, and Unit Address.

The CX-Process Monitor Plus uses the network address, node address, and unit address set using the CX-Process Tool (**Setting – Network Settings** or **Setting – Change PLC**) for communications with the PLC. The communications settings for the CX-Process Monitor Plus and thus made from the CX-Process Tool.

Register and Connect Function Blocks To Exchange Data with CX-Process Monitor Plus.

The function blocks used to exchange data with the CX-Process Monitor Plus must be registered and connected. Register the following blocks for the items to be monitored.

| Item | Loop Control Unit | LCB□□ |
|---------------------------------|--|--|
| Function block data to exchange | Send All Blocks block (Block Model 462) and Receive All Blocks block (Block Model 461) | HMI settings in the System Common block (Block Mode 000) |
| Contact signals to exchange | Contact Distributor (Block Model 201) or Internal Switch (Block Model 209) | |
| Analog signals to exchange | Input Selector block (Block Model 162) and Constant Generator block (Block Model 166) | |

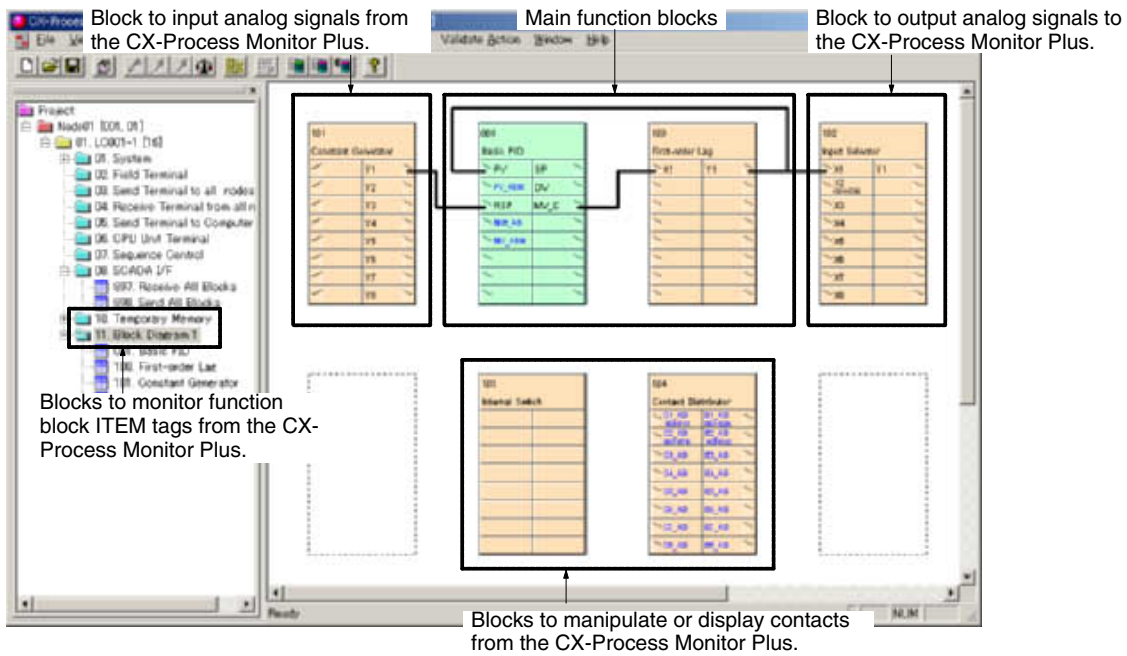

Set CSV Tags and Tags for CX-Process Monitor Plus.

Loop Control Units

1, 2, 3...

1. Register the Send All Blocks block (Block Model 642) and Receive All Blocks block (Block Model 641).
2. Set tags as follows:
 - Function block data: Set CSV tags.
 - Individual contact signals: Set CX-Process Monitor Plus tags for the contacts in the Internal Switch block (Block Model 209).
 - Individual analog signals from LCB element to computer: Set CX-Process Monitor Plus tags for the analog signals in the Input Selection block (Block Model 162).
 - Individual analog signals from computer to LCB element: Set CX-Process Monitor Plus tags for the analog signals in the Constant Generator block (Block Model 166).

LCB□□s

1, 2, 3...

1. Make the settings for the HMI in the System Common block (Block Model 000).
2. Set tags as follows:
 - Function block data: Set CSV tags.
 - Individual contact signals: Set CX-Process Monitor Plus tags for the contacts in the Internal Switch block (Block Model 209).
 - Individual analog signals from LCB element to computer: Set CX-Process Monitor Plus tags for the analog signals in the Input Selection block (Block Model 162).
 - Individual analog signals from computer to LCB element: Set CX-Process Monitor Plus tags for the analog signals in the Constant Generator block (Block Model 166).

Note For any Loop Controller, the following function blocks must be created and connected separately to enable monitoring and setting individual contact signals and individual analog signals (i.e., other than function block data).

- To monitor and set individual contact signals, contact signals must be input/output using the Contact Distributor block (Block Model 201) and Internal Switch block (Block Model 209).
- To monitor individual analog signals, analog signals must be output from the Input Selection block (Block Model 162).
- To set individual analog signals, analog signals must be input to the Constant Generator block (Block Model 166).

Generate CX-Process Monitor Plus Tag File.

Generate the CX-Process Plus tag file using **Execute – Create Tag File – Monitor Plus Tag**.

Download Function Block Data to Loop Controller.

Download the function blocks.

Compile the Monitor Tag Files.

Start the CX-Process Monitor Plus and click the **Start** Button or the **Setup** Button. The monitor tag files (mtagmst and mtagsubmst) will be automatically generated based on the CX-Process Monitor Plus tag file (monitor.csv).

Setting Initial Data ITEMS

The CX-Process Tool is normally used to set initial data S and the CX-Process Monitor is normally used to set operation data O.

| Data classification | Type | ITEM | Example: PID Block | CX-Process Tool | CX-Process Monitor |
|---------------------|------|---|---|----------------------|--------------------|
| Initial settings | S | Initial setting parameter for each function block | Forward/Reverse direction, SP setting method, compensation method, etc. | Set | Cannot be set |
| Operation data | O | Operation parameters for each function block | Example: PID Block SP, alarm settings, PID constants, etc. | Set in special cases | Set |

Note Initial settings S and operation data O classifications are displayed on ITEM Setting Screens of the CX-Protocol Tool. For details on the ITEMS set in each function block, refer to the *Function Block Reference Manual*.

Example

| ITEM type | ITEM | Contents | R: Read, W: Write, R/W: Read/write, ---: R/W disabled r, t/w: CX-Process Tool operation monitor/Operation monitor read and write (S): Initial setting, (O): Operation data | |
|-----------|------|--|--|--------------------|
| | | | CX-Process Tool | CX-Process Monitor |
| Parameter | 004 | Operation cycle (s) | R/W (S) | --- |
| Parameter | 008 | High/Low alarm | R/W (O) | R/W |
| | 012 | Hysteresis set value | R/W (S) | --- |
| Parameter | 023 | Local SP set value | R/W (O) | R/W |
| | 024 | SP set method (Initial setting) 0: Local, 1: Remote/Local | R/W (S) | R |

Note Analog values are normally set with the CX-Process Monitor. They can be set with the CX-Process Tool provided that they are in percentage increments between 0% and 100%. Scaling engineering units cannot be set with the CX-Process Tool.

1-3 CX-Process Tool Specifications

CX-Process Tool Specifications

| Item | | Specification | |
|--|--|---|--|
| Product name | | CX-Process Tool | |
| Model | | WS02-LCTC1-EV5 | |
| Applicable PLCs | | CS/CJ-series PLCs | |
| Applicable Units/Boards | | Loop Control Units, Loop Control Boards, Process-control CPU Units, Loop-control CPU Units | |
| Applicable computer | Computer | IBM PC/AT or compatible | |
| | CPU | Intel CPU (Core, Pentium, or Celeron family) For Windows Vista: 1 GHz min. For any other OS: 333 MHz min. required, 1 GHz min. recommended | |
| | OS | Microsoft Windows Vista Ultimate or Business, XP Professional (up to Service Pack 2), 2000 Professional (Service Pack 3 or higher), ME, NT Workstation (Service Pack 6a or higher), 98 SE (See note 1.) | |
| | Supported languages | English | |
| | Memory | For Windows Vista: 1 GB min. For any other OS: 256 MB min. required, 512 MB min. recommended | |
| | Hard disk space | Min. required: 350 Mbytes of free space, Recommended: 450 Mbytes or more of free space (including approx. 280 Mbytes used by communications middleware) | |
| | Monitor | Min. required: XGA, 256 colors; Recommended: SXGA, 65,536 colors min. | |
| | CD-ROM drive | At least one | |
| | Mouse | Recommended: Microsoft mouse or compatible pointing device | |
| Software that must be installed with the CX-Process Tool | | CX-Server or FinsGateway | |
| Connecting method | Connection with CPU Unit (or Serial Communications Board/Unit) | Using FinsGateway Serial Unit Driver | Communications protocol with PLC: Host Link (A peripheral bus (toolbus) connection cannot be used.) <ul style="list-style-type: none"> Connect the computer to the peripheral port or built-in RS-232C port of the CPU Unit, or the RS-232C port of a Serial Communications Unit/Board. Connecting cable: When connecting to the CPU Unit peripheral port: CS1W-CN□□□ (2 m, 6 m) When connecting to the CPU Unit's RS-232C port: XW2Z-□□□-□ (2 m, 5 m) (For details on model numbers, see 1-6-4 <i>Connecting Cables</i>) |
| | | Using CX-Server | Communications protocol with PLC: Host Link or Peripheral Bus (The compatible connecting cables are the same as the ones shown above for the FinsGateway connection.) |
| | Connection via Controller Link | Using FinsGateway CLK (PCI) Driver | Install the driver in a computer equipped with a Controller Link Support Board (PCI slot) to support communications between the computer and PLCs equipped with a Controller Link Unit. |
| | | Using FinsGateway Controller Link Driver or CX-Server | Install the driver in a computer equipped with a Controller Link Support Board (ISA slot) to support communications between the computer and PLCs equipped with a Controller Link Unit. |
| Connection via Ethernet | Using FinsGateway ETN_UNIT Driver or CX-Server | Install the driver in a computer equipped with an Ethernet to support communications between the computer and PLCs equipped with an Ethernet Unit. | |

| Item | Specification |
|-----------------------------|--|
| Files that are created | <p>The following files are created in the project folder.</p> <ul style="list-style-type: none"> • Multi-node files (.mul) for Project Workspace: Created by user. • Function block files (.ist) consisting of initial set data and operation data: Created by the system. • Block diagram information files (.mtbd): Created by the system. • Mnemonics/ladder diagram information files (.mtld): Created by the system. • Monitor tag files (with fixed file name without extension): Created by user. • Job information files (.sjb): Created by the system. • Comment files (.cmt): Created by the system. • CX-Server Settings file (.cdm): Created by the system. • CSV tag settings file (<i>project_name.csv</i>): Created by system; can be edited by user. • CSV tag files (.csv) for SCADA software: Created by user. • Files for Loop Controllers (.lcb): Created by the system. • User link table files in CSV format (LinkTable.csv): Created by the user. • Sequence table files (.sbl): Created by the system. • User-defined block files (<i>User-defined_block_name.ucb</i>): Created by the user. • Sequence table operation validation and online editing/elements (timers and counters) set value change and present value display files |
| Offline operation functions | <ul style="list-style-type: none"> • Setting of function block ITEM data (including System Common block settings) • Software wiring of analog signals • Displaying or printing the arbitrary text (tags) attached to block connection diagrams and ladder diagrams • Displaying connection maps (showing the I/O relationships of a function block) • Editing user link tables • Creating sequence tables • Description of Step Ladder Program block commands • Setting of tags for CX-Process Monitor (on block designated as the source in the Send to Computer block, contacts and analog signals) • Backing up function block data from RAM to flash memory or restoring function block data from flash memory to RAM. • Converting LCU/LCB element data between different models of Loop Controller. |
| Online operation functions | <p>Downloading of function block data (download/upload to and from Loop Controllers)</p> <p>Comparing between node function block files (including mnemonics) and Loop Controllers</p> <p>Run/stop command for Loop Controllers (all function blocks)</p> <p>System monitor run status: Monitoring/manipulation of System Common block (Block Model 000) (including monitoring of load rate of function blocks in each operation cycle group)</p> <ul style="list-style-type: none"> • Loop Controller monitor run status: Confirmation of function block wiring operation (including operation stop/stop cancel on each function block), confirmation of Step Ladder Program operation <p>Changing SPs and tuning parameters such as PID constants in function blocks (Control Blocks)</p> <ul style="list-style-type: none"> • Initializing RAM in the Loop Controller. • Backing up function block data from RAM to flash memory in the Loop Controller block and restoring the data to RAM. • Creating I/O tables (online only) • Setting the PLC Setup • Changing the CPU Unit's operating mode |

Note The Windows Vista 64-bit version and Windows XP x64 Edition are not supported.

1-4 Version Improvements

1-4-1 Version 1.20

The improvements made from version 1.00 to version 1.20 of the CX-Process Tool are listed in the following table.

| Item | | Ver. 1.00 | Ver. 1.20 |
|---|----------------------|---|--|
| Maximum number of function data nodes (CPU Racks) that can be created | | 1 node | 31 nodes max. |
| File creation | | Function files (.ist) and related files | Multi-node files (.mul) and related files (node function files (.ist), etc.) (See note.) |
| Location of created files | | User-set | Limited to the project folder in CX-Process\data |
| Project tree | | In order: Project Workspace-LCU/LCB element-function block group-function block | In order: Project Workspace-node function file -LCU/LCB element-function block group -function block |
| Conditions in which monitor tag compilation is possible | | Not possible with Windows 95/98 | Possible with Windows 95/98 |
| Function blocks that can be created | | Not compatible with Loop Control Unit Ver. 1.20 | Compatible with creation of the following new Ver. 1.20 Loop Control Unit function block: 2-position ON/OFF (Block Model 001), 3-position ON/OFF (Block Model 002), Blended PID (Block Model 013), 3-input Selector (Block Model 163), 3-output Selector (Block Model 164), Batch Data Collector (Block Model 174), DI Terminal from Expanded CPU Unit (Block Model 455), DO Terminal from Expanded CPU Unit (Block Model 456), AI Terminal from Expanded CPU Unit (Block Model 457), AO Terminal from Expanded CPU Unit (Block Model 458) |
| Printing units | Block diagrams | 1 block diagram | 1 or all registered block diagrams |
| | Step ladder diagrams | 1 step ladder diagram | 1 or all registered step ladder diagrams |
| Downloading separate function blocks while Loop Control Unit is operating | | Not possible (you must stop the Loop Control Unit to download) | Possible |
| Changing block address for registered function blocks | | Not possible | Possible (you can also add 1) |

Note You can also import block files (.ist) created using Ver. 1.00.

1-4-2 Version 1.50

The improvements made from version 1.20 to version 1.50 of the CX-Process Tool are as follows:

| Item | Ver. 1.20 | Ver. 1.50 |
|-------------------------------------|---|--|
| Function blocks that can be created | Not compatible with Loop Control Unit Ver. 1.50 | <p>Compatible with the creation of following new function blocks with the Ver. 1.50 Loop Control Units: Segment Program 2 (Block Model 157), Accumulated Value Input Adder (Block Model 182), Accumulated Value Input Multiplier (Block Model 183), Constant Comparator (Block Model 202), Variable Comparator (Block Model 203), Clock Pulse (Block Model 207), ON/OFF Valve Manipulator (Block Model 221), Motor Manipulator (Block Model 222), Reversible Motor Manipulator (Block Model 223), Motor Opening Manipulator (Block Model 224)</p> <p>Compatible with the following new Loop Control Unit Ver. 1.50 ITEM creations: AT (auto-tuning) functions of Basic PID block (Block Model 011) and Advanced PID (Block Model 012), and wait function and additional steps (step numbers 8 to 15) of the Ramp Program block (Block Model 155)</p> |
| Printing functions | Except for function blocks, only open block diagrams, ladder diagrams, and cross-references can be printed. | <ul style="list-style-type: none"> You can print block diagrams, ladder diagrams, and cross-references by LCU element or node, even if they are not open. You can print monitor tag lists. You can print all data by LCU element or node. |
| Monitor tag list display function | None | Possible (displays the monitor software tag information that has been set) |
| Search function | None | Possible (searches for block address or monitor software tag name, and moves the cursor to the matching function block) |
| Version check function | None | Possible (checks for version compatibility between the Loop Control Unit connected online and CX-Process Tool in use) |

1-4-3 Version 2.00

The improvements made from version 1.50 to version 2.00 of the CX-Process Tool are listed in the following table.

| Item | Ver. 1.50 | Ver. 2.00 |
|---|--|--|
| New function blocks | Does not support Loop Control Unit version 2.00 | ES100X Controller Terminal (Block Model 045), 4-point Warning Indicator (Block Model 110), Arithmetic Operation (Block Model 126), Time Sequence Data Statistics (Block Model 153), Receive All Blocks (Block Model 461), and Send All Blocks (Block Model 462). |
| | | ITEMs added for other function blocks. Refer to the <i>Loop Control Unit Operation Manual</i> for details. |
| Editing block diagrams | Lines disappear when pasted function blocks are moved. | Lines do not disappear when pasted function blocks are moved. |
| | Lines must be deleted individually. | All the lines connected to specified function blocks or ITEMs can be deleted at the same time. |
| | Block connection diagrams cannot be copied. | Block connection diagrams can be copied and registered to new Loop Control Unit nodes. |
| Editing ladder diagrams | Cut, copy, and paste not supported. | Cutting, copying, and pasting are possible for symbols, areas, and lines. |
| Undo | Not supported. | The previously executed operation can be undone. |
| Compiling CSV tags for SCADA software | Not supported. | CSV tags can be set for function blocks and CSV tags can be compiled, saved, and displayed accordingly. |
| Function block data backup and recovery | Not supported. | Function blocks in RAM in the Loop Control Unit can be backed up in flash memory in the Loop Control Unit or the data in flash memory can be restored to RAM. |
| ITEM List Monitoring | Not supported. | ITEM data for a specified function block can be monitored in a list. |
| Find Loop Control Unit | Not supported. | Loop Control Units on networks connected to the PLC to which the CX-Process Tool is connected can be found and addresses can be set in node function block files. |
| Download, upload, and compare | Block diagram information files (extension: .mtbd) cannot be uploaded or downloaded. | Block diagram information files (extension: .mtbd) can be uploaded or downloaded. |

1-4-4 Version 2.50

The improvements made from version 2.00 to version 2.50 of the CX-Process Tool are listed in the following table.

| Item | Ver. 2.00 | Ver. 2.50 |
|--|---|---|
| New function blocks | Does not support Loop Control Unit version 2.50 | Fuzzy Logic (Block Model 016), Range Conversion (Block Model 127), Ramped Switch (Block Model 167), Level Check (Block Model 210), AI4 Terminals (DRT1-AD04) (Block Model 588), AO2 Terminals (DRT1-DA02) (Block Model 589) |
| Communications drivers | FinsGateway only | FinsGateway or CX-Server can be selected as the communications driver. When CX-Server is selected, both CX-Programmer and the CX-Process Tool can be started simultaneously (sharing the communications driver CX-Server). Also, the computer can be connected through the PLC's Peripheral Bus. |
| Tuning Screen | Not supported. | Added the Tuning Screen that could previously be used with CX-Process Monitor only in lower versions. This screen allows parameters such to be adjusted from the CX-Process Tool. For example, PID constants and SPs can be adjusted in the Basic PID Block. Also, the Fuzzy Logic Block can be displayed only in this version of the CX-Process Tool. |
| Download individual ITEM data | Not supported. | When the CX-Process Tool is online and a function block's ITEM has been set, it is possible to download just that ITEM's data (operation data only) to the Loop Control Unit by clicking the Download Button. For example, this function can be used for the AT command (autotuning) from the Basic PID Block or Advanced PID Block. |
| Annotations (comments) | Not supported. | It is now possible to insert comments at any point in the diagram when operating in Block Diagram Edit Mode or Ladder Diagram Edit Mode. This function allows user-set names to be displayed and printed (useful for schematic diagrams) next to commands in function blocks or step ladder programs. |
| Copy function block | Not supported. | Function block units can be copied/cut/pasted in the Project Workspace. |
| Automatic assembly and disassembly of step ladder programs | Not supported. | Step ladder programs (Block Model 301) can be automatically assembled (converted from ladder diagram to mnemonic code) when they are downloaded and automatically disassembled (converted from mnemonic code to ladder diagram) when they are uploaded. (The Mnemonic Flag specifies whether a program can be converted to ladder diagram format.) |

1-4-5 Version 3.00

Note The improvements made from version 2.50 to version 3.00 of the CX-Process Tool are listed in the following table.

| Item | | Ver. 2.50 | Ver. 3.00 |
|---|-----------------------------------|---|--|
| Applicable Units/Boards | | Loop Control Units | Loop Control Units and Loop Control Boards |
| New functions for Loop Control Boards | User link tables | Not supported. | Supported, along with the following. Automatic registration of Field Terminals to user link tables Copying and pasting software links for user link table function blocks Outputting user link table tags in CSV format (attached to HMI data tags) Importing local symbol tables from the CX-Programmer |
| | Sequence tables (Block Model 302) | Not supported. | Supported (Operation can also be validated.) |
| New function blocks | | --- | Sequence Table (Block Model 302) and Ao Terminal (PMV02) (Block Model 565) (Supported by the CS1W-LCB05 Loop Control Board only.) |
| Function block registration methods | | Registering function blocks with the Function Block Navigator and then pasting them | In addition to the V2.50 method, function blocks can also be specified and pasted directly on the block diagrams. (Function blocks can be specified after right-clicking on the block diagram.) |
| Connection maps | | Not supported. | Supported A diagram of the I/O relationships for one block can be displayed after selecting the block. |
| Conversion of LCU/LCB element data between Loop Controller models | | Not supported. | CS1W-LCB01 Loop Control Board data can be converted to CS1W-LCB05 Loop Control Board data. CS1W-LC001 Loop Control Unit data can be converted to CS1W-LCB01 or CS1W-LCB05 Loop Control Board data. |
| Downloading block diagram information | | Not supported. | When downloading individual function blocks, layout information for the block from the block diagram can also be downloaded. |
| Controlling CPU Unit operation | | Not supported. | If the CX-Server is specified as the communications driver, I/O tables can be created, the PLC Setup can be set, and the CPU Unit's operating mode can be controlled. |
| Data monitoring refresh cycle for PVs, SPs, alarms, and other data on Tuning Screens | | 1 s only | Either 1 s or 200 ms can be selected. (A red warning display will appear when the data could not be refreshed within the specified cycle.) |
| Connection specifications on block diagrams other than software connections (Right-clicking blue ITEMS and inputting addresses) | | Input only of block addresses and ITEM numbers (BBBIII) | In addition to block addresses and ITEM numbers (BBBIII), the connection destination can be specified from a pull-down menu when using a Loop Control Board. |

1-4-6 Version 3.1

The improvements made from version 3.0 to version 3.1 of the CX-Process Tool are listed in the following table.

| Item | Ver. 3.0 | Ver. 3.1 |
|-------------------------|---|--|
| Unit/Board support | CS1W-LC001 Loop Control Unit and CS1W-LCB01/05 Loop Control Boards | CS1D-CPU□□P Process-control CPU Units (in addition to CS1W-LC001 Loop Control Unit and CS1W-LCB01/05 Loop Control Boards) |
| Data conversion | Conversion from LCU element to LCB element data | Conversion of data created for the CS1W-LCB05 to CS1D-CPU□□P Process-control CPU Unit (in addition to conversion from LCU element to LCB element data) |
| CSV tag settings | Manually only (making settings individually in the CSV Tag Settings Dialog Box) | Automatically creating CSV tag settings when registering function blocks (CSV tag setting function) and editing in Excel or other editor before loading to the project (in addition to manual setting) |
| Backup during operation | Not supported. | Supported. |

1-4-7 Version 3.2

The improvements made from version 3.1 to version 3.2 of the CX-Process Tool are listed in the following table.

| Item | Ver. 3.1 | Ver. 3.2 | |
|---|--|--|---|
| User-defined block | Not supported. | Supported. (Registers a group of function blocks as a single user-defined function block.) | |
| RS View tag files (.csv) | Not supported. (The CSV tag file must be imported to an OPC server and then the RS View tag file (.csv) has to be created manually.) | Supported. (The RS View tag file (.csv) can be automatically and directly generated.) | |
| OPC server direct access tag output | Not supported. | Supported. ITEMS other than HMI data can be output for OPC server direct access when the CSV tags are compiled. (Applies only to the following: Ramp Program (Block Model 155), Segment Program (Block Model 156), and Segment Program 2 (Block Model 157).) | |
| HMI memory map CSV output | Not supported. | Supported. The allocations of HMI memory can be output to a CSV file. The file shows which words in the EM Area are allocated to tags and tag ITEMS. | |
| Tuning screens | Multiple screens | Not supported. (Only one screen can be open.) | |
| | Data logging (saved to CSV file) | Not supported. | Supported. (Logging is started when the tuning screen is opened and continues until the tuning screen is closed.) |
| Setting of number of communications retries | Not supported. | Supported. | |
| Sequence table | Online editing | Not supported. | Supported. |
| | Displaying PV and changing set value for timers and counters | Not supported. | Supported. |

| Item | Ver. 3.1 | Ver. 3.2 |
|------------------|---|--|
| Monitor software | CX-Process Monitor (CX-Process Monitor Plus cannot be used.) | CX-Process Monitor or CX-Process Monitor Plus |

1-4-8 Version 4.0

The improvements made from version 3.2 to version 4.0 of the CX-Process Tool are listed in the following table.

| Item | Details |
|--|--|
| Support for CJ1G-CPU□□P Loop-control CPU Units and LCB01/05 version 2.0 | The following new functions are supported: Simple backup of the Loop Controller's function block data to the Memory Card Selecting the step to restart Segment Program 2 (Block Model 157) to match the first or second reference input Synchronization of Segment Program 2 (Block Model 157) Setting hot start time Reset wind up protection of secondary loop of cascade control Setting range 0.00% to 100.00% for input signals in Split Converter (Block Model 169) Addition of Field Terminal Blocks (Ai4 terminal (PTS51/52), Ai8 terminal (PTS55/56), Ao2 terminal (DA021), and Ai4/Ao2 terminal (MAD42) |
| Displaying Loop Controller memory map | The status showing how the Loop Controller is using CPU Unit memory can be displayed as a list. |
| Backing up to and recovering from Memory Card project comments, annotations, tags, and connection data | Comments, annotations, tags, and connection data, which previously could not be saved in the Loop Controller, can now be saved in the Memory Card installed in the CPU Unit. This enables comments, annotations, tags, and connection data included in function block data to be uploaded from the Loop Controller. |
| Support for SYSMAC OPC Server version 2.6 scaling functions | The scaling functions from SYSMAC OPC Server version 2.6 have been expanded. The expanded scaling information for CSV tags can be exported to the SYSMAC OPC Server version 2.6. |
| Starting the NS Faceplate Auto Builder | The Faceplate Auto-Builder for NS can be executed in the sequence of operations when compiling CSV tags from the CX-Process Tool. Using this method, the folder for the created CSV tag file will be automatically specified in the parameter setting screen that is displayed when the Faceplate Auto-Builder for NS starts. |

1-4-9 Version 4.1

The improvements made from version 4.0 to version 4.1 of the CX-Process Tool are listed in the following table.

| Item | Ver. 4.0 | Ver. 4.1 |
|-------------------------------------|---|---|
| Installation method | CX-Process Tool could be installed as a single entity only. | CX-Process Tool can be installed from the CX-One FA Integrated Tool Package as one function. If the CX-Process Tool is installed from the CX-One, a dialog box to select the communications driver will not be displayed when the CX-Process is started and the CX-Server will be used automatically as the communications driver. |
| Startup method | From the Start Menu only | Startup can be performed by right-clicking on any of the following Loop Controllers under the I/O Table Window of CX-Programmer that was installed from the CX-One, and selecting Start Special Application . <ul style="list-style-type: none"> • CS1W-LCB01 (Loop Control Board) • CS1W-LCB05 (Loop Control Board) • CS1D-LCB05D (Loop Control Board) • CS1W-LC001 (Loop Control Unit) • CJ1W-LCB01 (Loop Controller Element built into CPU Unit) • CJ1W-LCB03 (Loop Controller Element built into CPU Unit) <p>Note If <i>Start with Settings Inherited</i> is selected, CX-Server will be used automatically as the communications driver. The node's Function Block File will also be automatically created.</p> |
| Folder for creating/saving projects | Fixed location under data folder in the installation folder | The user can specify the folder for creating/saving projects. Select File – New from the menu bar and specify the destination in the Browse for Folder Dialog Box. |

1-4-10 Version 5.0

The improvements made from version 4.1 to version 5.0 of the CX-Process Tool are listed in the following table.

| Item | | Ver. 4.1 | Ver. 5.0 (See note.) |
|---|------------------------------------|--|--|
| Support for LCB01/05 and supports for Loop-control CPU Units (CJ1G-CPU□□P) Ver. 3.0 | | Only Ver. 2.0 or earlier were supported. | The following functions are supported for LCB01/05 and supports for Loop-control CPU Units (CJ1G-CPU□□P) Ver. 3.0: <ul style="list-style-type: none"> • Switch Instrument (Block Model 225), AI 2-point Terminal (Block Model 571), and AI 16-point Terminal (Block Model 582) • Switching the adjustment operation direction for Basic PID (Block Model 011) and Advanced PID (Block Model 012) • Switching RUN/STOP for Basic PID (Block Model 011) and Advanced PID (Block Model 012) • Tight shunt function and analog output reversal function for analog output terminals. |
| Free positioning of block diagrams | | Not supported (positioning was possible only at fixed locations) | Positioning is possible anywhere in the block diagram. |
| Increase in the number of blocks that can be registered in function block groups | | Only 16 blocks could be registered in each function block group. | Up to 64 blocks can be registered in each function block group. |
| Transferring tag comment data to flash memory | | Not supported. (Transfer was possible to a Memory Card in the CPU Unit.) | The following data can be transferred to flash memory in the Loop Controller: block diagram data, tags, comments, annotations, etc. (Data cannot be transferred to a Memory Card for Loop Control Board version 3.0.) |
| Wireless debugging | | Not supported. | A fixed value can be input as a pseudo-input to adjustment block PVs in a new calibration mode. |
| User link tables | MV tight shut function | Not supported. | Tight shut outputs to I/O memory in the CPU Unit are supported. |
| | MV analog output reversal function | Not supported. | Reversing outputs to I/O memory in the CPU Unit are supported. |
| | Copying/pasting | Not supported. | Entries in user link tables can be copied and pasted. |
| | EM bank specification | Not supported. (Only the current bank could be used.) | EM0 to EMC can be specified. |
| | Pulse output | Not supported. | Pulse output writing (ON for one refresh cycle) is possible to I/O memory in the CPU Unit when a specified ITEM turns ON. |
| Table reference function for sequence tables | | Not supported. | Results of conditions set in other tables can be referenced from Sequence Table (Block Model 302) using TBL commands. |
| Step ladder timer instructions | | Not supported. | Timer commands (TIM) can be used in Step Ladder Program (Block Model 301) |

Note These functions are supported only for Loop Control Boards and Loop-control CPU Units with unit version 3.0 or later.

1-4-11 Version 5.1

CX-Process Tool version updated from 5.0 to 5.1. The improvements made from version 5.0 to version 5.1 of the CX-Process Tool are listed in the following table.

| Item | Ver. 5.0 | Ver. 5.1 |
|--|---------------|--|
| Function blocks for gradient temperature control (Gradient PV Mode Converter (Block Model 021), Gradient SP Mode Converter (Block Model 022), Gradient PID (Block Model 024), Gradient Precompensator (Block Model 023)) | Not supported | Supported. 10-point control/group for up to 4 groups (when a Loop Controller with gradient temperature control is used.) Note: For details on gradient temperature control, refer to the Loop Controller with Gradient Temperature Control Operation Manual (Cat. No. W460). |

1-4-12 Version 5.2

The improvements made from version 5.1 to version 5.2 of the CX-Process Tool are listed in the following table.

| Item | Previous (Version 5.1) | Updated (Version 5.2) |
|--|--|---|
| Support for LCB01/05 version 3.5 and CJ1G-CPU□□P Loop-control CPU Unit version 3.5 | Support was provided only up to version 3.0. | The following new blocks are supported: <ul style="list-style-type: none"> • Segment Program 3 (Block Model 158) • Isolated Ai4 Terminal (PH41U, Block Model 572) • Isolated Ai4 Terminal (AD04U, Block Model 573) • Ai4 Terminal (ADG41, Block Model 581) The following new functions are supported: <ul style="list-style-type: none"> • Search area number specifications for Segment Program 2 (Block Model 157) • Easy parameter setting for Segment Program 2 (Block Model 157) and Segment Program 3 (Block Model 158) |
| Engineering unit display | Analog values could be set only as percentages. | An ITEM can be displayed and set in engineering units, based on scaling information (CSV tag information) for individual function blocks. |
| Output window display | Data, such as verification results, was displayed in fixed dialog boxes. | Data, such as verification results, is displayed in special windows. The following functions are supported. <ul style="list-style-type: none"> • Jumping to the relevant location from the displayed results • Copying results to the clipboard |
| Improved sequence for creating new function block data | Only an empty project workspace was created. | When a new project is created, all operations from inserting the Loop Controller to displaying the block diagram are executed automatically. |
| Improved method for adding function blocks | Function blocks could be added from only from the menus. | Function blocks can be added from a function block toolbar in the block diagram display. |

1-5 Function Blocks/ITEMs Incompatible with Earlier Versions

1-5-1 Incompatibility with Versions Earlier than Version 1.20

The following function blocks can be used only when Loop Control Unit CS1W-LC001 Ver.1.20 and onwards and CX-Process Tool Ver.1.20 and onwards are used:

- The following function blocks can be registered on CX-Process Tool when Loop Control Unit Ver.1.0□ and CX-Process Tool Ver1.20 or onwards are used. If the data of these function blocks is downloaded to the Loop Control Unit by LCU element when these function blocks are registered on CX-Process Tool, however, an error occurs, and the download is canceled. (Other function blocks also are not downloaded.)
- The following function blocks cannot be registered on CX-Process Tool when Loop Control Unit Ver.1.20 and onwards and CX-Process Tool Ver.1.00 are used. For this reason, these function blocks cannot also be downloaded to the Loop Control Unit. If the following function blocks already exist on the Loop Control Unit and are uploaded to CX-Process Tool, only the following function blocks are not uploaded. (When a new upload is performed, these blocks become empty.)

2-position ON/OFF (Block Model 001), 3-position ON/OFF (Block Model 002), Blended PID (Block Model 013), 3-input Selector (Block Model 163), 3-output Selector (Block Model 164), Batch Data Collector (Block Model 174), DI Terminal from Expanded CPU Unit (Block Model 455), DO Terminal from Expanded CPU Unit (Block Model 456), AI Terminal from Expanded CPU Unit (Block Model 457), AO Terminal from Expanded CPU Unit (Block Model 458)

Note The version of the Loop Control Unit can be verified in the Monitor Run Status Screen (**Execution, Operation, Monitor run status**) on CX-Process Tool. When the above function blocks are used, check in the Check System Operation screen on CX-Process Tool beforehand that the content of ITEM 099 onwards in the System Common block (Block Model 000) is as follows:

| ITEM | Data name | Data |
|------|-----------------------------|-------|
| 099 | MPU/FROM version indication | V1.20 |

Version V1.20 and onwards must be indicated.

1-5-2 Incompatibility with Versions Earlier than Version 1.50

The following function blocks described in this manual can be used only when Loop Control Unit CS1W-LC001 Ver.1.50 and onwards and CX-Process Tool Ver.1.50 and onwards are used:

- The following function blocks can be registered on CX-Process Tool when versions of Loop Control Unit earlier than Ver.1.50 (Ver.1.0□ or Ver.1.20) and CX-Process Tool Ver1.50 or onwards are used. However, if the data of these function blocks is downloaded to the Loop Control Unit by LCU element (data for one Loop Control Unit) when these function blocks are registered on CX-Process Tool, an error occurs, and only those function blocks are not downloaded. (Other function blocks are downloaded successfully.)
- The following function blocks cannot be registered on CX-Process Tool when Loop Control Unit Ver.1.50 and onwards and versions of CX-Process Tool lower than Ver.1.50 (Ver.1.00 or Ver. 1.20) are used. For this reason, these function blocks cannot also be downloaded to the Loop Control Unit. If the following function blocks already exist on the Loop Control Unit and are

uploaded to CX-Process Tool, only the following function blocks are not uploaded. (When a new upload is performed, these blocks become empty.)

Segment Program 2 (Block Model 157), Accumulated Value Input Adder (Block Model 182), Accumulated Value Input Multiplier (Block Model 183), Constant Comparator (Block Model 202), Variable Comparator (Block Model 203), Clock Pulse (Block Model 207), ON/OFF Valve Manipulator (Block Model 221), Motor Manipulator (Block Model 222), Reversible Motor Manipulator (Block Model 223), Motor Opening Manipulator (Block Model 224)

Likewise, the following functions can be used only when Loop Control Unit CS1W-LC001 Ver.1.50 and onwards and CX-Process Tool Ver.1.50 and onwards are used:

- The following ITEMs can be set on CX-Process Tool when versions of Loop Control Unit earlier than Ver.1.50 (Ver.1.0□N or Ver.1.20) and CX-Process Tool Ver.1.50 or onwards are used. However, if the data of these ITEMs is downloaded to the Loop Control Unit when these ITEMs are set on CX-Process Tool, only those ITEMs are not downloaded. (Other ITEMs are downloaded successfully.)
- The following ITEMs cannot be set on CX-Process Tool when Loop Control Unit Ver.1.50 or onwards and versions of CX-Process Tool lower than Ver.1.50 (Ver.1.00 or Ver. 1.20) are used. For this reason, these ITEMs cannot also be downloaded to the Loop Control Unit. If a download in major item units (Loop Control Units) or a download in function blocks units including initial setting data is performed, the respective defaults are set to the following ITEMs on the Loop Control Unit. If the following ITEMs are already set on the Loop Control Unit and are uploaded to the CX-Process Tool, only the following ITEMs are not uploaded.

AT (auto-tuning) functions of Basic PID block (Block Model 011) and Advanced PID (Block Model 012), and wait function and additional steps (step numbers 8 to 15) of the Ramp Program block (Block Model 155)

- Note**
1. For details on which actual ITEM this restriction applies to, refer to the ITEM list for the relevant function block in the Function Block Reference Manual.
 2. The version of the Loop Control Unit can be verified in the Monitor Run Status Screen (**Execution, Operation, Monitor Run Status**) on CX-Process Tool.

When the above function blocks are used, check in the Check System Operation screen on CX-Process Tool beforehand that the content of ITEM 099 onwards in the System Common block (Block Model 000) is as follows:

| ITEM | Data name | Data |
|------|-----------------------------|-------|
| 099 | MPU/FROM version indication | V1.50 |

Version V1.50 and onwards must be indicated.

1-5-3 Incompatibility with Versions Earlier than Version 2.00

The following function blocks described in this manual can be used only when Loop Control Unit CS1W-LC001 Ver. 2.00 and onwards and CX-Process Tool Ver. 2.00 and onwards are used:

- The following function blocks can be registered on CX-Process Tool when versions of Loop Control Unit earlier than Ver. 2.00 (Ver. 1.0□, Ver. 1.20, or Ver. 1.50) and CX-Process Tool Ver 1.50 or onwards are used. However, if the data of these function blocks is downloaded to the Loop Control Unit in major item units (units of Loop Control Unit) when these function blocks are registered on

CX-Process Tool, an error occurs, and only those function blocks are not downloaded. (Other function blocks are downloaded successfully.)

- The following function blocks cannot be registered on CX-Process Tool when Loop Control Unit Ver. 2.00 and onwards and versions of CX-Process Tool lower than Ver. 2.00 (Ver. 1.0□ Ver. 1.20, or Ver. 1.50) are used. For this reason, these function blocks cannot also be downloaded to the Loop Control Unit. If the following function blocks already exist on the Loop Control Unit and are uploaded to CX-Process Tool, only the following function blocks are not uploaded. (When a new upload is performed, these blocks become empty.)

ES100X Controller Terminal (Block Model 045), 4-point Warning Indicator (Block Model 110), Arithmetic Operation (Block Model 126), Time Sequence Data Statistics (Block Model 153), Receive All Blocks (Block Model 461), Send All Blocks (Block Model 462)

Likewise, the following functions can be used only when Loop Control Unit CS1W-LC001 Ver. 2.00 and onwards and CX-Process Tool Ver. 2.00 and onwards are used:

- The following ITEMS can be set on CX-Process Tool when versions of Loop Control Unit earlier than Ver. 2.00 (Ver. 1.0□ Ver. 1.20, or Ver. 1.50) and CX-Process Tool Ver. 2.00 or onwards are used. However, if the data of these ITEMS is downloaded to the Loop Control Unit when these ITEMS are set on CX-Process Tool, only those ITEMS are not downloaded. (Other ITEMS are downloaded successfully.)
- The following ITEMS cannot be set on CX-Process Tool when Loop Control Unit Ver. 2.00 or onwards and versions of CX-Process Tool lower than Ver. 2.00 (Ver. 1.0□ Ver. 1.20, or Ver. 1.50) are used. For this reason, these ITEMS cannot also be downloaded to the Loop Control Unit. If a download in major item units (units of Loop Control Unit) or a download in function blocks units including initial setting data is performed, the respective defaults are set to the following ITEMS on the Loop Control Unit. If the following ITEMS are already set on the Loop Control Unit and are uploaded to the CX-Process Tool, only the following ITEMS are not uploaded.

MV Output Retrace Time for PV Error has been added to 2-position ON/OFF (Block Model 001), 3-position ON/OFF (Block Model 002), Basic PID (Block Model 011), and Advanced PID (Block Model 012).
 High MV Limit Arrival Output and Low MV Limit Arrival Output have been added to Basic PID (Block Model 011), Indication and Operation (Block Model 032), and Ratio Setting (Block Model 033).
 MV Error Input and MV Error Display have been added to Batch Flowrate Capture (Block Model 014), Indication and Operation (Block Model 032), and Ratio Setting (Block Model 033).
 PV Error Input and PV Error Display have been added to Indication and Setting (Block Model 031), Indication and Operation (Block Model 032), Ratio Setting (Block Model 033), and Indicator (Block Model 034).
 Inputs X1 to X8 have been added to Constant Comparator (Block Model 202).
 Inputs X1 to X8 and Comparison Input R1 to R8 have been added to Variable Comparator (Block Model 203).
 Contact Inputs S33 to S224 have been added to Internal Switch (Block Model 209).

- Note**
1. For details on which actual ITEM this restriction applies to, refer to the ITEM list for the relevant function block in the Function Block Reference Manual.
 2. The version of the Loop Control Unit can be verified in the Monitor run status screen ([Execute]–[Run]–[Monitor run status]) on CX-Process Tool. When the above function blocks are used, check in the Check System Op-

eration screen on CX-Process Tool beforehand that the content of ITEM 099 onwards in the System Common block (Block Model 000) is as follows:

| ITEM | Data name | Data |
|------|-----------------------------|-------|
| 099 | MPU/FROM version indication | V2.00 |

Version V2.00 and onwards must be indicated.

1-5-4 Incompatibility with Versions Earlier than Version 2.50

Function Blocks Incompatible with Earlier Versions

The following function blocks can be used only with version 2.50 or later versions of the CS1W-LC001 Loop Control Unit and version 2.50 or higher versions of the CX-Process Tool.

Fuzzy Logic (Block Model 016), Range Conversion (Block Model 127), Ramped Switch (Block Model 167), Level Check (Block Model 210), AI4 Terminals from DRT1-AD04 Unit (Block Model 588), and AO2 Terminals from DRT1-DA02 Unit (Block Model 589)

- If an earlier version of the Loop Control Unit is used with CX-Process Tool version 2.50 or higher, these function blocks can be registered but the data for the function blocks won't be downloaded to the Loop Control Unit when LCU element data is downloaded. (The supported function blocks will be downloaded normally.)
- If Loop Control Unit version 2.50 or later is used with a lower version of the CX-Process Tool, these function blocks cannot be registered in the CX-Process Tool, so they cannot be downloaded to the Loop Control Unit. If these function blocks have been downloaded to the Loop Control Unit already, the data for these function blocks won't be uploaded from the Loop Control Unit. The supported function blocks will be uploaded normally. (If **Upload New** is selected, the unsupported function blocks will be empty.)

ITEMs Incompatible with Earlier Versions

The following ITEMs can be used only with version 2.50 or later versions of the CS1W-LC001 Loop Control Unit and version 2.50 or higher versions of the CX-Process Tool.

- Block Registration Flag (ITEM039) and Toolbar Version (ITEM110) in System Common (Block Model 000)
- Warning Limit (ITEM020) in the following Blocks:
Basic PID (Block Model 011), Advanced PID (Block Model 012), 2-position ON/OFF (Block Model 001), 3-position ON/OFF (Block Model 002), Indication and Setting (Block Model 031), Indication and Operation (Block Model 032), Ratio Setting (Block Model 033), Indicator (Block Model 034), and 4-point Warning Indicator (Block Model 110)
- SP Rate-of-change Limit Time Unit (ITEM030) in Advanced PID (Block Model 012)
- The following ITEMs in Batch Flowrate Capture (Block Model 014): Local SP Setting, Upper 4 Digits (ITEM024), Remote SP Setting, Upper 4 Digits (ITEM028), Current SP, Upper 4 Digits (ITEM030), Preset Value (ITEM061), and Batch Accumulated Value, Upper 4 Digits (ITEM065)
- Time Units (ITEM013) in Rate-of-change Limiter (Speed Response) (Block Model 143)
- Reference Input Disable Switch (ITEM020) in Segment Program 2 (Block Model 157)
- Output Type (ITEM006) in Contact Distributor (Block Model 201)
- Individual I/O Range Settings in the following Blocks:
AI Terminal from CPU Unit (Block Model 453), AO Terminal from CPU Unit (Block Model 454), AI4 Terminal (Block Model 561), PI4 Terminal (Block Model 562), and AI8 Terminal (Block Model 564)
- Receive Stop Switch (ITEM225) in the following Blocks:
DI Terminal from Expanded CPU Unit (Block Model 455) and AI Terminal from Expanded CPU Unit (Block Model 457)
- Send Stop Switch (ITEM225) in the following Blocks:
DO Terminal from Expanded CPU Unit (Block Model 456) and AO Terminal from Expanded CPU Unit (Block Model 458)

- Note**
1. For details on which actual ITEM this restriction applies to, refer to the ITEM list for the relevant function block in the Function Block Reference Manual.
 2. The version of the Loop Control Unit can be verified in the Monitor Run Status Screen (**Execution, Operation, Monitor Run Status**) on CX-Process Tool.

When the above function blocks are used, check in the Check System Operation screen on CX-Process Tool beforehand that the content of ITEM 099 onwards in the System Common block (Block Model 000) is as follows:

| ITEM | Data name | Data |
|------|-----------------------------|-------|
| 099 | MPU/FROM version indication | V2.50 |

Version V2.50 and onwards must be indicated.

1-5-5 Incompatibility with Versions Earlier than Version 3.2

Function Blocks Incompatible with Earlier Versions

The following function blocks can be used only with LCB01/LCB05 version 1.5 or later, or LCB03, together with the CX-Process Tool version 3.20 or higher.

- Ai4 Terminal (PTS51), Ai8 Terminal (PTS55), Ai4 Terminal (PTS52), Ai8 Terminal (PTS56), Ai8 Terminal (PDC55), Ao2 Terminal (DA021), Ai4/Ao2 Terminal (MAD42)

- If an earlier version of the Loop Control Board is used with CX-Process Tool version 3.20 or higher, these function blocks can be registered but the data for the function blocks won't be downloaded to the Loop Control Unit when LCU element data is downloaded. (The supported function blocks will be downloaded normally.)
- If Loop Control Board version 1.20 or later is used with a lower version of the CX-Process Tool, these function blocks cannot be registered in the CX-Process Tool, so they cannot be downloaded to the Loop Control Unit. If these function blocks have been downloaded to the Loop Control Unit already, the data for these function blocks won't be uploaded from the Loop Control Unit. The supported function blocks will be uploaded normally. (If **Upload New** is selected, the unsupported function blocks will be empty.)

1-5-6 Incompatibility with Versions Earlier than Version 4.0

Function Blocks Incompatible with Earlier Versions

The following function blocks can be used only with LCB01/LCB05 version 2.0 or later, or LCB03, together with the CX-Process Tool version 4.0 or higher.

Ai4 Terminal (PTS51/52) (Block Model 590), Ao2 Terminal (DA021) (Block Model 591), Ai4/Ao2 Terminal (MAD42) (Block Model 592)

- If an earlier version of LCB□□ is used with a lower version of the CX-Process Tool, these function blocks cannot be registered in the CX-Process Tool, so they cannot be downloaded to the LCB□□.

1-5-7 Incompatibility with Versions Earlier than Version 5.0

Function Blocks Incompatible with Earlier Versions

The following function blocks can be used only with LCB03 and only if LCB03 is used together with CX-Process Tool version 5.1 or higher. If used with a lower version of the CX-Process Tool, the following function blocks cannot be registered and, therefore, cannot be downloaded to the Loop Control Board.

Gradient PV Mode Converter (Block Model 021), Gradient SP Mode Converter (Block Model 022), Gradient PID (Block Model 024), Gradient Precompensator (Block Model 023)

The following function blocks can be used only with LCB01/LCB05 version 3.0 or later, or LCB03 version 3.0 or later, together with the CX-Process Tool version 5.0 or higher.

- The following function blocks cannot be registered if LCB01/LCB05 version 3.0 or later, or LCB03 version 3.0 or later, is used together with a version of CX-Process Tool lower than version 5.0. For this reason, these function blocks cannot be downloaded to the Loop Controller

AI16 Terminal (AD161), AI2 Terminal (PTS15/16, PDC15), Switch Instrument (Block Model 225)

- The following settings cannot be used if LCB01/LCB05 version 3.0 or later, or LCB03 version 3.0 or later, is used together with a version of CX-Process Tool lower than version 5.0.

Switch action direction command (ITEM 053), RUN/STOP switch (ITEM 093), and MV at stop (ITEM 094) in Basic PID (Block Model 011) or Advanced PID (Block Model 012)

Note For details on which actual ITEM this restriction applies to, refer to the ITEM list for the relevant function block in the Function Block Reference Manual.

1-5-8 Incompatibility with Versions Earlier than Version 5.2

Function Blocks Incompatible with Earlier Versions

The following function blocks cannot be registered on the CX-Process Tool when LCB01/05 version 3.5 or later or LCB03 version 3.5 or later is used with

CX-Process Tool version 5.1 or earlier. Therefore they cannot be downloaded to the Loop Controller.

Isolated Ai4 Terminal (PH41U, Block Model 572), Isolated Ai4 Terminal (AD04U, Block Model 573), Ai4 Terminal (ADG41, Block Model 581), Segment Program 3 (Block Model 158)

Similarly, the following ITEMS can be used only when LCB01/05 version 3.5 or later, LCB03 version 3.5 or later, and CX-Process Tool version 5.2 or later are used.

Search Area Specification Wait (ITEM189), Search Area Number (ITEM194), and Reference Input Search Method (ITEM190) for Segment Program 2 search area specification

Note For details on particular ITEMS, refer to the *Function Block Reference Manual*.

1-6 Connecting to the PLC

Either one of the following communications drivers can be selected to support the connection with a PLC (Programmable Controller):

- FinsGateway
- CX-Server

Selection is also possible when CX-Process Tool is started from the Start Menu, or when **Start Only** is selected from the I/O Table Window using CX-Programmer that was installed from the CX-One only.

When using the CX-Process Tool installed from the CX-One, the default setting is to not display the dialog box for selecting the communications driver.

Note If *Start with Setting Inherited* is selected from the I/O Table Window using CX-Programmer that was installed from the CX-One, CX-Server will be used automatically as the communications driver.

1-6-1 Features of FinsGateway and CX-Server

The following table compares the special features of the communications drivers.

| Item | Communications driver | |
|--|---|---|
| | FinsGateway | CX-Server |
| Serial communications modes for serial connections | Host Link (SYSWAY-CV) | Host Link or Peripheral Bus |
| Network communications through a serial connection | Supported | Supported |
| Direct network connection | Supported | Supported |
| Node address setting range | 1 or higher (cannot be set to 0) | Must be set to 0 when the computer is connected directly to the PLC |
| Other features | <ul style="list-style-type: none"> • The same COM port can be used for simultaneous online connections with applications using FinsGateway (such as PLC Reporter and SYSMAC OPC Server). | <ul style="list-style-type: none"> • The same COM port can be used for simultaneous online connections with Tools such as CX-Programmer, CX-Protocol, and CX-Motion. • Supports high-speed Peripheral Bus communications. |

Note The PLC's node address must be set to 0 when using CX-Server and connecting directly to the PLC in a 1:1 or 1:N connection. (The 1:N connection is possible with Host Link communications only.) On the other hand, the node address cannot be set to 0 when connecting to the PLC through FinsGateway; the node address must be 1 or higher.

If CX-Server was selected as the communications driver and a Function Block

File (.ist) was created for node address 0 with filename “Node00” in that project, the project (multi-node file) cannot be opened if FinsGateway is selected later.

1-6-2 Selecting the Communications Driver

The following dialog box is displayed by default when the CX-Process Tool is started from the Start Menu if the CX-Process Tool was installed from the individual product CD-ROM.

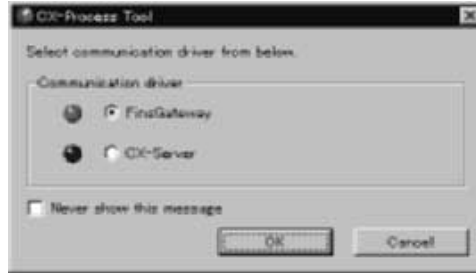

- Note**
1. This dialog box is not displayed by default if the CX-Process Tool was installed from the CX-One.
 2. The above dialog box will be displayed when the CX-Process Tool is started while **File – Show Drive Select Dialog – Display** is selected. It will not be displayed if **File – Show Drive Select Dialog – Hide** is selected. To change the communications driver, select **File – Show Drive Select Dialog – Display** and then start the CX-Process by selecting **Start Only** from the Start Menu or I/O tables. If the CX-Process was installed as part of the CX-One (not independently), the above dialog box will not be displayed (i.e., **File – Show Drive Select Dialog – Hide** will be selected) and the CX-Server will automatically be used as the communications driver. To switch to the FinsGateway, select **File – Show Drive Select Dialog – Display** and then select *FinsGateway* at startup.

Using FinsGateway

Select *FinsGateway* as the communications driver.

Using CX-Server

Select *CX-Server* as the communications driver.

1-6-3 Using FinsGateway

Regardless of the connection method, use FinsGateway (embedded) as the communications driver.

| Communications network | | FinsGateway communications driver | Contents |
|-------------------------|---------------------------------|--|--|
| Serial communications | Host Link Network (See note 1.) | Serial Unit Driver | Connecting to the PLC’s peripheral or RS-232C port via Host Link. |
| | Peripheral bus (See note 2.) | | |
| Controller Link Network | | CLK (PCI slot) Driver (Not supported by FinsGateway Version 2) | Connecting through the Controller Link Support Board to a PLC with a Controller Link Unit mounted. |
| | | Controller Link Driver | |
| Ethernet Network | | ETN_UNIT Driver | Connecting through the Ethernet Board to a PLC with an Ethernet Unit mounted. |

- Note**
1. Host Link communications use FINS commands enclosed in a header and terminator data (i.e., SYSMAC-WAY for FinsGateway). Host Link communications (SYSMAC WAY) is set for the PLC.
 2. FinsGateway Version 2003 only.

Connecting via Serial Communications

The personal computer uses the FinsGateway Serial Unit Driver to connect to the PLC’s peripheral or RS-232C port via Host Link communications.

Host Link (SYSMAC WAY)

Peripheral Bus

The personal computer uses the FinsGateway (Version 2003) Serial Unit Driver to connect to the PLC's peripheral or RS-232C port via the peripheral bus.

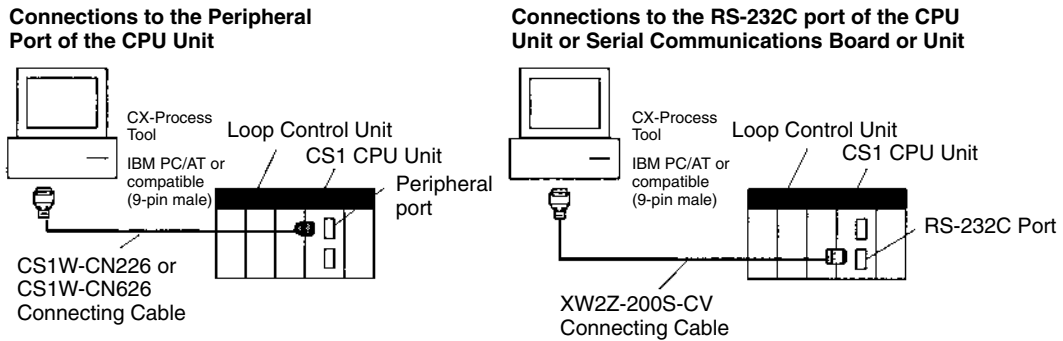

Note The FinsGateway Serial Unit Driver must be installed to enable connecting the PLC via Host Link communications.

Connecting through a Controller Link Support Board

The personal computer can be connected to the PLC through a Controller Link Network using the FinsGateway CLK (PCI slot) Driver or a FinsGateway version 2 or higher Controller Link Driver.

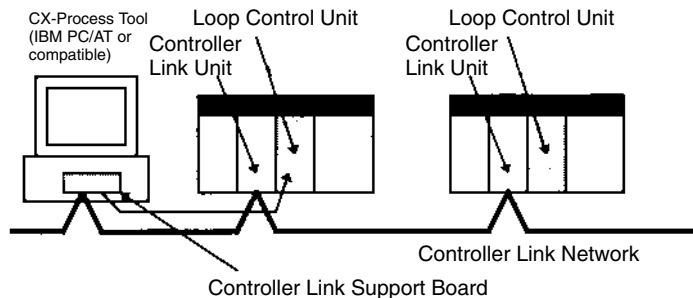

Note The Controller Link Driver (FinsGateway CLK (PCI slot) Driver or the FinsGateway version 2 or higher Controller Link Driver) must be installed in order to connect to the PLC via a Controller Link Network.

Controller Link Unit Models

| Controller Link Unit | PLC | Unit | Type | Transmission path |
|-----------------------------|-----------|--------------|---------|---------------------------|
| CS1W-CLK21-V1 CS1W-CLK23 | CS Series | CPU Bus Unit | Wired | Twisted-pair cable |
| CS1W-CLK12-V1 CS1W-CLK13 | | | Optical | H-PCF Optical fiber cable |
| CS1W-CLK52-V1 CS1W-CLK53 | | | Optical | GI Optical fiber cable |
| CJ1W-CLK21-V1 CJ1W-CLK23 | CJ Series | CPU Bus Unit | Wired | Twisted-pair cable |

Controller Link Support Boards

| Controller Link Support Board | Transmission medium | Computer | FinsGateway Driver |
|-------------------------------|--|------------------------------------|---|
| 3G8F7-CLK12-V1 3G8F7-CLK13 | Optical fiber cable (ring configuration) | IBM PC/AT or compatible (PCI slot) | CLK (PCI slot) Driver (FinsGateway Version 2 cannot be used.) |
| 3G8F7-CLK52-V1 3G8F7-CLK53 | | | |
| 3G8F7-CLK21-V1 3G8F7-CLK23 | Wire | | |
| 3G8F5-CLK11-V1 | Optical fiber cable | IBM PC/AT or compatible (ISA slot) | Controller Link Driver |
| 3G8F5-CLK21-V1 | Wire | | |

Connections via Ethernet

The personal computer can be connected to the PLC through an Ethernet Network using the FinsGateway ETN_UNIT Driver.

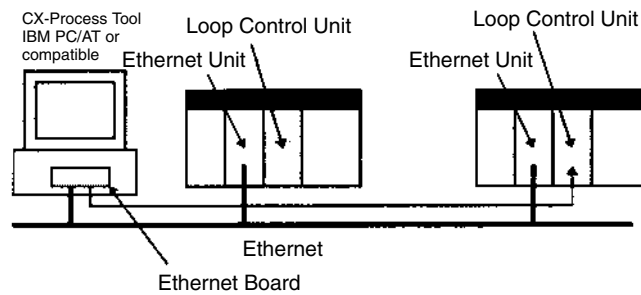

Note The FinsGateway ETN_UNIT Driver must be installed in order to connect to the PLC via an Ethernet Network.

Ethernet Unit Model

| Model | PLC | Unit | Ethernet |
|------------|-----------|--------------|------------|
| CS1W-ETN01 | CS Series | CPU Bus Unit | 10Base-5 |
| CS1W-ETN11 | | | 10Base-T |
| CS1W-ETN21 | | | 100Base-TX |
| CJ1W-ETN11 | CJ Series | CPU Bus Unit | 10Base-T |
| CJ1W-ETN21 | | | 100Base-TX |

Using CX-Server

The following two methods can be used to connect to the PLC.

| Communications network | Network type specified in dialog box | Usage | Cable connection |
|--------------------------|--------------------------------------|--|--|
| Peripheral Bus (Toolbus) | Select Toolbus . | Special high-speed communications protocol for Programming Devices | Connect to the PLC's peripheral or RS-232C port. |
| Host Link (SYSMAC WAY) | Select SYSMAC WAY . | Standard protocol for general-purpose host computers | |

The connections shown in the following diagram can be used with either Peripheral Bus or Host Link connections.

Connections to the Peripheral Port of the CPU Unit

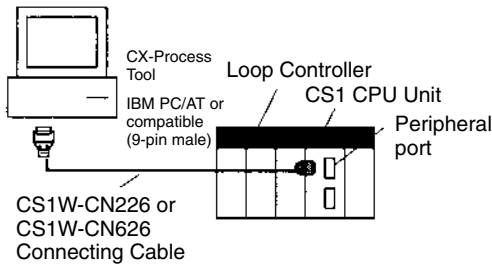

Connections to the RS-232C port of the CPU Unit or Serial Communications Board or Unit

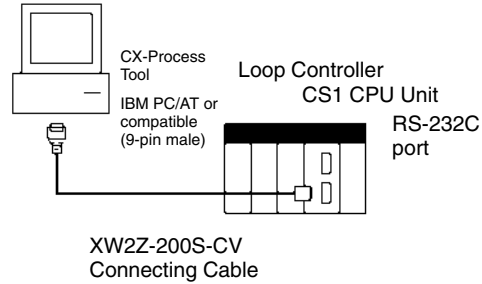

Note The Peripheral Bus connection cannot be used with a Serial Communications Board or Unit.

1-6-4 Connecting Cables

The following table lists the Connecting Cables that can be used for Peripheral Bus and Host Link connections. All of the cables connect to a male 9-pin D-Sub serial port on an IBM PC/AT or compatible computer.

| Unit | Port location | Serial Communications Mode | Model | Length | Remarks |
|-------------------------------------|--|--|--------------|--------|-----------------------|
| CPU Unit | Built-in peripheral port | Host Link (SYSMAC WAY) or Peripheral Bus (Toolbus) | CS1W-CN226 | 2.0 m | --- |
| | | | CS1W-CN626 | 6.0 m | |
| | Built-in RS-232C port Female 9-pin D-SUB | | XW2Z-200S-CV | 2 m | Anti-static connector |
| | | | XW2Z-500S-CV | 5 m | |
| Serial Communications Board or Unit | RS-232C port Male 9-pin D-SUB | Host Link (SYSMAC WAY) | XW2Z-200S-CV | 2 m | Anti-static connector |
| | | | XW2Z-500S-CV | 5 m | |

Note Touch a grounded metal to discharge all static electricity from your body before connecting any of the above cable connectors to the RS-232C port of the PLC. The XW2Z-□□□S-CV Cable uses the anti-static XM2S-0911-E Connector Hood. For safety sake, however, discharge all static electricity from your body before touching the connector.

The following components are used to connect RS-232C cable to the peripheral port. Connect to a male 9-pin D-Sub serial port on an IBM PC/AT or compatible computer.

| Unit | Port location | Serial Communications Mode | Model | Length | Remarks |
|----------|--------------------------|--|---------------------------|--------------------|---|
| CPU Unit | Built-in peripheral port | Host Link (SYSMAC WAY) or Peripheral Bus (Toolbus) | CS1W-CN118 + XW2Z-200S-CV | 0.1 m + (2 or 5 m) | The XW2Z-□□□S-CV is an anti-static connector. |
| | | | CS1W-CN118 + XW2Z-200S-V | | --- |

The following components are available for connecting the CQM1-CIF01 or CQM1-CIF02 Cable to the peripheral port. Connect to a male 9-pin D-Sub serial port on an IBM PC/AT or compatible computer.

| Unit | Port on Unit | Serial Communications Mode | Model | Length | Remarks |
|----------|--------------------------|----------------------------|-------------------------|---------------|---------|
| CPU Unit | Built-in peripheral port | Host Link (SYSMAC WAY) | CS1W-CN114 + CQM1-CIF02 | 0.5 m + 3.3 m | --- |

The following components are available for connecting the IBM PC/AT or compatible over RS-232C. Connect to a male 9-pin D-Sub serial port.

| Unit | Port on Unit | Serial Communications Mode | Model | Length | Remarks |
|-------------------------------------|---|----------------------------|-------------|--------|---------|
| CPU Unit | Built-in RS-232C port Female 9-pin D-SUB | Host Link (SYSMAC WAY) | XW2Z-200S-V | 2 m | --- |
| | | | XW2Z-500S-V | 5 m | |
| Serial Communications Board or Unit | RS-232C Port Female 9-pin D-SUB | | XW2Z-200S-V | 2 m | |
| | | | XW2Z-500S-V | 5 m | |

1-7 Basic Operating Procedures

The following steps are needed to use a Loop Controller.

Step: 1 Design

- 1, 2, 3...**
1. Prepare function drawings.
 2. Determine the PLC configuration.
 3. Select the function blocks.
 4. Determine the configuration of the function blocks.
 5. Determine the data to be monitored or operated in the CX-Process Monitor.
 6. Install the CX-Process Tool, the CX-Process Monitor, and the communications driver.

Step 2: Creating Function Blocks

Starting from the Start Menu or Selecting *Start Only* from the I/O Tables

- 1, 2, 3...**
1. Start the CX-Process Tool.
The following dialog box will be displayed by default when the CX-Process Tool is started.

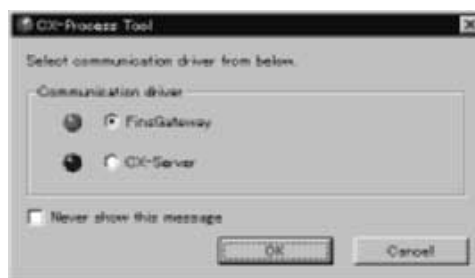

Select the communications driver to use (FinsGateway or CX-Server).

This dialog box will not be displayed when starting by selecting *Start Only* from the CX-Programmer's I/O tables. The CX-Server will automatically be selected as the communications driver.

- Note** (1) When using the CX-Process Monitor or CX-Process Monitor Plus, always set FinsGateway as the communications driver. CX-Server is not supported as the communications driver for the CX-Process Monitor or CX-Process Monitor Plus.

- (2) For details on starting the CX-Process Tool, refer to 2-1-9 Starting the CX-Process Tool.

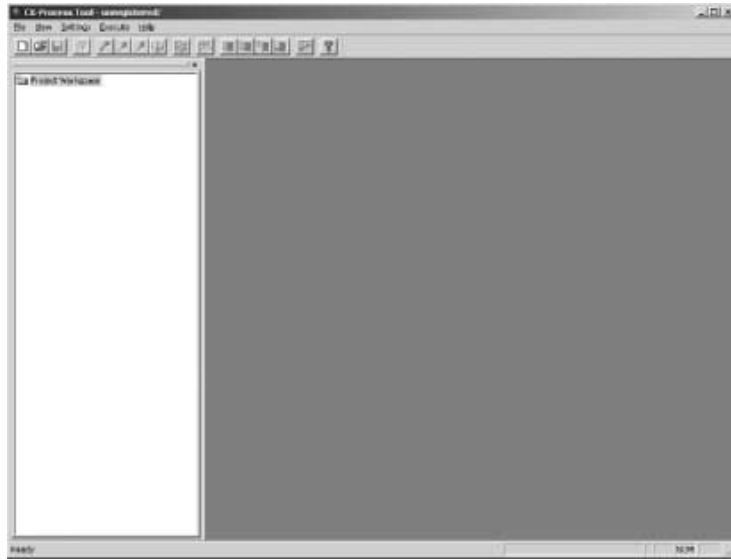

- 2. Create a new project in the Project Workspace.
- 3. Go to step 3, below, and set the System common block.

Starting by Selecting Start with Settings Inherited from the I/O Tables

- 1, 2, 3... 1. Right-click the Loop Control Board or Unit in the I/O Table Window, and select **Start Special Application - Start with Settings Inherited**.

Example: Right-click on the Loop Control Board (e.g., CS1W-LCB05).

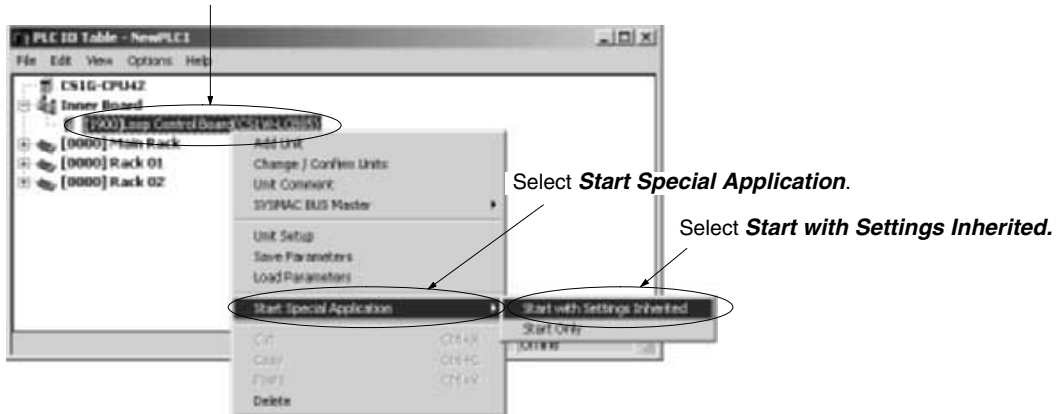

2. The CX-Process Tool will start and a new project will be created. The Number-Model setting (e.g., 00-LCB05) will be automatically selected based on the Loop Control Board/Unit model in the I/O tables.

The node is inserted automatically.

The Insert LCB/LCU Dialog Box will be displayed.

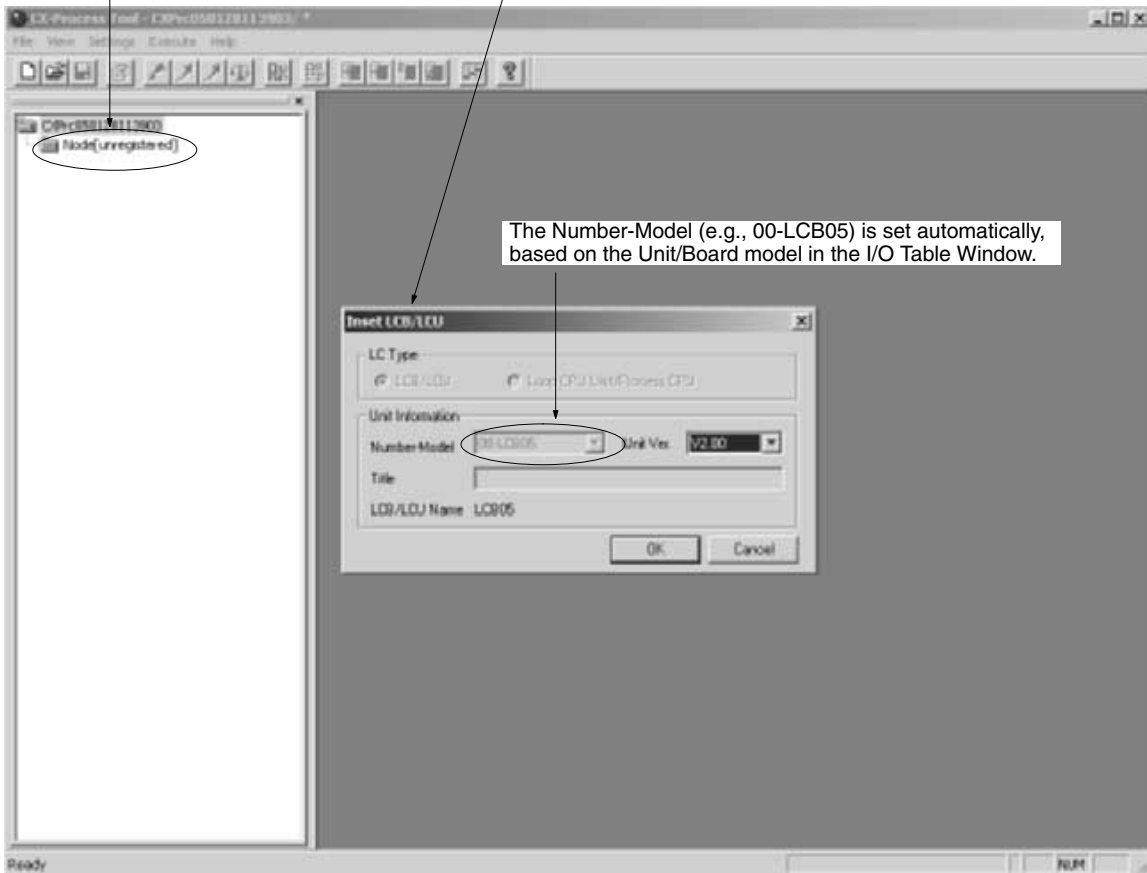

3. Set the System Common Block.
4. Register the function block.

- Note**
- (1) For details on setting the System Common Block, refer to *3-1-5 Making System Common Block Initial Settings*.
 - (2) For details on registering function blocks, refer to *3-1-6 Registering Function Blocks*.

- Set the software connections between function blocks with analog and accumulator signals (using **Edit – Block Diagram** from the Settings Menu).

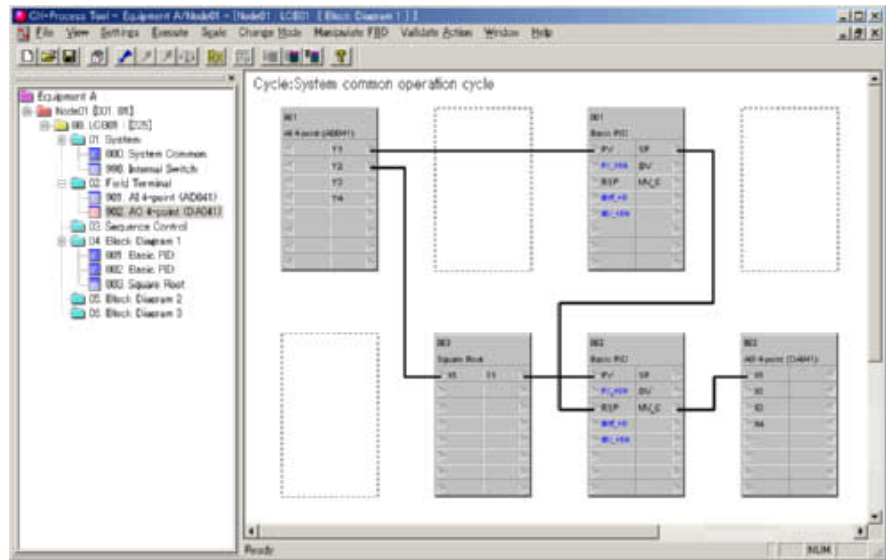

- Set the ITEMS in all function blocks (and set user link tables or create sequence tables or step ladder programs as needed).

- Note**
- User link tables are supported by LCB□□s only.
 - Sequence tables are supported by LCB05 and LCB05D (LCB elements 00-LCB05 and 00-LCB05D) only.

- Go to step 8 in one of the following sections.

| ITEM | Type | ITEM Use | Data | Data Name |
|------|------|------------------------|-----------|-------------------------------------|
| 001 | S | < Initial setting def. | | |
| 002 | S | COMMENT | Basic PID | Comment |
| 003 | S | MODEL | 001 | Model/Basic PID |
| 004 | S | MODEL/AD | 001 | Model/Basic PID (AD041) |
| 005 | S | SCAN_RATE | 3000 | Operation cycle |
| 006 | S | PV_AD | 901.021 | PV source destination |
| 012 | S | HS_SP | 1.00 | Hysteresis setting |
| 018 | S | PVE_AD | 000.000 | PV error source destination |
| 020 | S | ALM_LIM | 0 | Alarm limit |
| 021 | S | RSP_AD | 000.000 | RSP source |
| 024 | S | CAS_SET | 0 | Set Point setting mode (default) |
| 025 | S | SC | 0 | PV tracking at local (MAN) |
| 032 | S | SB | 0 | Bumpless processing |
| 043 | S | DV_SQ | 1 | Deviation alarm standby sequence |
| 051 | S | PID_RATE | 0 | Processing cycle of PID control |
| 052 | S | OPR_REV | 0 | Control action |
| 061 | S | ISE_AD | 000.000 | Out-of-range processing |
| 062 | S | IPV_ATM | 0 | Output saturation time for PV error |
| 068 | S | IPV_ICV | 0 | Inversion of host indicated PV |
| 069 | S | IPVE_AD | 000.000 | PV error source destination |
| 070 | S | < Operation data > | | |
| 008 | O | HH_SP | 115.00 | High/high alarm setting |
| 009 | O | H_SP | 100.00 | High alarm setting |
| 010 | O | L_SP | 6.00 | Low alarm setting |
| 011 | O | LL_SP | -15.00 | Low/low alarm setting |
| 017 | O | ACS | 0 | Alarm stop switch |
| 022 | O | SP_sel | 0.00 | Local Set Point setting |
| 026 | O | R/L_SP | 0 | Remote/Local switch |
| 035 | O | AT | 0 | AT command/AT Executing |
| 036 | O | CVCL_OUT | 25.00 | Limit cycle MV amplitude |
| 037 | O | CVCL_HE | 0.20 | Limit cycle hysteresis |
| 038 | O | AT_GAIN | 1.00 | AT calculation gain |
| 039 | O | AT_DEV | 10.00 | Judgment DEV for provisional AT |
| 040 | O | AT_TYP | 0 | AT type |
| 041 | O | DVA_SP | 115.00 | Deviation alarm setting |

- Note**
- For details on editing block diagrams, refer to 3-1-8 *Editing Block Diagrams*.
 - For details on editing function block ITEMS, refer to 3-1-9 *Editing Function Block ITEMS*.

Using CX-Process Monitor (Supported Only for Loop Control nits)

- Set the function block for data exchange with CX-Process Monitor, i.e., the Block Send Terminal to Computer Function Blocks.
- Create the monitor tag file (using **Tag Settings – Monitor Tag** from the Settings Menu).
- Create the monitor tag file (using **Create Tag File – Monitor Tag** from the Execution Menu).

Note Install the CX-Process Monitor on the same personal computer before creating monitor tag files.

Using CX-Process Monitor Plus

The procedure depends on whether a Loop Control Unit or Loop Control Board (LCB□□s) is being used.

Loop Control Units

8. Register and connect the function blocks to exchange data with the CX-Process Monitor Plus.

| Items to monitor | Registrations and connections | Loop Control Unit |
|---------------------|---|--|
| Function block data | Only register the function blocks. | Send All Blocks block (Block Model 462) and Receive All Blocks block (Block Model 461) |
| Contact signals | Register and connect the function blocks. | Contact Distributor (Block Model 201) or Internal Switch (Block Model 209) |
| Analog signals | Register and connect the function blocks. | Input Selector block (Block Model 162) and Constant Generator block (Block Model 166) |

9. Set CSV tags and tags for the CX-Process Monitor Plus as follows:

- Function block data: Set CSV tags.
- Individual contact signals: Set CX-Process Monitor Plus tags for the contacts in the Internal Switch block (Block Model 209).
- Individual analog signals from LCU element to computer: Set CX-Process Monitor Plus tags for the analog signals in the Input Selection block (Block Model 162).
- Individual analog signals from computer to LCU element: Set CX-Process Monitor Plus tags for the analog signals in the Constant Generator block (Block Model 166).

10. Generate the CX-Process Monitor Plus tag file (***Execute – Create Tag File – Monitor Plus Tag***).

11. Start the CX-Process Monitor Plus and click the **Start** Button.

LCB□□s

8. Register and connect the function blocks to exchange data with the CX-Process Monitor Plus.

| Items to monitor | Registrations and connections | LCB□□s |
|---------------------|---|---|
| Function block data | Only register the function blocks. | HMI settings in the System Common block (Block Mode 000) |
| Contact signals | Register and connect the function blocks. | Contact Distributor (Block Model 201) or Internal Switch (Block Model 209) |
| Analog signals | Register and connect the function blocks. | Input Selector block (Block Model 162) and Constant Generator block (Block Model 166) |

9. Set CSV tags and tags for the CX-Process Monitor Plus as follows:

- Function block data: Set CSV tags.
- Individual contact signals: Set CX-Process Monitor Plus tags for the contacts in the Internal Switch block (Block Model 209).
- Individual analog signals from LCB element to computer: Set CX-Process Monitor Plus tags for the analog signals in the Input Selection block (Block Model 162).
- Individual analog signals from computer to LCB element: Set CX-Process Monitor Plus tags for the analog signals in the Constant Generator block (Block Model 166).

10. Generate the CX-Process Monitor Plus tag file (***Execute – Create Tag File – Monitor Plus Tag***).

11. Start the CX-Process Monitor Plus and click the **Start** Button.

Note For all Loop Controllers, the following function blocks must be created and connected separately to enable monitoring and setting individual contact signals and individual analog signals (i.e., other than function block data).

- To monitor and set individual contact signals, contact signals must be input/output using the Contact Distributor block (Block Model 201) and Internal Switch block (Block Model 209).
- To monitor individual analog signals, analog signals must be output from the Input Selection block (Block Model 162).
- To set individual analog signals, analog signals must be input to the Constant Generator block (Block Model 166).

- Note** (1) For details on the CX-Process Monitor, refer to 3-2 *Using the CX-Process Monitor*.
- (2) For details on the CX-Process Monitor, refer to 3-3 *Using the CX-Process Monitor Plus*.

Using SCADA Software

8. Set the Send All Blocks or Receive All Blocks Function Blocks (and if necessary, Expanded CPU Unit Terminal and CPU Unit Terminal Function Blocks). (Required only for Loop Control Unit; not required for LCB□□.)
9. Set the CSV tags (using **Tag Settings – CSV Tag** from the Settings Menu). If using CX-Process Tool version 3.1 or higher, automatically register the CSV tags and then edit the CSV tag settings file in Excel.
10. Output the CSV tag file (using **Create Tag File – CSV Tags** from the Execution Menu).
11. Import the CSV tag file for SCADA software into the SYSMAC OPC Server.
12. Manually export the RS View tag file from the SYSMAC OPC Server.
13. Import the RS View tag file to the RS View 32 using the import utility in the RS View 32.

Using the RS View 32

8. For a Loop Control Unit, register Send All Blocks and Receive All Blocks blocks. (This is not necessary for LCB□□.)
9. Set the CSV tags (using **Tag Settings – CSV Tag** from the Setting Menu).
10. Output the CSV tag file (using **Create Tag File – RS View Tags** from the Execution Menu).
11. Import the RS View tag file directly to the RS View 32 using the import utility in the RS View 32.

Note For details on SCADA Software and RS View, refer to 3-4 *Preparations for Using SCADA Software*.

Step 3: Save the Project Workspace Data

Using **Save** from the File Menu

Step 4: Unit Setup

- 1, 2, 3... 1. Mount the Units and wire the Analog I/O Units. The Loop Controller does not need any wiring.
2. Set each Unit to a unique unit number.
3. Connect the Programming Device.

Note With CS1D CPU Units (using the CS1D-CPU□□P), connect to the active CPU Unit.

4. Turn ON the PLC.

5. Create the I/O tables with the Programming Device.
6. Set the PLC Setup serial communications port settings with the Programming Device if needed.
7. Set the allocated DM area of the Analog I/O Unit with the Programming Device.

Step 5: Transfer Created Function Block Data to Loop Controller

1, 2, 3...

The following steps are used when connected to the PLC via Host Link communications.

1. Turn OFF the PLC.
2. Set the DIP switch on the front panel of the CPU Unit. Set pin 4 to ON to use the peripheral port and set pin 5 to OFF to use the RS-232C port. With a CS1D Duplex System, set the DIP switch on the front panel of the Duplex Unit. Turn ON PRPHL to use the peripheral port or turn ON COMM to use the RS-232C port.
3. Connect the CPU Unit to the personal computer (CX-Process Tool).
4. Turn ON the PLC.
5. If FinsGateway is being used:
With the CX-Process Tool, set the network address to between 0 and 127, the node address to 01, and the unit address to the unit number plus 10 hexadecimal (input in decimal) (using **Network Settings** from the Settings Menu). (See *section 4-2-2*.)
6. If FinsGateway is being used:
Connect the CX-Process Tool via Host Link communications (using **Activate Serial Port Driver** from the File Menu). (See *section 4-2-2*.)
7. Download the function block data from the CX-Process Tool (using **Transfer to LC – Selected** from the Execution Menu). (See *section 4-3-1*.)
8. Start operation from the CX-Process Tool (using **Operation – Run/Stop Command** from the Execution Menu) or turn the PLC OFF and ON. (See *section 4-4*.)

Note Check the following items before operating the Loop Controller.

- a) Make sure the Analog I/O Units used with the Loop Control Unit/Board are properly mounted.
- b) Make sure the unit numbers on the front panel of the Analog I/O Units coincide with the unit numbers set in the Field Terminal Function Blocks. Data for another Special I/O Unit will be read and written if an incorrect unit number is used.
- c) Make sure the initial settings in the System Common Block in the Loop Controller are correct. Check that the DM Area words for the Node Terminal Function Block in the CPU Unit of the Loop Controller will not be used for any other purpose.
- d) When writing data to the I/O memory in the CPU Unit with function blocks (e.g., using Send All Blocks, Expanded DO/AO Terminal to CPU Unit, or DO/AO Terminal to CPU Unit), be sure that the words written to in the I/O memory are not being used for any other purpose. If I/O memory words are allocated to more than one purpose, the PLC system may act unexpectedly and cause injury.
9. Check the indicators on the front of the from panel of the Loop Controller: On the Loop Control Unit, the RUN indicator should be lit and the ERC indicator not lit. On the LCB□□, the EXEC indicator should be lit.

Note With the CS1D-CPU□□P, approximately 2 minutes is required after power is turned ON for duplex initialization before the standby Loop Controller will start operation. The EXEC indicator and the DPL STA-

TUS indicator on the Duplex Unit will flash for 40 seconds before lighting.

Step 6: Trial Operation

- 1, 2, 3... 1. Start operation from the CX-Process Tool (using **Operation – Run/Stop Command** from the Execution Menu) or turn the PLC OFF and ON. (See [section 4-4.](#))



2. Monitor status with the CX-Process Tool (using **Operation – Monitor Run Status** from the Execution Menu) and check the load rate, for example. (See [section 4-5.](#))

| ITEM | Data Name | Data | Run |
|------|----------------------------------|-------|-------|
| 003 | Execution error display | 0 | |
| 015 | Stopped | 1 | |
| 016 | Hot start | 0 | |
| 017 | Cold start | 0 | |
| 041 | Self unit address | 16 | |
| 042 | LCU number | 0 | |
| 043 | Start address of Data Memory (D) | 1602B | |
| 051 | Processing time load rate | 0.01 | |
| 052 | Max. processing time load rate i | 0.02 | Reset |
| 053 | Operation Cycle Automatic Switch | 0 | Reset |
| 054 | Processing time load rate | 0.00 | |
| 055 | Max. control load rate indicatio | 0.10 | Reset |
| 056 | Operation Cycle Automatic Switch | 0 | Reset |
| 057 | Processing time load rate | 0.05 | |
| 058 | Max. control load rate indicatio | 0.05 | Reset |

3. Check the connections with the CX-Process Tool (using **Start** from the Validate Action Menu). (See [section 4-6-3.](#))

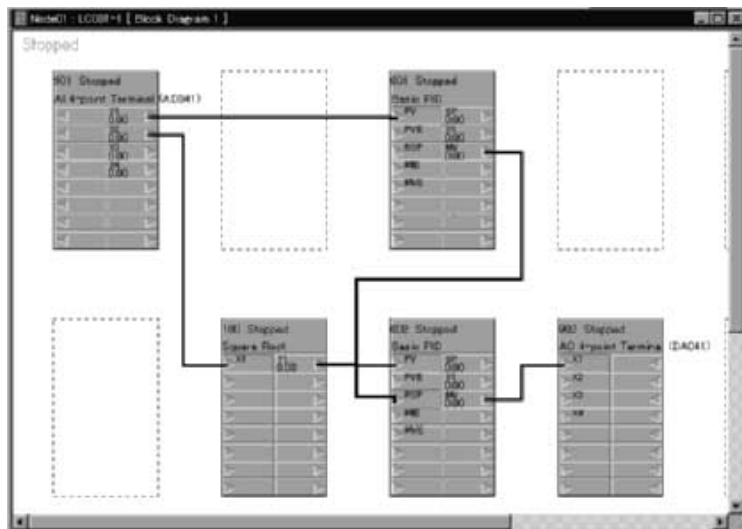

4. Tune parameters such as PID constants and make SP settings with the CX-Process Tool.

Step 7: Actual Operation

- 1, 2, 3...
1. Make any necessary settings and adjustments such as PID tuning with the CX-Process Tool, SCADA software, the CX-Process Monitor, or the CX-Process Monitor Plus.
 2. Monitor the PV and all alarms from SCADA software, the CX-Process Monitor, or the CX-Process Monitor Plus.

Note The CX-Process Monitor can be used for the Loop Control Units only. It cannot be used for the LCB□□s.

1-8 Operations

1-8-1 Creating Function Blocks

| Item | | | Menu item | Section |
|--|--|---|---|---------|
| Creating a new Project Workspace | | | New from the File Menu | 3-1-3 |
| Registering function blocks | | | <ol style="list-style-type: none"> 1. Select the function block group folder. 2. Select Insert – Insert Function Block from the Settings Menu, or right-click on the block diagram and select Register – Field Terminal/Sequence Control/Control Block. | 3-1-6 |
| Creating software connection between function blocks | | | <ol style="list-style-type: none"> 1. Select the folder for block diagram 1. 2. Select Edit – Block Diagram from the Settings Menu. 3. Select the function block to be pasted. 4. Click the right mouse button at the pasting position. Select Paste Function Block from the pop-up menu. 5. Select the block and change the position. 6. Click the start point of the connection and double-click the end point. | 3-1-8 |
| Settings ITEMS | | | <ol style="list-style-type: none"> 1. Double-click the function block registered on the Project Workspace Screen. 2. Double-click each ITEM. 3. Set the data in the Setting Dialog Box. | 3-1-9 |
| Registering elements in the user link table | Registering from the User Link Table Editing Screen | Registering elements individually | <ol style="list-style-type: none"> 1. Select Edit – User Link Table from the Settings Menu. 2. Right-click and select Register. | 3-5-2 |
| | | Registering elements in groups with same tag name and serial numbers (CX-Process Tool Ver. 3.2 or higher) | <ol style="list-style-type: none"> 1. Select Edit – User Link Table from the Settings Menu. 2. Right-click and select Block Set. | |
| | Creating software links by pasting user link tables in a block diagram | | <ol style="list-style-type: none"> 1. Right-click and select Register – User Link Table – Link input (Read from CPU Memory) or select Register – User Link Table – Link output (Write to CPU Memory) from the pop-up menu. 2. Right-click and select Register – User Link Table – Register Block Cell and then select a tag or input a new tag. 3. Software link. | 3-5-2 |

| Item | Menu item | Section |
|---|--|---------|
| Attaching user-defined comments (annotations) to function blocks and step ladder diagrams, displaying/printing comments | In the Function Block Connection Diagram, click the right mouse button to display the pop-up menu and select Annotations/Insert . Click the Annotation icon in Ladder Diagram Edit Mode. | 3-7-1 |
| Settings tags for CX-Process Monitor (Loop Control Unit only) | <ol style="list-style-type: none"> <li data-bbox="711 321 1318 428">1. Select the Send Terminal to Computer folder (block models between 401 and 404) or the Send Terminal to All Nodes (block models between 407 and 410). <li data-bbox="711 436 1318 489">2. Select Tag Settings – Monitor Tags from the Settings Menu. | 3-2-1 |
| Compiling tags for Monitor Software (Loop Control Unit only) | <ol style="list-style-type: none"> <li data-bbox="711 510 1318 562">1. Select Create Tag File – Monitor Tags from the Execution Menu. <li data-bbox="711 571 1318 602">2. Click the Start Button | 3-2-1 |
| Checking tags for Monitor Software settings (Loop Control Unit only) | <ol style="list-style-type: none"> <li data-bbox="711 617 1318 669">1. Select Show Tag List – Monitor Tag from the Execution Menu. | 3-2-2 |
| Settings tags for CX-Process Monitor Plus (CX-Process Tool Ver. 3.2 or higher) | <ol style="list-style-type: none"> <li data-bbox="711 690 1318 921">1. Select the function blocks and select Tag Settings – CSV Tags from the Setting Menu, or select function blocks for data exchange with the CX-Process Monitor Plus and select Tag Settings – Monitor Plus Tags from the Setting Menu. or Select the option to automatically register CSV tags when registering function blocks and edit the CSV tag file in Excel or other editor. | 3-3 |
| Compiling tags for CX-Process Monitor Plus (CX-Process Tool Ver. 3.2 or higher) | <ol style="list-style-type: none"> <li data-bbox="711 942 1318 995">1. Select Create Tag File – Monitor Plus Tag from the Execution Menu. <li data-bbox="711 1003 1318 1056">2. Click the Start Button on the main window of the CX-Process Monitor Plus. | 3-3 |
| Checking tags for CX-Process Monitor Plus settings (CX-Process Tool Ver. 3.2 or higher) | <ol style="list-style-type: none"> <li data-bbox="711 1079 1318 1131">1. Select Show Tag List – Monitor Plus Tag from the Execution Menu. | 3-3 |
| Creating (compiling) the CSV tag file for SCADA software | <ol style="list-style-type: none"> <li data-bbox="711 1173 1318 1362">1. Select the function block and select Tag Settings – CSV Tags from the Settings Menu to set the CSV tags. or Select the option to automatically register CSV tags when registering function blocks and edit the CSV tag file in Excel or other editor. <li data-bbox="711 1371 1318 1423">2. Compile the CSV tag file by selecting Create Tag File – CSV Tags from the Execution Menu. | 3-4-1 |
| Creating (compiling) an RS View tag file (.csv) | <ol style="list-style-type: none"> <li data-bbox="711 1446 1318 1635">1. Select the function block and select Tag Settings – CSV Tags from the Settings Menu to set the CSV tags. or Select the option to automatically register CSV tags when registering function blocks and edit the CSV tag file in Excel or other editor. <li data-bbox="711 1644 1318 1717">2. Compile the RS View tag file by selecting Create Tag File – RS View Tags from the Execution Menu. | 3-4-1 |
| Creating sequence tables (LCB05/05D only) | <ol style="list-style-type: none"> <li data-bbox="711 1740 1318 1772">1. Select the sequence table block. <li data-bbox="711 1780 1318 1833">2. Select Edit – Sequence Table from the Settings Menu. <li data-bbox="711 1841 1318 1894">3. Right-click on the sequence table and select Edit Mode – Enable. <li data-bbox="711 1902 1318 1950">4. Double-click the sequence table and input the data into the Signal Dialog Box. | 3-8-1 |

| Item | Menu item | Section |
|---|---|---------|
| Inputting step ladder programs as ladder diagrams | <ol style="list-style-type: none"> 1. Select the Step Ladder Program Block. 2. Select Edit – Ladder Program from the Settings Menu. 3. Select the icon and move it onto the ladder diagram and click the left mouse button. 4. Double-click the left mouse button on the ladder symbol. Input the data into the Data Setting Dialog Box. | 3-7-1 |
| Inputting step ladder programs in mnemonics | <ol style="list-style-type: none"> 1. Select the Step Ladder Program Block. 2. Select Edit – Ladder Program from the Settings Menu. 3. Select Mnemonics from the Manipulate Ladder Menu. 4. Click the Insert Row Button. 5. Input the instructions. | 3-7-2 |
| Printing function blocks, block diagrams, etc. | <ol style="list-style-type: none"> 1. Select Print from the File Menu, then select each data type. | 3-11 |

1-8-2 Online Operations

| Item | Menu item | Section |
|---|---|---------|
| Connecting via serial communications | <ol style="list-style-type: none"> 1. Activate and select the folder of the function block file. 2. Select Network Settings from the Settings Menu. 3. Input the network address. 4. Set the node address to 01. 5. Select the LCU/LCB element (by default set to LC001-1). 6. Select Network Settings from the Settings Menu. 7. Input the unit address. 8. Select Activate Serial Port Driver from the File Menu. 9. Click the OK Button. | 4-2-2 |
| Downloading function block data | <ol style="list-style-type: none"> 1. Activate the folder of the function block file and select the LCU/LCB element (default: LC001-1). 2. Select Transfer to LC – Selected from the Execution Menu. When the version is different from the Loop Controller element version, a warning dialog will be displayed. Click the OK Button and continue. 3. Click the OK Button. 4. If a step ladder program is included, click the OK Button for Convert Ladder To Mnemonics per LCU/LCB element. 5. Click the OK Button. 6. Set the objective item and start downloading the data. | 4-3-1 |
| Downloading each ITEM's data (Transferring to LC) | <ol style="list-style-type: none"> 1. Select Monitor/ITEM List from the Execution Menu to display the ITEM list, or double-click the function block registered on the Project Workspace Screen. 2. Double-click each ITEM. 3. Set the desired value and click the Transfer to LC Button. | 4-3-1 |

| Item | | Menu item | Section |
|--|---|--|---------|
| Uploading function block data (Transferring from LC) | | <ol style="list-style-type: none"> 1. Activate the folder of the function block file and select the LCU/LCB element (default: LC001-1). 2. Select Transfer from LC – New or Transfer from LC – Previous from the Execution Menu. 3. Click the OK Button or Start Button. 4. Check and click the OK Button. 5. Click the Start Button or OK Button. | 4-3-2 |
| Comparing function block file | With another function block file | <ol style="list-style-type: none"> 1. Activate and select the folder of the function block file. 2. Select Compare from the Execution Menu. 3. Select the function block file and select the level. 4. Select Compare. | 4-3-3 |
| | With function block data in a Loop Controller | <ol style="list-style-type: none"> 1. Activate the folder of the function block file and select the LCU/LCB element (default: LC001-1) or function block. 2. Select Compare from the Execution Menu. 3. Select the function block file and select the level. 4. Select Compare. | 4-3-3 |
| Starting a Loop Controller | | <ol style="list-style-type: none"> 1. Activate the folder of the function block file and select the LCU/LCB element (default: LC001-1). 2. Select Operation – Run/Stop Command from the Execute Menu. 3. Select HOT START or COLD START. 4. Select Execute. | 4-4 |
| Checking system operation of Loop Controller | Load rate check | <ol style="list-style-type: none"> 1. Activate the folder of the function block file and select the LCU/LCB element (default: LC001-1). 2. Select Operation – Monitor Run Status from the Execute Menu. | 4-5 |
| | Block address with execution error | | |
| Wireless Debug | | Select the function block that performs the pseudo-input from the block diagram and then select Wireless Debug from the right-click menu. | 4-6-4 |

SECTION 2

Preparations to Create Function Blocks

This section describes installing the CX-Process and provides an overview of the user interface.

| | | |
|-------|--|----|
| 2-1 | Installing and Uninstalling the Software | 50 |
| 2-1-1 | Software That Must Be Installed | 50 |
| 2-1-2 | Preparations for Installation | 51 |
| 2-1-3 | Precautions for Installation | 52 |
| 2-1-4 | Installing the CX-Process the CX-Server | 52 |
| 2-1-5 | Installing FinsGateway | 56 |
| 2-1-6 | Installing FinsGateway Embedded Version | 58 |
| 2-1-7 | Uninstalling the CX-Process Tool | 65 |
| 2-1-8 | Uninstalling the CX-Server | 66 |
| 2-1-9 | Starting the CX-Process Tool | 68 |
| 2-2 | Overview of User Interface | 69 |
| 2-2-1 | Project Workspace Tree | 71 |
| 2-2-2 | Output Window | 71 |
| 2-2-3 | Menus | 73 |

2-1 Installing and Uninstalling the Software

2-1-1 Software That Must Be Installed

The following software must be installed on the same computer to use the CX-Process Tool.

- 1, 2, 3...
1. CX-Process Tool
 2. CX-Server (the communications driver) or FinsGateway Embedded Version 3 or higher

Types of CX-Programmer

The CX-Process Tool is available both on an independent CD-ROM and on the CX-One FA Integrated Tool Package. The contents of the CX-Process Tool are the same in either case.

The installation procedure for the independent CD-ROM is provided here. Refer to the *CX-One Ver. 2.0 Setup Manual* (W463, provided with the CX-One) for the installation procedure for the CX-One.

| Cat. No. | Model | Manual name | Contents |
|----------|-------------------------------|---------------------------------|--|
| W463 | CXONE-AL□□C-E V2/AL□□D-EV2 | CX-One Ver. 2.0 Setup Manual | An overview of the CX-One FA Integrated Tool Package and the CX-One installation procedure |

Selecting Communications Drivers

Select the communications driver to be installed (CX-Server or FinsGateway). The following table shows the selection criteria.

Yes: Supported

No: Not supported

• Communications Method

| Communications driver | Communications method | | |
|-----------------------|-----------------------|--------------------------------------|--|
| | Toolbus | Duplex Ethernet at personal computer | Simultaneous online (serial) connection with CX-Programmer |
| CX-Server | Yes | No | Yes |
| FinsGateway Ver. 3 | No | No | No |
| FinsGateway Ver. 2003 | Yes | Yes | No |

• Compatible Applications

| Communications driver | Application | | |
|-----------------------|--------------------|-------------------------|-------------------|
| | CX-Process Monitor | CX-Process Monitor Plus | SYSMAC OPC Server |
| CX-Server | No | No | No |
| FinsGateway Ver. 3 | Yes | Yes | Yes |
| FinsGateway Ver. 2003 | NO | Yes | Yes |

The CX-Process Tool Setup Disk contains each of the communications drivers. The following .exe files are required for setup.

• CX-Server (See note.)

<CD-ROM drive>:\CX-Process Tool\CX-Server\setup.exe

Note The CX-Server will be installed at the same time as the CX-Process Tool.

• FinsGateway Ver. 3

- <CD-ROM drive>:\Fgwv3\FGW3ee\Serial\disk1\SETUP.EXE
- <CD-ROM drive>:\Fgwv3\FGW3ee\ETN\disk1\SETUP.EXE
- <CD-ROM drive>:\Fgwv3\FGW3ee\CLK(PCI)\disk1\SETUP.EXE
- <CD-ROM drive>:\Fgwv3\FGW3ee\CLK\disk1\SETUP.EXE

- FinsGateway Ver. 2003

<CD-ROM drive>:\Fgw2003\Fgw2003\Disk Images\Embed\setup.exe

2-1-2 Preparations for Installation

Note If the CX-Process Tool was previously installed from the CX-One and it is necessary to update it from the individual CX-Process Tool CD-ROM, always uninstall the CX-Process Tool using the following CX-One uninstall procedure before installing it from its individual CD-ROM.

Uninstalling the Previous Version of CX-Process Tool

Always uninstall the previous version of the CX-Process Tool before installing the new version.

- 1, 2, 3... 1. Start **Add/Remove Programs** (or **Add/Remove Applications**) from the control panel.
2. Select **CX-Process Tool** from the dialog box.
3. Click the **Change/Remove** Button. The CX-Process Tool will be uninstalled.



Uninstalling the CX-Server PLC Tools

If CX-Server PLC Tools is installed, then uninstall it.

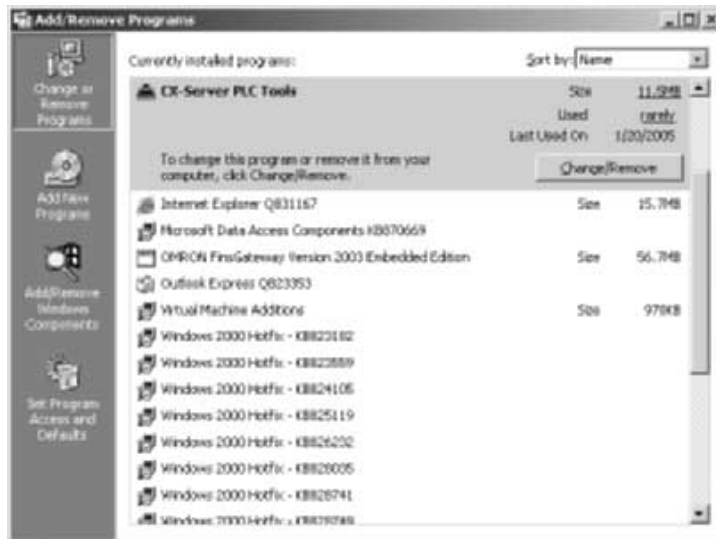

Note Do not uninstall the CX-Server Driver Management Tool or the CX-Server from the control panel. Doing so may make it impossible to use certain Units.

2-1-3 Precautions for Installation

- Close all programs running on Windows before starting the installation procedure.
- Do not stop the setup process in the middle. Copied files may remain in the installation folder.
- Do not turn OFF or reset the computer in the middle of the installation process. Computer data may become corrupted.
- On Windows NT 4.0, 2000, XP, or Vista, the administrator or a user with administrator rights must perform the installation. Other users will not have sufficient write permission and access errors will occur.

Note Internet Explorer version 5.0 or higher must be installed in advance to use the CX-Server Installer. Install Internet Explorer version 5.0 in advance if it is not already installed.

2-1-4 Installing the CX-Process the CX-Server

- 1, 2, 3...**
1. Place the CX-Process installation disk (CD-ROM) into the disk drive.
 2. Double-click the **Setup.exe** icon in the CX-Process Tool\Disk1 folder in the CD-ROM from Windows Explorer or other software.



A dialog box indicating that setup preparations are in progress will be displayed and then the InstallShield Wizard will be displayed. Click the **Next** Button.

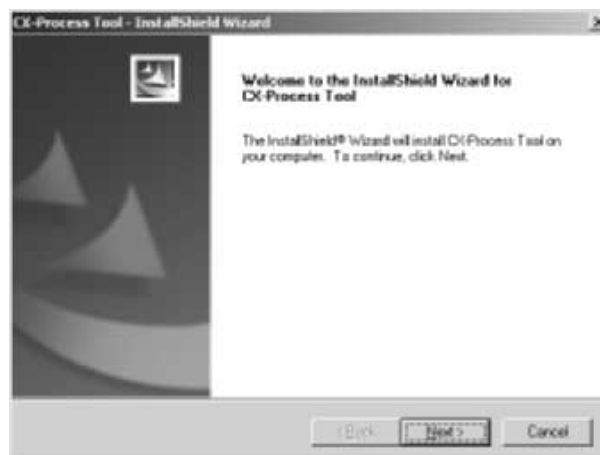

3. The *License Agreement* Dialog Box will be displayed.



Read the license agreement completely and if you accept all of the terms, select the *I accept the terms of the license agreement* Option and click the **Next** Button.

4. The *User Information* Dialog Box will be displayed.

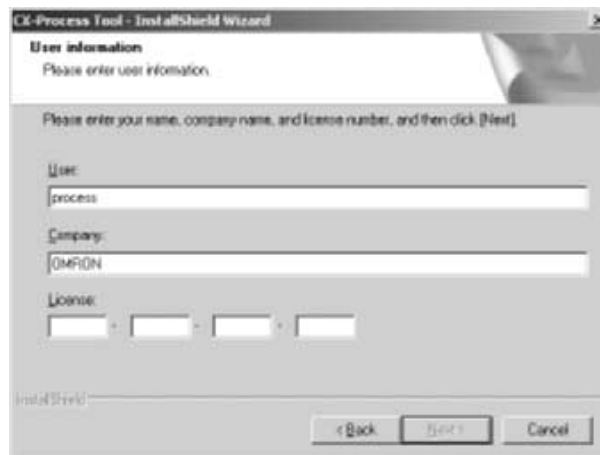

The default names registered in the computer will be entered for the user name and company name. Enter the license number and click the **Next** Button. The license number is given on the Software License/Registration Card provided with the product.

5. The *Choose Destination Location* Dialog Box will be displayed.



Select the destination location and click the **Next** Button. By default, the CX-Process Tool will be installed in the following location: C:\Program Files\OMRON\CX-One\CX-Process Tool\.

6. The *Setup Type* Dialog Box will be displayed.

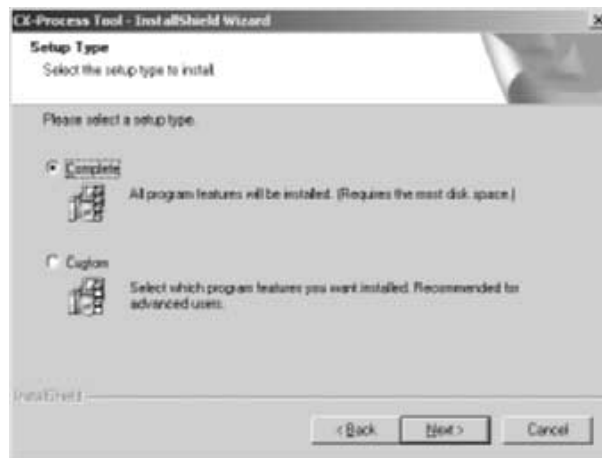

Select the *Complete* or *Custom* Option and click the **Next** Button.

7. The *Select Features* Dialog Box will be displayed if Custom was selected.

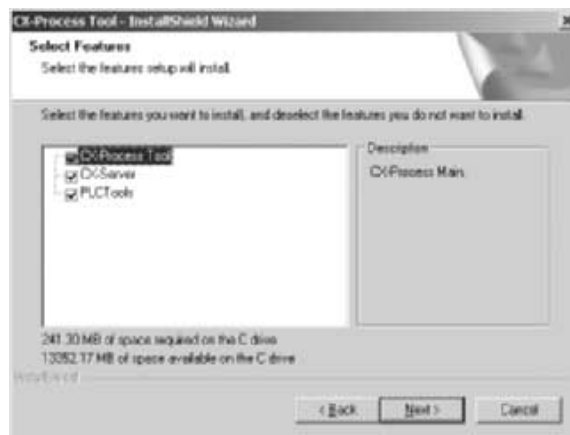

Note The above dialog box will not be displayed if *Complete* is selected. Proceed to step 8.

Select the features to be installed and click the **Next** Button.

Options

- CX-Process Tool
- CX-Server
- PLCTools

Note Only the CX-Server can be installed at the same time as the CX-Process Tool. To use FinsGateway as the communications server, refer to 2-1-5 *Installing FinsGateway*.

8. The *Select Program Folder* Dialog Box will be displayed.

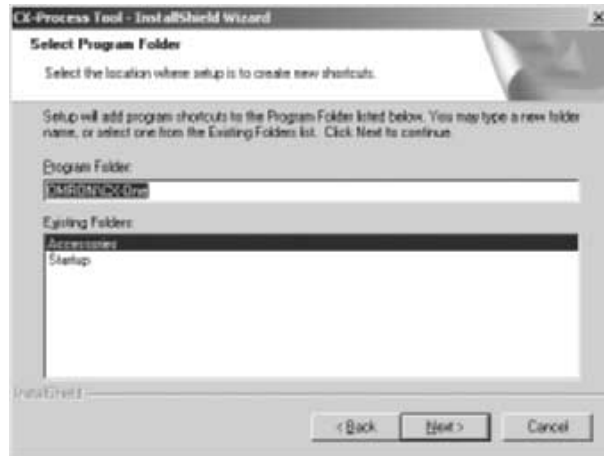

Specify the location to add a shortcut in the program folder of the Windows Start Menu and click the **Next** Button.

9. The *Ready to Install the Program* Dialog Box will be displayed.

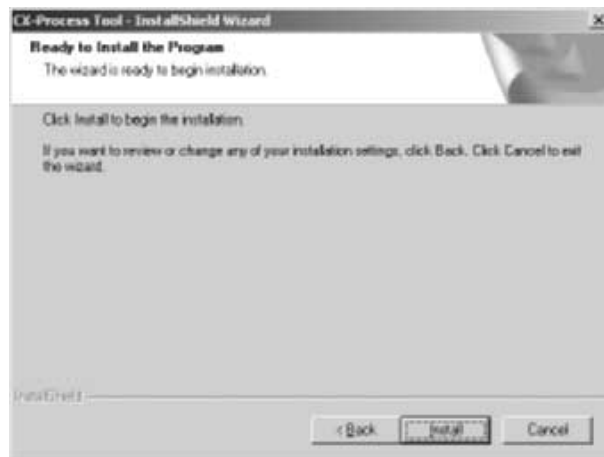

Click the **Install** Button.

The Installer will start the installation.

To check the installation settings, click the **Back** Button.

To cancel installation, click the **Cancel** Button.

10. If the CX-Server is already installed on the computer, the Installer will automatically check the CX-Server version and driver and update them as required. Depending on the version of CX-Server that was already installed, and confirmation dialog box may be displayed.

11. The following dialog box will be displayed when the Installer completes the installation. Click the **Finish** Button.



Note It might be necessary to restart Windows after completing the installation. If necessary, restart Windows according to the message from the Installer.

12. The Readme.txt file will be displayed after the computer is restarted.
 13. The *Online Registration* Dialog Box will be displayed when the Readme.txt file is closed.

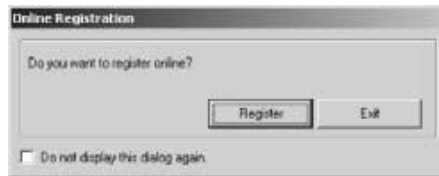

A wizard will be started and will connect to the OMRON CX-One Web if the **Register** Button is clicked. (See notes.)

- Note**
- If the **Exit** Button is clicked to cancel registration, the *Online Registration* Dialog Box will be displayed every time the CX-One Configuration Tool is started.
 - Online installation will not be possible if the computer is not connected to the Internet. Enter the required information on the registration card and mail it in.

This completes installation of the CX-Programmer.

2-1-5 Installing FinsGateway

One of the following communications drivers must be installed in the computer to enable using the CX-Process Tool.

- CX-Server (Installed at the same time as the CX-Process Tool.)
- FinsGateway Version 3 or higher

FinsGateway Version 3 or FinsGateway 2003 Embedded Version is bundled with the CX-Process Tool. Install one of the to use FinsGateway as the communications driver.

The FinsGateway Runtime Version can also be used. If the FinsGateway Runtime Version is already installed, it is not necessary to install an embedded version.

Preparations before Installing FinsGateway

- If FinsGateway Version 2 or lower is already installed, perform *Step 1: Backing Up the FinsGateway Settings* first.

- If FinsGateway is being installed for the first time, start the procedure from *Step 4: Internet Explorer Installation*.

Installing FinsGateway

Step 1: Backing Up the FinsGateway Settings

If necessary, back up the previous FinsGateway settings, as follows:

Note If FinsGateway is removed (uninstalled) without backing up the setting data, the previous setting data will all be lost.

- 1, 2, 3...**
1. Execute the Backup/Restore FinsGateway Setting Data program on the CD.

```
<CD-ROM drive>:\Fgwv3\FgwUtils\SettingSalvage.exe
```

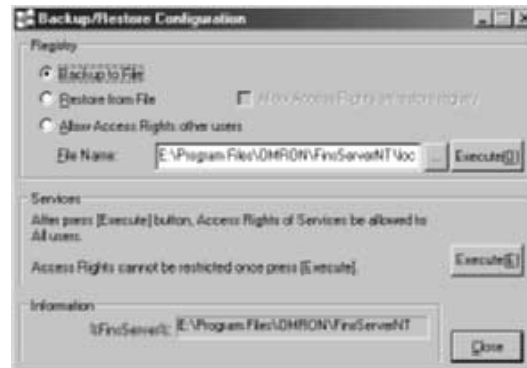

2. Select the Backup to File option, and click OK.

Step 2: Removing the Previous FinsGateway

Remove the previous version of FinsGateway by referring to that manual for details.

Note If the FinsGateway reinstallation process fails, execute the following program from the CD-ROM to remove all the files and registry data used by FinsGateway.

```
<CD-ROM drive>:\Fgwv3\FgwUtils\FgwRemover3.exe
```

Step 3: System Restart

After removing FinsGateway, restart the computer. If the following steps are performed without restarting the computer, the installation will not be completed properly.

Step 4: Internet Explorer Installation

If Internet Explorer is not already installed, or if the version is old, the FinsGateway installation will display a warning to update it. Update Internet Explorer.

Microsoft Internet Explorer is not included on the CD-ROM. Refer to the Microsoft website for details, and install the newest version.

Step 5: Updating ComCtl32.dll

If the program is not correctly displayed or does not operate correctly when using Windows NT 4.0, then update the ComCtl32.dll file. This is not necessary when using Windows 2000 or XP.

Use 401comupd.exe to update the ComCtl32.dll file. The 401comupd.exe file is an update program provided by Microsoft Corporation.

Step 6: Updating the HTML Help Runtime Component

If the HTML Help runtime component is not already installed, or if the version is old, the FinsGateway installation will display a warning to update it. Update the HTML Help runtime component as follows:

- 1, 2, 3...**
1. Execute the following program from the CD-ROM:

```
<CD-ROM drive>:\Fgwv3\Update\hhupd.exe
```
 2. Update the HTML Help runtime component according to the instructions displayed on the screen.
 3. The program will suggest a system restart when it finishes.
 Do not proceed to the next step without restarting the computer. If the instal-

lation is continued without restarting the computer, the FinsGateway will not operate properly.

2-1-6 Installing FinsGateway Embedded Version

The CX-Process Tool cannot be used if it is installed alone. Either the FinsGateway Embedded Version or CX-Server must be installed on the same computer as the communications driver.

The CX-Process Tool comes with FinsGateway Embedded Version 3 and 2003. Install either version. FinsGateway Runtime Version can also be used. If the Runtime Version has been already installed, there is no need to install the Embedded Version.

Using FinsGateway Version 3

The FinsGateway Update 3.12 software must be installed after the FinsGateway Embedded Version 3 software.

Installation of FinsGateway Version 3

- 1, 2, 3... 1. Select one of the following folders from within the Fgww3/FGW3ee folder. (Select the folder corresponding to the communications method being used in the PLC.)

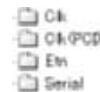

| Folder name | Details |
|-------------|---|
| Clk | Select this folder when connecting the PLC and personal computer (the CX-Process Tool and the CX-Process Monitor) via Controller Link using a Controller Link Support Board (ISA bus) installed in an ISA slot in the computer. |
| Clk (PCI) | Select this folder when connecting the PLC and personal computer (the CX-Process Tool and the CX-Process Monitor) via Controller Link using a Controller Link Support Board installed in the computer's PCI slot. |
| Etn | Select this folder to connect the personal computer (the CX-Process Tool and the CX-Process Monitor) to the PLC via Ethernet. |
| Serial | Select this folder to connect the personal computer (the CX-Process Tool and the CX-Process Monitor) to the PLC via the Host Link. |

The following procedure uses Host Link as an example.

- Using Windows Explorer or any other appropriate method, open **Serial** in the CD-ROM, and double-click the following icon inside the *disk1* folder.



The following screen will appear.



- Click the **Next** Button. The User Registration Dialog Box will appear.

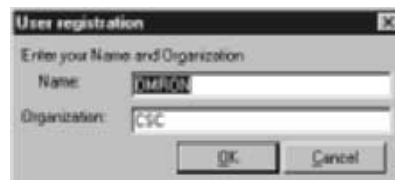

- Input the user name and the organization name and click the **OK** Button. The following Confirmation Dialog Box will appear.

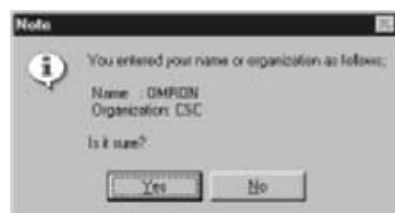

- Click the **Yes** Button. The following Choose Destination Location Dialog Box will appear.



- Click the **Yes** Button. The following Select Program Folder Dialog Box will appear.



- Check the installation folder and click the **Next** Button. Installation of the program will start. The following dialog box will appear when the installation has been completed.



- Click the **Finish** Button.

Installing FinsGateway Version 3 Update 3.12

- 1, 2, 3... 1. Using Windows Explorer or any other appropriate method, open the Fgwv3/FgwUpdate folder in the CD-ROM, and double-click the following icon.



2. The following screen will appear.

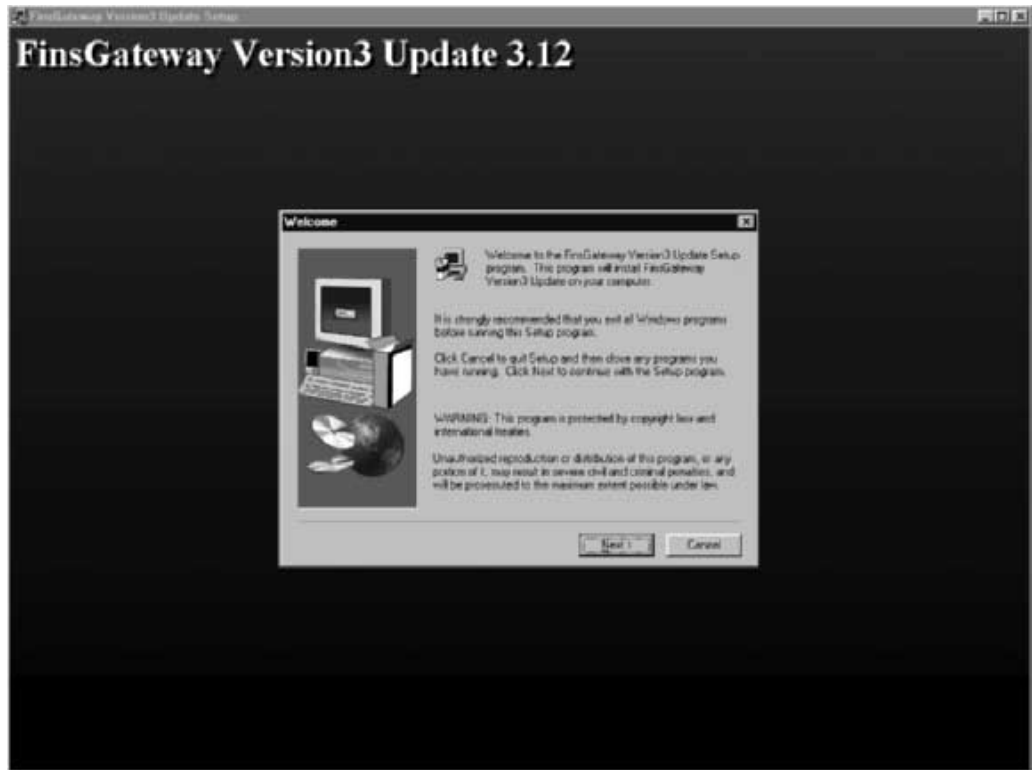

3. Click the **Next** Button. The following Information Dialog Box will appear.

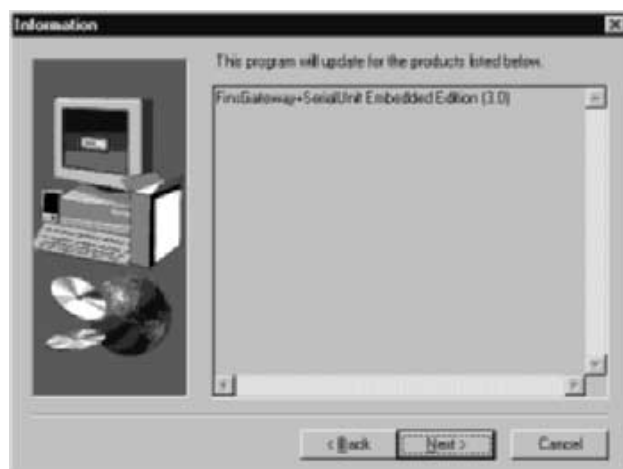

4. Check the installation folder and click the **Next** Button. The Start Copying Files Dialog Box will appear.



5. Check the installation folder and click the **Next** Button. Installation of the program will start. The following dialog box will appear when the installation has been completed.



6. Click the **Finish** Button.

Installing FinsGateway Version 2003

- 1, 2, 3... 1. Double-click **setup.exe** in the *Fgw2003* folder in the CD-ROM. The following screen will appear.



2. Click the **Next** Button to display the following screen.

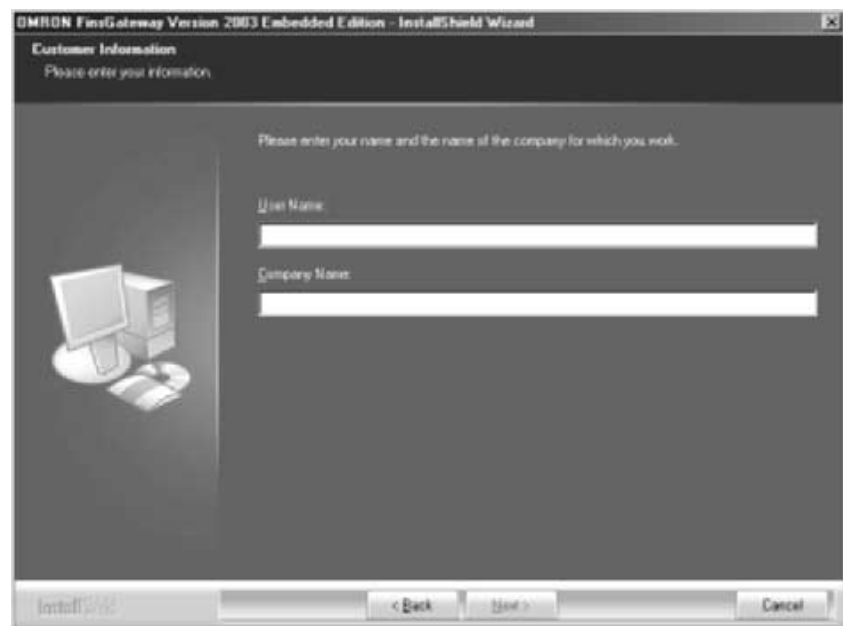

3. Input the user name and company name, and then click the **Next** Button.

4. Select the communications drivers that are required to run the CX-Process Tool.

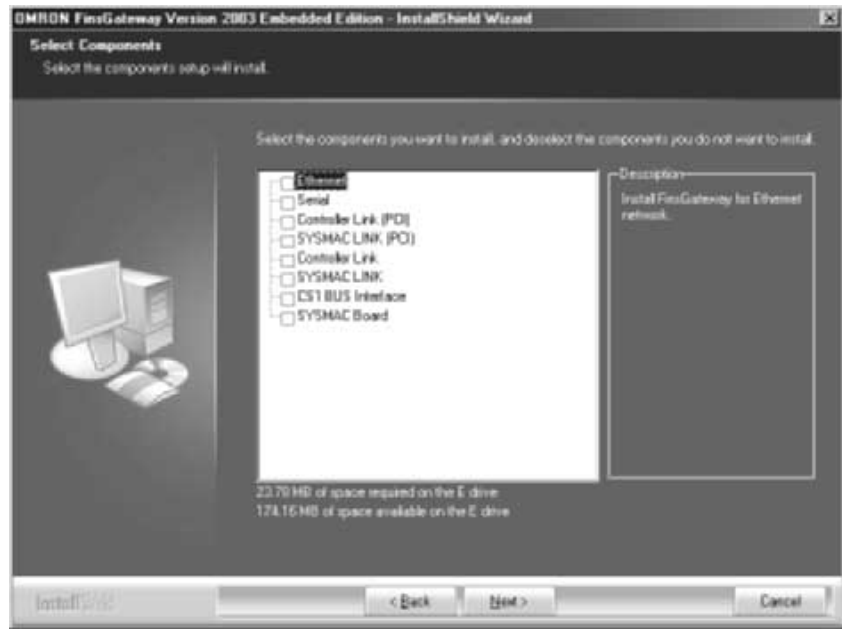

5. Click the **Next** Button.
6. Specify the installation folder. Unless a particular folder is required, use the default location and click the **Next** Button.
7. The following window will be displayed. Click the **Install** Button to begin installation.

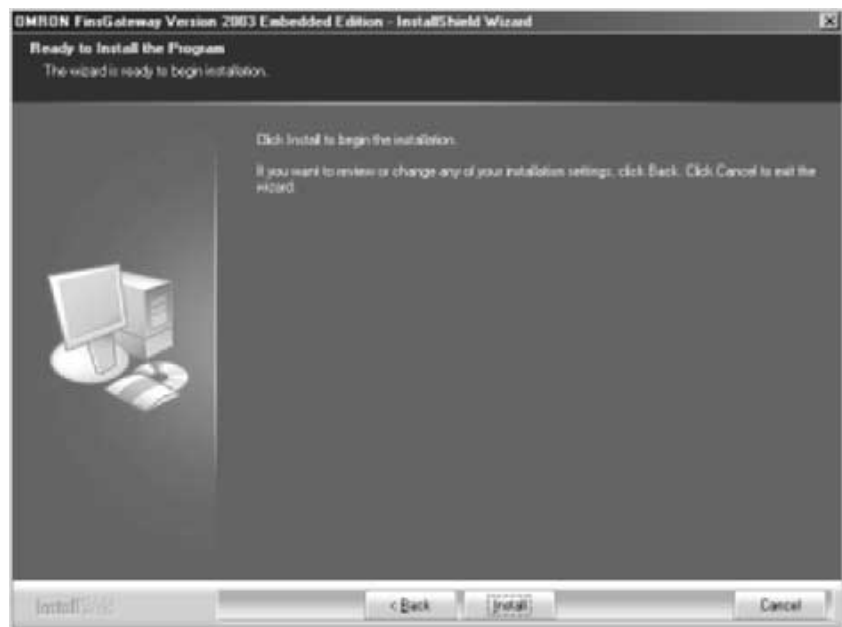

- The following screen will be displayed when installation has been completed. Click the **Finish** Button and restart the personal computer.



Installation is now completed.

2-1-7 Uninstalling the CX-Process Tool

Use the following procedure to delete the CX-Process Tool from the computer.

- 1, 2, 3...** 1. Select **Settings - Control Panel - Add/Remove Programs** or **Settings - Control Panel - Add/Remove Applications** from the Windows Start Menu.
2. Select **CX-Process Tool** from the dialog box.
3. Click the **Change/Remove** Button.

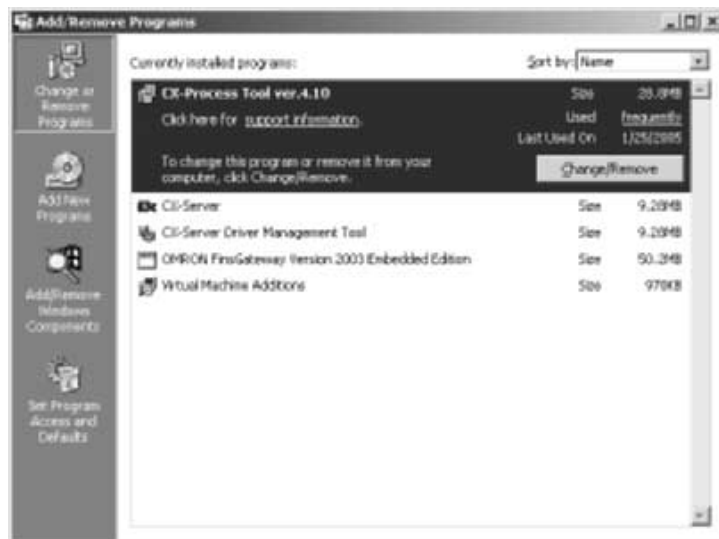

4. The CX-Process Tool Installation Wizard will be displayed. Select the *Remove* Option and click the **Next** Button.



5. If deleting the CX-Process Tool completely is selected, the following dialog box will be displayed. Click the **Yes** Button to start the Uninstaller that will delete the CX-Process Tool.

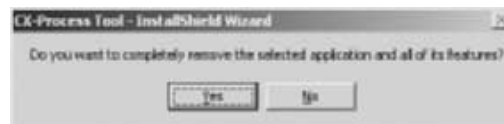

6. When the uninstallation has been completed, the following dialog box will be displayed.

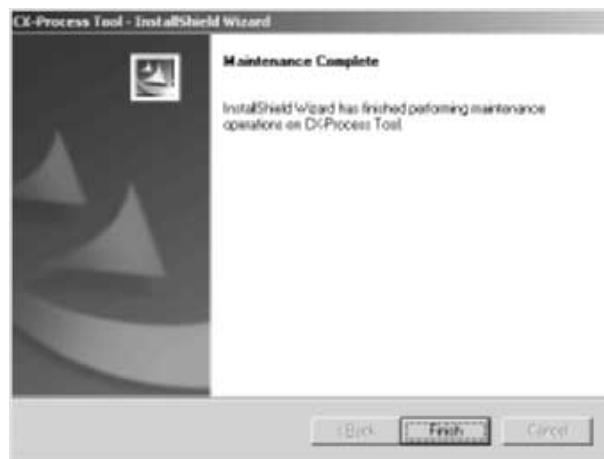

2-1-8 Uninstalling the CX-Server

- Note** (1) The Installer manages the version and driver for the CX-Server. If the CX-Server installed on the computer is old, the Installer will automatically update the CX-Server. If the CX-Server Driver Management Tool or the CX-Server is uninstalled from the control panel, it may no longer be possible to use certain Units. Do not uninstall the CX-Server Driver Management Tool or the CX-Server from the control panel.
- (2) Do not uninstall the CX-Server if there are Programming Devices (such as the CX-Programmer) that use it as the communications driver. If the CX-Server is uninstalled, it will no longer be possible to use these other programs.

- (3) Do not uninstall the CX-Server while other programs that use it as the communications driver are running on the computer, e.g., the CX-Motion. The CX-Server may not uninstall properly if other programs are using it.
 - (4) Always uninstall the CX-Server Driver Management Tool before uninstalling the CX-Server. If the CX-Server is uninstalled first, it may no longer be possible to uninstall the CX-Server Driver Management Tool properly.
- 1, 2, 3...**
1. Select **Settings - Control Panel - Add/Remove Programs** or **Settings - Control Panel - Add/Remove Applications** from the Windows Start Menu.



2. Select *CX-Server Driver Management Tool* from the dialog box.
3. Click the **Change/Remove** Button.

Note Always close the Control Panel before uninstalling the CX-Server Driver Management Tool from Windows 98 or Windows NT 4.0. The CX-Server Driver Management Tool cannot be uninstalled while the Control Panel is open.

4. A confirmation dialog box will be displayed. Click the **Yes** Button.

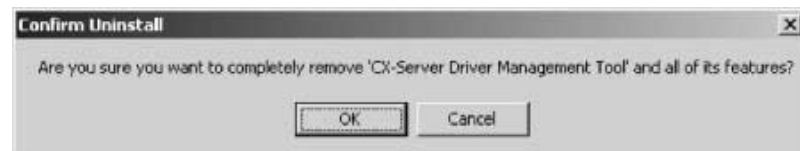

The CX-Server Driver Management Tool will be uninstalled.

- When the uninstallation has been completed, the following dialog box will be displayed. Click the **Finish** Button. The *Add/Remove Programs* Dialog Box will be displayed again.

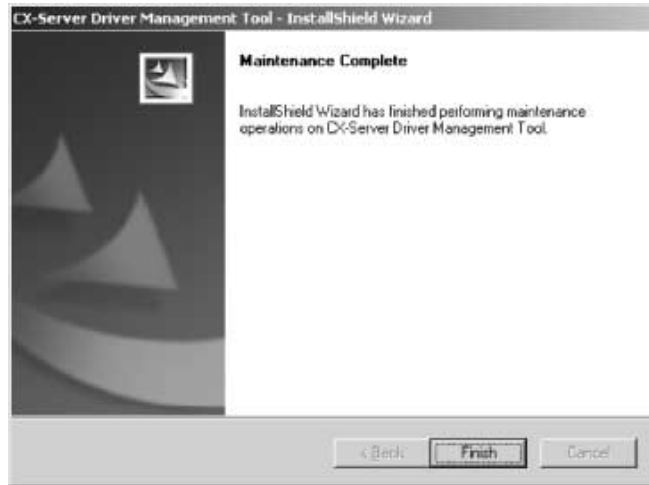

- In the same way, select *CX-Server* from the *Add/Remove Programs* Dialog Box, click the **Change/Remove** Button, and uninstall the *CX-Server* following the messages that appear on the screen.
- Reboot the computer.

2-1-9 Starting the CX-Process Tool

- 1, 2, 3...** 1. Select **Program - OMRON - CX-One - CX-Process Tool - CX-Process Tool** from the Windows Start Menu. The following dialog box will appear to select the communications driver.

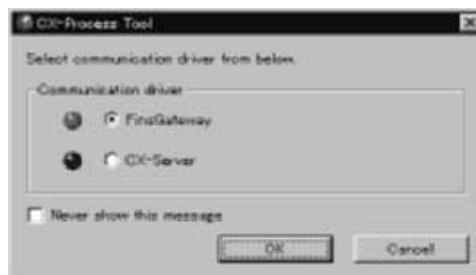

2. Select either FinsGateway or CX-Server as the communications driver and click the **OK** Button. The following screen will appear.

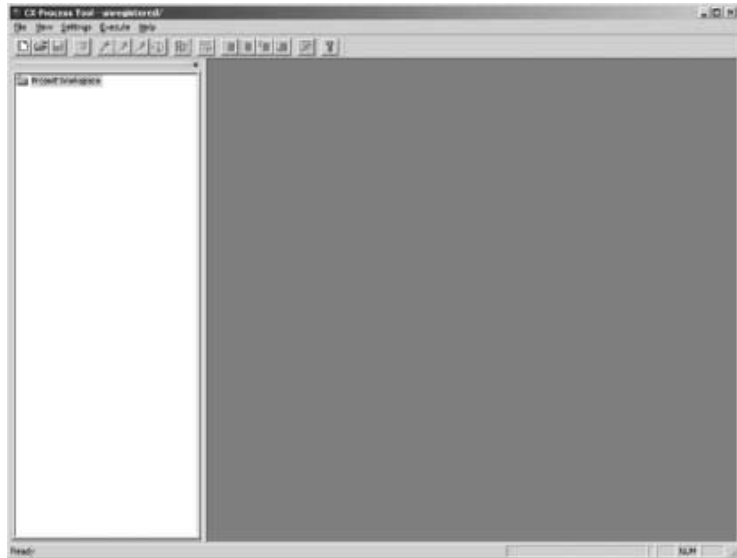

3. Refer to 3-1 *Creating Function Block* to continue.

Note The CX-Process Tool will not start with FinsGateway as the selected communications driver unless the FinsGateway Embedded Version 3 or higher has been installed in the computer. CX-Process Tool cannot be started using CX-Server if CX-Server is not installed.

2-2 Overview of User Interface

The CX-Process Tool consists of the following three basic panes (windows).

Project Workspace

Displays a data hierarchy tree.

Output Window

Displays execution results and error information, such as comparisons, tag error checks, and program transfers.

Contents Window

Displays the following contents:

- In Edit Block ITEM Mode, the contents of ITEMS in function blocks selected in the Project Workspace area on the left are displayed.
- In Edit Block Diagram Mode, function block connections in the block diagram selected in the Project Workspace area on the left are displayed.
- In Edit Step Ladder Diagram Mode, the ladder diagram for the Step Ladder Program Block selected in the Project Workspace area on the left is displayed.
- In Edit Sequence Table Mode, the sequence table for the Sequence Table Block selected in the Project Workspace area on the left is displayed.

Note Folders selected from the Project Workspace area are opened and function blocks selected from the Project Workspace area are all highlighted.

Operation via Menu and Toolbars

Functions, such as basic Windows operations, creating function blocks, and transfer operations, are available in the menu bar and the toolbar.

The screenshot displays the CI-Process Tool interface. At the top, a menu bar and toolbar are visible. The main workspace is divided into three primary areas:

- Project Workspace Area (Hierarchy):** Located on the left, it shows a tree view of project folders. The selected folder is 'Node01 : LCB05 V3.0 : [Z25]'. Below it, the 'Node function block folder' and 'LCU/LCB' are expanded, showing a list of function blocks with their addresses and names.
- Contents Window:** The central area displays a block diagram titled 'Cycle: System common operation cycle'. It features several interconnected function blocks, including 'Task Temp (PV1)', 'Rev PID (Loop2)', and 'Rev PID (Loop1)'. An annotation 'MVA+RSP of Loop2' is placed near the 'Rev PID (Loop2)' block.
- Output Window:** Located at the bottom, it shows a table of execution results.

Output Window

The name of the operation being executed, project information, and the execution results are displayed.

| No. | Result | Source | Destination |
|-----|--|--------|-------------|
| 1 | LCU No.00 The value of block address 001, Sen 002 is different | 53.00 | 1.00 |
| 2 | LCU No.00 The value of block address 001, Sen 004 is different | 1 | 0 |
| 3 | LCU No.00 The value of block address 002, Sen 009 is different | 90.00 | 100.00 |
| 4 | Finished verification. | | |

Contents Window

Contents of the various windows are displayed, such function block ITEMS, block diagrams, and step ladder programs. blocks selected in the Project Workspace area are displayed.

2-2-1 Project Workspace Tree

The Project Workspace tree shows the function block files, LCU/LCB elements, function block groups, and function blocks.

Project Workspace

- Pink folder
- Project folder name

Function Block File

- Active: Red
Inactive: White
- Node 01 to 32 (Node names cannot be changed.)
- Each node corresponds to one CPU Unit. (You can create up to three LCU elements and one LCB element under a node.)
- You can create up to 32 nodes in one Project Workspace.
- Displays the CPU Unit model for Loop-control CPU Units when FinsGateway is used as the communications driver.

LCU/LCB Element

- Yellow folders
- Set by default to LCB01, LCB05, LCB05D, or LC001-1 (Names can be changed.)
- "Not registered" will be displayed if no unit address has been set.
- The network address, node address, and unit address will be displayed after the unit address is set.

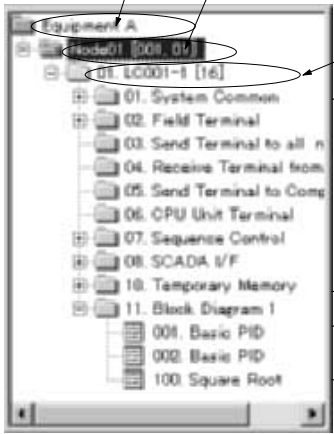

Function Block Group (Classified by the CX-Process Tool)

- Sky-blue folder
- Only block diagrams can be created.
- The name will be displayed after the function block group number. (Block diagram names can be changed.)

Function Blocks

- Icons indicating data (Selected: Red; Not selected: Blue)
- The function block names will be displayed after the block address.

| Name | Description | Example |
|-----------------------|---|-----------------|
| Project Workspace | Data consisting of up to 32 function block files. The same data capacity as a project folder. | Equipment A |
| Function block files | Data for a single PLC (CPU Unit). Consisting of up to three Loop Control Units and one LCB□□. | Node 01 |
| Loop Controller | Data for a single Loop Controller | LC001-1 |
| Function block groups | Classifications, such as block diagrams, determined by the CX-Process Tool. | Block diagram 1 |
| Function blocks | Individual function blocks | Basic PID |

Note To restore the original Project Workspace display (i.e., the display up to the function block file), right-click on the Project Workspace, and then select **Initialize Workspace Display** from the pop-up menu.

2-2-2 Output Window

The execution results of operations are displayed in the Output Window.



Project Information Display

The names of operations being executed are displayed, along with project information.

Results List Display

The execution results of operations shown in the Output Window are displayed.

Descriptions of Items

| Output Window | Contents | Example |
|-----------------------------|--|---|
| Project Information Display | Executed operations and related project information are displayed. | Result of model number conversion: LCB05GTC V3.0 to LCB05 V3.0 |
| Results List Display | Execution results are displayed for the following operations: <ul style="list-style-type: none"> • Comparisons • CX-Process Monitor, CSV, and CX-Process Monitor checks • Step ladder program assembly and reverse assembly • Sequence table error checks • User-defined block exporting and importing • Program transfers (displayed only when an error occurs) | Block Number 021 cannot be converted (Block Number 001). |

Jumping

- Double-clicking on an error message causes the display to jump to the relevant location.
- Pressing the F4 Key causes the display to jump to the relevant location for the next error message.

Note The display does not jump to the relevant display message location in the following cases:

- When the node file, LCB or LCU element, function block group, or function block at the specified jump destination does not exist.
- When the specified jump destination is not an active node.

Copying

- 1, 2, 3... 1. Select **Copy All** from the pop-up menu in the Output Window. (Right-click to display the pop-up menu.)
2. Select **Paste** to paste the contents of the Output Window display into a spreadsheet, such as one created with Excel.

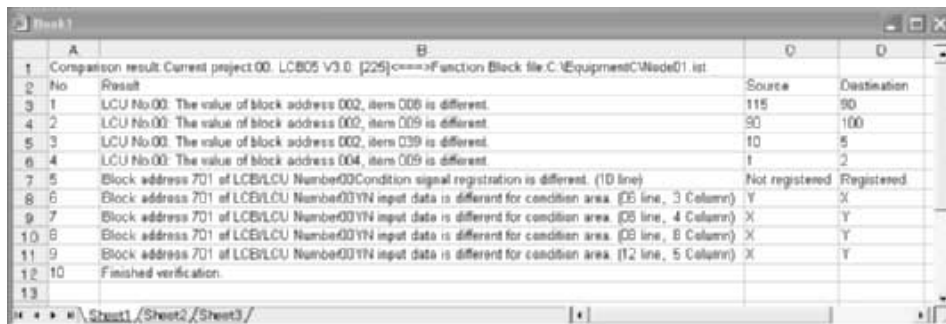

Note To clear the display, select *Clear* from the pop-up menu.

2-2-3 Menus

Menus in Edit Block ITEM Mode

Main Menu

| Menu | Submenu/ Command | Description | Conditions for selection | |
|-----------------------------|---------------------|---|---|--|
| File | New | Creates a Project Workspace and project. | --- | |
| | Open | Opens a multi-node file in the current project folder. All related files are opened automatically. | | |
| | Close | Closes the current Project Workspace. | | |
| | Save | Saves the current Project Workspace and overwrites the previous one in the project folder. | | |
| | Save As | Saves the current Project Workspace in a different project folder. | | |
| | Add IST File | Imports a function block file (.ist) created in version 1.00 into the current Project Workspace. Note If the active function block file has been changed, it must be saved before executing the above. | | |
| | Sort | Manual | | Sorts function block files in order of node numbers. |
| | | Auto | | If checking is enabled, function block files are read in order of node numbers when Add IST File or Open is selected. |
| | Page Settings | Block Diagram | | Used to select one of the following page formats when printing block diagrams. A4 landscape, A4 portrait, A3 landscape, A3 portrait (The printing size must also, however, be matched to the setting.) |
| | Print | Function Block | | Prints a list of registered function blocks and a list of all ITEMS. |
| | | Block Diagram | | Prints block diagrams. |
| | | Cross-Reference | | Prints cross-references. |
| | | Sequence Control | | Prints sequence tables. |
| | | All | | Prints all of the above. |
| | | Monitor Tag List | | Prints the monitor tag list. |
| | | CSV Tag List | | Prints a list of CSV tags. |
| | | Monitor Plus Tag List | | Prints a list of CX- Process Monitor Plus tags. |
| | | User Link table | | Prints user link tables. |
| | | Connection Map | | Prints a connection map. |
| | Recent File | | Displays up to the four files most recently used. | --- |
| Activate Serial Port Driver | | Connects to the PLC via Host Link. | | |
| Find LCU | | Displays the serial (Host Link), Controller Link, or Ethernet Link networks of the PLC to which the CX-Process Tool is connected and searches for Loop Controllers. It gets the network addresses, node addresses, and unit address of all Loop Controllers found and sets them in the currently active node function block file. | When an LCU or LCB element is selected | |

| Menu | Submenu/Command | | Description | Conditions for selection |
|-----------------|------------------------------|--------------------------------------|--|---|
| File, continued | Show Driver Select Dialog | Show | The Communications Driver Dialog Box will be displayed when the CX-Process Tool starts. | When an LCU or LCB element is selected |
| | | Hide | The Communications Driver Dialog Box will not be displayed when the CX-Process Tool starts. | |
| | Exit | Exits the CX-Process Tool. | | --- |
| View | Toolbar | | Displays or hides the toolbar. | |
| | Project Workspace | | Displays or hides the Project Workspace area. | |
| | Output Window | | Displays or hides the Output Window. | |
| | Engineering Unit Mode | View | Toggles between Engineering Unit mode and Percentage Mode. | |
| | | Assert Rounding Errors | Toggles between displaying and hiding the Engineering Unit Assert Rounding Errors Dialog Box. | |
| Settings | Activate Function Block File | | Activates the selected function block file so that the file can be edited or operated online. When the file is activated, the function block file on the tree will turn red. Note If the current function block file has been changed, it must be saved before executing this command. | When a function block file is selected |
| | Network Settings | | Sets the network address, node address, and unit address. | When a function block file or LCU/LCB element is selected |
| | Change PLC | | Makes initial settings for online connections such as the PLC model and network type settings when connecting online with CX-Server. | When a function block file is selected |
| | Tag Setting | Monitor Tag (Loop Control Unit only) | Sets tags for CX-Process Monitor (with the tag names, tag comments, scaling, and units). | When a Block Send Terminal to Computer or Area to Send to All Nodes Function Block is selected |
| | | CSV Tag | Sets CSV tags for each function block for output to SCADA software. Tags include the tag name, tag comment, scaling, unit, etc. Note The tag names are representative tags. The ITEM tags under the tags are predetermined and fixed for each function block. These can be saved in CSV format as CSV tag files. | When a function block file is selected |
| | | Monitor Plus Tag | Sets tags for CX-Process Monitor Plus (with the tag names, tag comments, scaling, and unit). | When a Send All Blocks, Receive All Blocks, Contact Distributor, Internal Switch, Input Selector, or Constant Generator block is selected |

| Menu | Submenu/ Command | | Description | Conditions for selection |
|------------------------|---------------------|--|--|---|
| Settings, continued | Insert | Insert Node | Creates and inserts a function block file (.ist) into the Project Workspace. Note If the current function block file has been changed, it must be saved before executing this command. | When the Project Workspace is selected |
| | | Insert LCB/LCU | Creates and inserts an LCU or LCB element into a function block file. The LCU/LCB numbers and corresponding model numbers are as follows: 00-LCB01: LCB01 Ver. 1.0 or later 00-LCB03: LCB03 Ver. 2.0 or later 00-LCB05: LCB05 Ver. 1.0 or later 00-LCB05D: LCB05D Ver. 1.0 or later 01-LC001: CS1W-LC001 02-LC001: CS1W-LC001 03-LC001: CS1W-LC001 | When a function block file is selected |
| | | Insert Block Diagram | Inserts a block diagram. | When an LCU or LCB element is selected |
| | | Insert Function Block | Creates and adds a function block. | When a function block group is selected |
| | Delete | When the current function block file or LCU/LCB element is selected: Deletes the function block file. When a function block is selected: Deletes the selected function block. | | When a function block file, LCU/LCB element, block diagram, or function block is selected |
| | Edit | Edit Function Block ITEMs | Edits function block ITEMS. | When a function block is selected |
| | | Edit Block Diagram | Sets the CX-Process Tool to Edit Block Diagram Mode and make the software connection between function blocks. The edit block diagram menu will be explained later. | When the block diagram is selected |
| | | Edit Step Ladder Program | Sets the CX-Process Tool to Edit Step Ladder Program Mode and edits the instructions in a Step Ladder Program Block (block model 301). The Edit Step Ladder Program Menu will be explained later. | When a step ladder program is selected |
| | | Edit Se- quence Table (LCB05 or LCB05D only) | Edits a sequence table (Block Model 302). Editing a sequence table must be enabled after double-clicking on the editing screen before this command can be used. | When a sequence table is selected |
| | | Edit User Link Table | Edits a user link table. | When a function block file, LCB element, function block group, or a function block file is selected |

| Menu | Submenu/Command | | Description | Conditions for selection |
|---------------------|-------------------------------|-------------------------|---|---|
| Settings, continued | Function Block | Cut | Cuts a function block from the Project Workspace. | When a function block file is selected |
| | | Copy | Copies a function block in the Project Workspace. | |
| | | Paste | Pastes a function block in the Project Workspace. | |
| | | Increment Block Address | Selects and increments the function block address by 1. If the next address is being used, it is also incremented by 1. Note If the current function block file has been changed, it must be saved before executing this command. | |
| | FBD | Copy | Copies the entire block diagram (function block group). | When a block diagram (function block group) is selected |
| | | Paste | Registers the copied block diagram as a new block diagram in the selected LCU/LCB element. | When an LCU or LCB element is selected |
| | User-defined Blocks | Create | Sets the selected block diagram as a user-defined block. The input interface and output interface are automatically pasted. | When a block diagram is selected |
| | | Release | Returns the selected user-defined block to a normal block diagram. The input interface and output interface are automatically deleted. | When a user-defined function block group is selected. |
| | | Import | Reads a user-defined block from a file (.ucb) and inserts it as a block diagram in the selected LCU or LCB element. | When an LCU or LCB element is selected |
| | | Export | Writes the selected user-defined block to a file (.ucb). | When a block diagram is selected |
| | Setting Block Operating Order | | Automatically sets the order of execution of the function blocks. | When an LCU or LCB element is selected |
| | Import CX-Programmer Symbols | | Imports the symbol information from the current CX-Programmer project to a user link table. | When the CX-Programmer is running |
| | Program Protection | Input Password | Used to input a password. If the same password as was used for Program Protection/Edit LCB Password is input, the function block data in the Loop Controller can be uploaded. | When an LCB element is selected |
| | | Clear Password | Clears the password that was entered with Program Protection/Input Password . Note Clear Password does not delete the password that is set, i.e., it merely restores protection so that the password must be input again before uploading data. | When an LCB element is selected |
| | | Edit LCB Password | Used to set or change the password of a Loop Controller connected online. The function block data in the Loop Controller cannot be uploaded unless the password set here is input for Program Protection/Input Password . | When an LCB element is selected |
| | Option | | Used to set options for the Project Workspace (i.e., for the project). | --- |

| Menu | Submenu/ Command | | Description | Conditions for selection |
|------------------------|---------------------|--|--|--|
| Settings, continued | PLC Info | Create I/O Table (applicable only when CX-Server is used as the communications driver) | Creates I/O tables in the CPU Unit from the CX-Process Tool. | --- |
| | | PLC Setup (applicable only when CX-Server is used as the communications driver) | Makes settings in the PLC Setup in the CPU Unit from the CX-Process Tool. | --- |
| Execution | Create Tag File | Monitor Tag (Loop Control Unit only) | Creates a file for the CX-Process Monitor. (The CX-Process Monitor must be installed in advance.) | --- |
| | | CSV Tag | Creates a CSV tag file based on CSV tag settings and settings in the Send/Receive All Blocks blocks (Block Model 462/461). | --- |
| | | RS View Tag | Creates a tag file for the RS View. | --- |
| | | Monitor Plus Tag | Creates a file for the CX-Process Monitor Plus. | --- |
| | | Create HMI I/F Memory Map | Outputs the HMI memory allocations to a CSV file (shows the address in the EM Area allocated to each tag and tag ITEM). | --- |
| | | Start NSFP | Starts the Faceplate Auto-Builder for NS after CSV tags are compiled. | --- |
| | Show Tag List | Monitor Tag (Loop Control Unit only) | Displays information (tag names, data exchange function blocks, etc.) for the CX-Process Monitor tags that have been set. | When an LCU element, function block file, or Project Workspace is selected |
| | | CSV Tag | Displays tag information set for SCADA software (including the tag names, block addresses, function block names, scaling, units, etc.) | When an LCU/LCB element, function block file, or Project Workspace is selected |
| | | Monitor Plus Tag | Displays information (tag names, data exchange function blocks, etc.) for the CX-Process Monitor Plus tags that have been set. | When an LCU/LCB element, function block file, or Project Workspace is selected |
| | Check Tag Error | CSV Tag | Checks a compiled CSV tag file for errors. | --- |
| | | Monitor Plus Tag | Checks a compiled Monitor Plus tag file for errors. | --- |

| Menu | Submenu/Command | | Description | Conditions for selection |
|----------------------------------|--------------------|--|---|--|
| Execution, continued | Transfer to LC | Selected | Transfers the data in the specified Loop Controller or function block in the current function block file to the specified Loop Controller connected online. | When a Loop Controller is selected or function block is selected |
| | | FBD Information | Downloads layout information for a function block connection diagram to an LCB□□. | When an LCB element, function block, or function block diagram is selected |
| | | Memory Card | Transfers function block connection diagrams, tags, comments, and annotations to a Memory Card. | When a Loop Controller is selected |
| | | Tag Data | Transfers block diagram data, tags, comments, and annotation data to a Memory Card. (LCB01/LCB05/LCB05-GTC version 3.0 or higher) | When a Loop Controller is selected |
| Transfer from LC | Previous | Uploads function block data from the specified Loop Controller connected online to replace the data in the Loop Controller in the current function block file or the current function block. | When a Loop Controller, function block, or function block diagram is selected | |
| | New | Newly uploads function block data from the specified Loop Controller connected online to be read to the Loop Controller in the current function block file or the current function block. | When a Loop Controller is selected | |
| Operation | Run/Stop Command | Starts or stops the Loop Controller, including hot or cold starts. | When the selected item is not the Project Workspace or the function block file | |
| | Monitor Run Status | Executes monitor control of the System Common block. | | |
| | Clear All | Clears function block data from the Loop Controller. | | |
| Compare with LC | | Compares the data in the current function block file and the data in the Loop Controller connected online or data in a file. Also compares the data in the current function block file and the data in another file. | When the selected item is not the Project Workspace | |
| Monitor | ITEM List | Monitors (lists) all of the selected function block's ITEM data. It is also possible to download the data of individual ITEMS. | When the cursor is positioned on a function block that has been pasted | |
| | Tuning Screen | Makes online changes to settings such as the function block's PID constants and SPs. | | |
| | All Stop | Stops all windows in which diagrams are being validated, ITEM lists are being monitored, and tuning screens are being displayed. | When the selected item is not the Project Workspace | |
| Backup Data Operation | Backup | Copies the function block data in the RAM in the Loop Controller to the flash memory in the Loop Controller. | When a Loop Controller is selected | |
| | Recovery | Restores the function block data in the flash memory in the Loop Controller to the RAM in the Loop Controller. | | |
| Check Version | | Checks whether the version of the Loop Controller connected on line agrees with the version of the CX-Process Tool, and displays the result. | When a Loop Controller is selected | |
| Delete Registered Function Block | | Execution | Deletes the registered function block (in the Loop Controller) while online. | When a function block is selected |

| Menu | Submenu/Command | | Description | Conditions for selection |
|----------------------|--|---|---|---|
| Execution, continued | Find | Block Number | Searches for registered function blocks with the block number that has been specified, and moves the cursor to the function block with the matching block number in the Project Workspace. | When a Loop Controller is selected |
| | | Monitor Tag | Searches for the Monitor Software tag name that has been specified, moves the cursor to the function block with the matching monitor tag in the Project Workspace. | When a Loop Controller is selected |
| | | CSV Tag | Searches for the tag name for SCADA software that has been specified, and moves the cursor to the function block with the matching CSV tag (tag for SCADA software) in the Project Workspace. | When a Loop Controller, node function block file, or Project Workspace is selected |
| | | User Link Table | Finds the tag name for the user link table related to a selected field terminal. | When a field terminal is selected |
| | Convert Ladder to Mnemonics per LCU/LCB | | Converts all the ladder diagrams in the Loop Controller into mnemonics. | When an LCU or LCB element is selected |
| | Cross-Reference | | Displays the cross-references of the selected step ladder program, i.e., what instructions use contact ITEMS. | When an LCU or LCB element is selected |
| | Connection Map | | Displays the relationship between inputs and outputs for the selected function block | When function block file for a node is selected |
| | Show Memory Map | | The status showing how the Loop Controller is using CPU Unit memory can be displayed as a list. | When an LCU or LCB element is selected |
| | PLC Operating Mode (applicable only when CX-Server is used as the communications driver) | | Changes the operating mode of the CPU Unit from the CX-Process Tool. | When a function block file, LCU/LCB element, function block group, or function block file is selected |
| | Change LC Type | | Converts the selected Loop Controller type, number-model, and unit version when inserting an LCU/LCB element. | When an LCB element is selected |
| Window | Cascade | | Overlaps and displays windows. | --- |
| | Tile Horizontally | | Displays windows side by side. | |
| | Arrange Icons | | Aligns icons. | |
| | Close | All | Closes all open windows. | |
| | | Block Diagram | Closes all open block diagram windows. | |
| | | Ladder Diagram | Closes all open ladder diagram windows. | |
| | | Sequence Table | Closes all open sequence table windows. | |
| | | Cross-Reference | Closes all open cross-reference windows. | |
| | | Connection Map | Closes all open connection map windows. | |
| | | User Link Table | Closes all open user link table windows. | |
| Close All | | Closes all open windows. | | |
| Recent windows | | Displays up to the nine windows most recently used. | | |

| Menu | Submenu/Command | Description | Conditions for selection |
|------|--------------------------|--|--------------------------|
| Help | Contents | Displays PDF file. | --- |
| | PBPC Web | Accesses the OMRON PLC website. (A browser plug-in is required.) | |
| | Function Block Reference | Displays reference help for the selected block type. | |
| | About CX-Process | Displays the version of the CX-Process Tool. | |
| | Online registration | Registers user online. | |

Pop-up Menus (Menus Displayed by Clicking Right Button)

| Pop-up menu command | | Description | Conditions for selection |
|---------------------|--|---|---|
| Tag Setting | Monitor Tag | Same as selecting Tag Setting/Monitor Tag from the Settings Menu. | When a Block Send Terminal to Computer or Area to Send to All Nodes is selected |
| | CSV Tag | Same as selecting Tag Setting/CSV Tag from the Settings Menu. | When a function block is selected |
| | Monitor Plus Tag | Same as selecting Tag Setting/Monitor Plus Tag from the Settings Menu. | When a Send All Blocks, Receive All Blocks, Contact Distributor, Internal Switch, Input Selector, or Constant Generator block is selected |
| Network Settings | | Same as selecting Network Settings from the Settings Menu. | When a function block file or LCU/LCB element is selected |
| Change PLC | | Same as selecting Change PLC from the Settings Menu. | When a function block file is selected |
| Insert | Same as selecting Insert Node from the Settings Menu. | | When the Project Workspace is selected |
| | Same as selecting Insert LCU/LCB from the Settings Menu. | | When a function block file is selected |
| | Same as selecting Insert Block Diagram from the Settings Menu. | | When an LCU or LCB element is selected |
| | Same as selecting Insert Function Block from the Settings Menu. | | When a function block group is selected |
| Delete | | Same as selecting Delete from the Settings Menu. | When a function block file or LCU/LCB element or block diagram or function block is selected |
| Function Block | Cut | Same as selecting Function Block/Cut from the Settings Menu. | When a function block is selected |
| | Copy | Same as selecting Function Block/Copy from the Settings Menu. | When a function block is selected |
| | Paste | Same as selecting Function Block/Paste from the Settings Menu. | When a function block is selected |
| | Increment Block Address | Same as selecting Function Block/Increment Block Address from the Settings Menu. | When a function block is selected |
| FBD | Copy | Same as selecting FBD/Copy from the Settings Menu. | When a block diagram is selected |
| | Paste | Same as selecting FBD/Paste from the Settings Menu. | When an LCU or LCB element is selected |
| User-defined Block | Create | Same as selecting User-defined Block/Create from the Settings Menu. | When a function block diagram is selected |
| | Release | Same as selecting User-defined Block/Remove from the Settings Menu. | When a user-defined block is selected |
| | Import | Same as selecting User-defined Block/Import from the Settings Menu. | When an LCU or LCB element is selected |
| | Export | Same as selecting User-defined Block/Export from the Settings Menu. | When a function block diagram is selected |

| Pop-up menu command | | Description | Conditions for selection |
|------------------------------|---|--|--|
| Monitor | ITEM List | Same as selecting Monitor/ITEM List from the Execution Menu. | When the cursor is positioned on a function block that has been pasted |
| | Tuning Screen | Same as selecting Monitor/Tuning Screen from the Execution Menu. | |
| Transfer to LC | | Same as selecting Download from the Execution Menu. | When an LCU or LCB element is selected or function block is selected |
| Transfer from LC | Previous | Same as selecting Upload/Upload Previous from the Execution Menu. | Upload Previous: When an LCU/LCB element, or function block is selected |
| | New | Same as selecting Upload/Upload New from the Execution Menu. | Upload New: When an LCU or LCB element is selected |
| Operation | Run/Stop Command | Same as selecting Operation and then Run/Stop Command from the Execution Menu. | When an LCU/LCB element, function block group, or function block file is selected |
| | Monitor Run Status | Same as selecting Operation/Monitor Run Status from the Execution Menu. | |
| | Clear All | Same as selecting Operation/Clear All from the Execution Menu. | |
| Find | Block Number | Same as selecting Find/Block Number from the Execution Menu. | When an LCU or LCB element is selected |
| | Monitor Tag | Same as selecting Find/Monitor Tags from the Execution Menu. | When an LCU/LCB element is selected |
| | CSV Tag | Same as selecting Find/CSV Tags from the Execution Menu. | When a Loop Controller, node function block file, or Project Workspace is selected. |
| | User Link Table | Finds the tag name for the user link table related to a selected field terminal. | When a field terminal is selected. |
| Edit | Block ITEMS | Same as selecting Edit/Function Block ITEMS from the Settings Menu. | When a function block is selected |
| | Block Diagram | Same as selecting Edit/Block Diagram from the Settings Menu. | When a block diagram is selected |
| | Ladder Program | Same as selecting Edit/Ladder Program from the Settings Menu. | When a step ladder program is selected |
| | Sequence Table | Same as selecting Edit/Edit Sequence Table from the Setting Menu. | When a sequence table is selected |
| List | Monitor Tag | Same as selecting Display Tag List/Monitor Tags from the Execution Menu. | When an LCU or LCB element is selected, node function block file, or Project Workspace is selected |
| | CSV Tag | Same as selecting Display Tag List/CSV Tag from the Execution Menu. | |
| | Monitor Plus Tag | Same as selecting Display Tag List/Monitor Plus Tags from the Execution Menu. | |
| | User Link Table | Same as selecting Edit/User Link Table under the Settings Menu. | |
| | Cross-Reference | Same as selecting Cross Reference from the Execution Menu. | When an LCU or LCB element is selected |
| | Connection Map | Same as selecting Connection Map from the Execution Menu. | When a function block folder or function block file is selected |
| | Memory Map | Same as selecting Memory Map under the Execution Menu. | When a Loop Controller is selected |
| Activate Function Block File | Same as selecting Activate Function Block File from the Settings Menu. | When a function block file is selected | |
| Rename | Same as selecting Rename from the Settings Menu. | When an LCU/LCB element, function block group, or step ladder program is selected | |

| Pop-up menu command | Description | Conditions for selection |
|--------------------------|---|---|
| System Job Information | Displays the System Job Information Dialog Box for the Project Workspace level. | When an LCU or LCB element is selected, function block group, or function block is selected |
| Function Block Reference | Displays the reference help for the selected function block. | When a function block is selected |

Menus in Edit Block Diagram Mode

Select the block diagram first, and then select **Edit - Edit Block Diagram** from the Settings Menu so that the CX-Process Tool will enter Edit Block Diagram Mode. The following menus will be displayed.

Main Menus

| Menu | Command | | Description |
|------------------------------|-------------------------|--|---|
| View | FB Registration Bar | | Displays or hides the function block registration bar. |
| Scale | 100% | | Displays the block diagram in actual size (default). |
| | 200% | | Displays the block diagram at 200% size. |
| | 50% | | Displays the block diagram at 50% size. |
| | Zoom In | | Zooms in to the block diagram. |
| | Zoom Out | | Zooms out from the block diagram. |
| Change Mode | Grid Mode | Grid OFF | Turns OFF the grid display. |
| | | Wide | Switches the grid to a wide grip. |
| | | Middle | Switches the grid to a midsize grid. |
| | | Narrow | Switches the grid to a narrow grid. |
| | CSV Tag mode | | If CSV tags have been set, the CSV tag name is displayed as the function block name when a function block is pasted in the block diagram. |
| Manipulate FBD | Setting Operation Order | Common | Sets the execution cycle for all function blocks in a function block diagram. |
| | | 0.01 sec | |
| | | 0.02 sec | |
| | | 0.05 sec | |
| | | 0.1 sec | |
| | | 0.2 sec | |
| | | 0.5 sec | |
| | | 1.0 sec | |
| | | 2.0 sec | |
| | Download | | Downloads only the function blocks actually set above to the Loop Controller. |
| | Copy FBD | | Copies the entire block diagram (function block group). The block diagram that was copied can be used as follows: If an LCU/LCB element is selected, the pop-up menu is accessed by double-clicking, and Block Diagram/Paste is selected, the Block Diagram Dialog Box will be displayed. If a function block group number and title are input and then the OK button is clicked, the block diagram that was copied will be added as a new function block group. |
| | Selected Annotation | Edit | Edits the selected annotation. |
| | | Delete | Deletes the selected annotation. |
| | | Bring to Front | Displays the selected annotation in front of other annotations. |
| | | Send to Back | Displays the selected annotation behind other annotations. |
| Send Behind Blocks and Lines | | Makes the selected annotation transparent. | |
| Font Size | | Changes the selected annotation's font size. | |
| Undo | | Reverses (undoes) the last operation. | |
| Validate Action | Start | | Starts checking the operation of software connections. |
| | Exit | | Ends checking the operation of software connections. |

Pop-up Menus (Menus Displayed by Clicking Right Button)

| Pop-up menu command | | Description | Conditions for selection | |
|-------------------------------|---------------------|--|--|--|
| Paste: Function Block | | Pastes a function block selected on the Project Workspace Screen to the desired position. | When the cursor is in the position where a function block can be pasted | |
| Delete Function Block Diagram | | Deletes a function block that was pasted. | When the cursor is on a function block to be deleted | |
| Register | Control Block | Directly registers a Control block in the block diagram. | --- | |
| | Field Terminal | Directly registers a Field Terminal block in the block diagram. | --- | |
| | Sequence Control | Directly registers a Sequence Control block in the block diagram. | --- | |
| | User Link Table | Link Input (Read from CPU Memory) | Directly registers a User Link Table block used to read data from the CPU Unit in the block diagram. | --- |
| | | Link Output (Write to CPU Memory) | Directly registers a User Link Table block used to write data to the CPU Unit in the block diagram. | --- |
| | Register Block Cell | Registers a cell in the User Link Table block that was pasted. | When the cursor is at the position in which the User Link Table block was pasted | |
| | Remove Block Cell | Removes a cell from the User Link Table block that was pasted. | When the cursor is at a cell registered in the User Link Table block was pasted | |
| | User-defined Block | Edit Analog I/O Cell | Used to edit the input interface or output interface of a user-defined block | When an input or output interface for a user-defined block is selected |
| | | Delete Analog I/O Cell | Deletes the input interface or output interface of a user-defined block | |
| Insert User-defined Block | | Inserts a user-defined block into the block diagram. | When the cursor is positioned where a function block can be pasted | |
| Monitor | ITEM List | Same as selecting Monitor/ITEM List from the Execution Menu. | When the cursor is positioned on a function block that has been pasted | |
| | Tuning Screen | Same as selecting Monitor/Tuning Screen from the Execution Menu. | When the cursor is positioned on a function block that has been pasted | |
| Validate Action | Start | Starts the validation of open block diagrams. | --- | |
| | Stop | Stops the validation of open block diagrams. | --- | |
| Delete Line | | Deletes software connection line between function blocks when the line itself has been selected (displayed in red). | When the cursor is on a line | |
| Release Selection | | Clears the selection of lines selected by clicking the left mouse button on function blocks or ITEMS (displayed in pink). | --- | |
| Delete selected lines | | Deletes all the lines that have been selected by clicking the left mouse button on function blocks or ITEMS (displayed in pink). | When the cursor is positioned on a function block that has been pasted or when an ITEM has been selected (displayed in pink) | |

| Pop-up menu command | | Description | Conditions for selection | |
|--------------------------|---|---|--|--------------------------------|
| Annotations | Insert | Inserts an annotation. | --- | |
| | Selected Annotation | Edit | Edits the selected annotation. | When an annotation is selected |
| | | Delete | Deletes the selected annotation. | |
| | | Bring to Front | Displays the selected annotation in front of other annotations. | |
| | | Send to Back | Displays the selected annotation behind other annotations. | |
| | | Send Behind Blocks and Lines | Makes the selected annotation transparent. | |
| | | Font Size | Changes the selected annotation's font size. | |
| Edit | Edit Block ITEMS | Displays ITEMS window. | When the cursor is positioned on a function block that has been pasted | |
| | Edit User Link Table | Edits a user link table. | When the cursor is positioned on a user link table that has been pasted | |
| | Edit Connection | Directly inputs ITEM data for the ITEM displayed in blue in Edit Block Diagram Mode. | When the cursor is on an ITEM displayed in blue | |
| Find Target Block | | When a block diagram has been specified, moves the cursor to the relevant block in the Project Workspace. | When the cursor is positioned on a function block that has been pasted | |
| Setting Operation Cycle | Common | Sets the execution cycle for all function blocks in a function block diagram. | --- | |
| | 0.01 sec | | | |
| | 0.02 sec | | | |
| | 0.05 sec | | | |
| | 0.1 sec | | | |
| | 0.2 sec | | | |
| | 0.5 sec | | | |
| | 1.0 sec | | | |
| | 2.0 sec | | | |
| Download | Downloads only the function blocks actually set above to the Loop Controller. | | | |
| Scale | Scale 100%, 200%, or 50% | Same as selecting 100% , 200% , or 50% from the Scale Menu. | --- | |
| Display Mode | Grid Mode | Same as selecting Grid Mode from the Select Mode Menu. | --- | |
| | Show CSV Tag Name | Same as selecting Show CSV Tag Name from the Select Mode Menu. | | |
| Undo | | Undos the last operation that was executed. | --- | |
| Connection Map | | Displays the I/O relationships for the function block that is selected. | When the cursor is positioned on a function block that has been pasted and connected | |
| Show Memory Map | | The status showing how the Loop Controller is using CPU Unit memory can be displayed as a list. | When an LCU or LCB element is selected | |
| Print Block Diagram | | Prints the open block diagrams. | --- | |
| Function Block Reference | | Displays the help reference for the selected function block. | When the cursor is positioned on a function block that has been pasted | |

Edit User Link Table Mode Menus**Pop-up Menu (Displayed by Right-clicking)**

| Pop-up menu command | | Description | Conditions for selection |
|----------------------|-------------------------|---|-------------------------------------|
| Add | | Adds a tag to the user link table. The User Link Table Edit Dialog Box will be displayed. | --- |
| Block Set | | Adds multiple tags to the user link table (adding serial numbers to the file name). | --- |
| Move | | Increases the entry numbers for the specified entry and all entries lower than it by an increment of 1. | When a line of tag data is selected |
| Arrange Number | | Reassigns all entry numbers in ascending order. (This is not a reordering function.) The reference for the related function blocks is also automatically changed by this operation. | When a line of tag data is selected |
| Edit | Selected | Edits the basic data in the user link table. | When a line of tag data is selected |
| | Extension | Edits the extension data in the user link table. | When a line of tag data is selected |
| Delete | Selected Entries | Edits the selected user link table tag. | When a line of tag data is selected |
| | No Connection | Deletes all tags from the user link table. | --- |
| | Delete Registered Entry | Deletes the CX-Process Tool entry and the entry stored in the LCB at the same time. | When a line of tag data is selected |
| Update Refresh Cycle | Selected Entries | Sets the refresh cycle for the tags selected in the user link table. | When a line of tag data is selected |
| | All Entries | Sets the refresh cycle for all tags in the user link table. | --- |
| Find | | Finds tags that match or contain the specified text. Perfect matches or considering case can be set before searching. | --- |
| Transfer to LC | Selected Entries | Downloads the selected tags in the user link table to the Loop Controller. | When a line of tag data is selected |
| | All Entries | Downloads all tags in the user link table to the Loop Controller. | --- |

| Pop-up menu command | | Description | Conditions for selection | |
|---------------------|----------------------|--|---|-----|
| Filter | Analog/ Contact | Analog | Displays analog signal tags. | --- |
| | | Contact | Displays contact signal tags. | |
| | | Both | Displays both analog and contact signal tags. | |
| | Read/Write | Read (from LCB) | Displays tags that read from the CPU Unit to the Loop Controller. | --- |
| | | Write (to LCB) | Displays tags that write from the Loop Controller to the CPU Unit. | |
| | | Read/Write | Displays tags that both read and write. | |
| | Memory Area | CIO | Displays tags allocated in the CIO Area of the CPU Unit. | --- |
| | | W | Displays tags allocated in the Work Area of the CPU Unit. | |
| | | H | Displays tags allocated in the Holding Area of the CPU Unit. | |
| | | DM | Displays tags allocated in the DM Area of the CPU Unit. | |
| | | EM | Displays tags allocated in the EM Area of the CPU Unit. | |
| | | All | Displays tags allocated in all of the areas in the CPU Unit. | |
| | Field Terminal | | Displays tags for field terminals. | --- |
| | Field Terminal Block | | Selected if a filter display is used for a user link table containing expansion settings. | --- |
| | CSV Tag | | Displays entries for CX-Process Monitor Plus. | --- |
| No Connection | | Turns OFF the display of all tags. | --- | |
| All Entries | | Displays all tags. | --- | |
| Connection Map | | Displays detailed information on the software links between two function blocks. | When a line of tag data is selected | |
| Print | | Prints the user link table. | --- | |

Edit Sequence Table Mode Menus

If a function block file in a sequence table is double-clicked to enter sequence table mode, the following menus will be displayed between the Operation Menu and the Window Menu.

Main Menus

| Menu | Command | | Description | |
|---------|-------------------|---|---|---|
| Scale | 100% | | Displays the sequence table at 100%. | |
| | 200% | | Displays the sequence table at 200%. | |
| | 50% | | Displays the sequence table at 50%. | |
| | Zoom In Alt+Right | | Increases the size of the sequence table display. | |
| | Zoom Out Alt+Left | | Decreases the size of the sequence table display. | |
| Edit | Signal Name | | Edits a signal. When a signal is selected in Edit Mode | |
| | Comment | | Edits a comment. When a comment is selected in Edit Mode | |
| | Logical Data | Yes | | Sets a value to Yes. When a value is selected in Edit Mode |
| | | No | | Sets a value to No. When a value is selected in Edit Mode |
| | Block Set | Yes | Sets an entire row or column to Yes. When a row or column is selected in Edit Mode | |
| | | No | Sets an entire row or column to No. When a row or column is selected in Edit Mode | |
| Element | | Edits an element when elements are displayed. When a row or column is selected in Edit Mode and elements are displayed | | |

| Menu | Command | | Description | |
|---------------------------|------------------------|---|---------------------------|--|
| Operation | Column/ Row | Insert Row | Inserts one signal row. | When a row (signal + value) is selected in Edit Mode |
| | | Delete Row | Deletes one signal row. | When a row (signal + value) is selected in Edit Mode |
| | | Insert Column | Inserts one rule column. | When a column (rule) is selected in Edit Mode |
| | | Delete Column | Deletes one rule column. | When a column (rule) is selected in Edit Mode |
| Edit Block Item | | Displays and edits a list of ITEMS for the function blocks that are the source and destination for the selected signal. | When a signal is selected | |
| Edit User Link Table | | Displays and edits user link table for the function blocks that are the source and destination for the selected signal. | When a signal is selected | |
| Show Connection Map | | Displays a connection map that visually represents the input source and output destination of the selected signal. | | |
| Find Sequence Table Block | | Moves the cursor to the function block that corresponds to the currently open sequence table in the Project Workspace. | --- | |
| Edit Mode | Enable | Enables editing a sequence table. | --- | |
| | Disable | Disables editing a sequence table. | | |
| Point Navigation | Enable | Displays intersection points. | --- | |
| Vertical Line | Show | Displays vertical lines. | --- | |
| View Mode | Table | Displays a sequence table. | --- | |
| | Element | Displays an element to enable editing it. | | |
| | All Elements | Displays all elements for each page. | | |
| Expand | Vertical | Expands the number of conditional operations in a sequence table. | Edit Mode | |
| | Horizontal | Expands the number of entries in a sequence table. | | |
| Reference Setting | Main Table | Sets the selected sequence table as the main table. | | |
| | Reference Table | Sets the selected sequence table as the reference table. | | |
| Execute Form | Every Cycle | Sets the sequence table to be executed every cycle. | | |
| | Start by S1 | Sets the sequence table to be started by S1. | | |
| | Start Only First Cycle | Sets the sequence table to be executed on the first cycle. | | |
| | Not Execute | Set the sequence table so that it's not started. | | |
| Undo | | Undoes the previous operation. | | --- |
| Check Errors | | Checks for errors in the sequence table that has been entered. | | --- |
| Print | General | Prints the sequence table normally. | --- | |
| | Separated | Prints the sequence table in sections. | --- | |

| Menu | Command | | Description | |
|-----------------|-------------|----------------|--|-----------------------------------|
| Validate Action | Start | | Starts validation of the sequence table. | When online |
| | Stop | | Stops validation of the sequence table. | When a table is being validated |
| | Online Edit | Start | Starts editing the sequence table. | When operation is being validated |
| | | Stop | Stops editing the sequence table. | During editing |
| | | Transfer to LC | Downloads the edited sequence table. | When operation is being validated |

Pop-up Menu (Displayed by Right-clicking)

| Pop-up menu command | | | Description | Conditions for selection | |
|-----------------------------|---------------|--|---|--|--|
| Edit Mode | Enable | | Enables editing a sequence table. | --- | |
| | Disable | | Disables editing a sequence table. | | |
| View Mode | Table | | Displays a sequence table. | --- | |
| | Element | | Displays an element to enable editing it. | | |
| | All Elements | Page 1 (No. 000 – No. 099) | | | Displays all elements for each page. |
| | | Page 2 (No. 100 – No. 199) | | | |
| Page 10 (No. 900 – No. 999) | | | | | |
| Cut | | | Cuts one or more signal rows. | When one or more rows (signal + value) are selected in Edit Mode | |
| Copy | | | Copies one or more signal rows. | When one or more rows (signal + value) are selected in Edit Mode | |
| Paste | | | Pastes one or more signal rows. | When one or more rows have been cut or copied | |
| Column/ Row | Insert Row | | Inserts one signal row. | When a row (signal + value) is selected in Edit Mode | |
| | Delete Row | | Deleted one signal row. | When a row (signal + value) is selected in Edit Mode | |
| | Insert Column | | Inserts one rule column. | When a column (rule) is selected in Edit Mode | |
| | Delete Column | | Deletes on rule column. | When a column (rule) is selected in Edit Mode | |
| Data Edit | Signal Name | | Edits a signal. | When a signal is selected in Edit Mode | |
| | Comment | | Edits a comment. | When a comment is selected in Edit Mode | |
| | Logical Data | Yes | | Sets a value to Yes. | When a value is selected in Edit Mode. |
| | | No | | Sets a value to No. | |
| | Block Set | Yes | Sets an entire row or column to Yes. | | When a row or column is selected in Edit Mode. |
| | | No | Sets an entire row or column to No. | | |
| Element | | Edits an element when elements are displayed | | When a row or column is selected in Edit Mode and elements are displayed | |
| Delete | | | Deletes a value or tag name. | --- | |

| Pop-up menu command | | Description | Conditions for selection | |
|---------------------------|------------------------|---|---|--|
| Validate Action | Start | | Starts validation of the sequence table. | |
| | Stop | | Stops validation of the sequence table. | |
| | Edit | Start | Starts editing the sequence table. | |
| | | Stop | Stops editing the sequence table. | |
| | | Transfer to LC | Downloads the edited sequence table. | |
| | | | (Only when online.) | |
| | | | When a table is being validated | |
| | | | (Only when a table is being validated.) | |
| | | | When a table is being edited. | |
| | | | (Only when a table is being validated.) | |
| Expand | Vertical | Expands the number of conditional operations in a sequence table. | Edit Mode | |
| | Horizontal | Expands the number of rules in a sequence table. | | |
| Reference Setting | Main Table | Sets the selected sequence table as the main table. | | |
| | Reference Table | Sets the selected sequence table as the reference table. | | |
| Execute Form | Every Cycle | Sets the sequence table to be executed every cycle. | | |
| | Start by S1 | Sets the sequence table to be started by S1. | | |
| | Start Only First Cycle | Sets the sequence table to be executed on the first cycle. | | |
| | Not Execute | Set the sequence table so that it's not started. | | |
| View Options | Point Navigation | Enable | Displays intersection points. | --- |
| | Vertical Line | Show | Displays vertical lines. | --- |
| Edit | Edit Block Item | | Displays and edits a list of ITEMS for the function blocks that are the source and destination for the selected signal. | When a signal is selected |
| | User Link Table | | Displays and edits user link table for the function blocks that are the source and destination for the selected signal. | When a signal is selected |
| Find Sequence Table Block | | | Moves the cursor to the function block that corresponds to the currently open sequence table in the Project Workspace. | --- |
| Scale | 100% | | Displays the connection diagram at 100%. | --- |
| | 200% | | Displays the connection diagram at 200%. | |
| | 50% | | Displays the connection diagram at 50%. | |
| | Zoom In, Alt + Right | Increases the size of the connection diagram display. | | |
| | Zoom Out, Alt + Left | Decreases the size of the connection diagram display. | | |
| Check Errors | | | Checks for errors in the sequence table that has been entered. | --- |
| Undo | | | Undoes the previous operation. | --- |
| Connection Map | | | Displays a connection map that visually represents the input source and output destination of the selected signal. | When a signal is selected |
| Show Memory Map | | | The status showing how the Loop Controller is using CPU Unit memory can be displayed as a list. | When an LCU or LCB element is selected |
| Print | General | | Prints the sequence table normally. | --- |
| | Separated | | Prints the sequence table in sections. | --- |

Menus in Edit Step Ladder Program Mode

Select a step ladder program block (model block 301) first, and then select **Edit - Step Ladder Program** from the Settings Menu so that the CX-Process Tool will enter Edit Step Ladder Program Mode, where the following menus will appear to the right of the Execution Menu.

| Menu | Instruction | Description | |
|-------------------|--------------------------------------|---|---|
| Scale | 100% | Displays the ladder diagram at 100%. | |
| | 200% | Displays the ladder diagram at 200% | |
| | 50% | Displays the ladder diagram at 50% | |
| | Zoom In | Increases the size of the ladder diagram display. | |
| | Zoom Out | Decreases the size of the ladder diagram display. | |
| Change Mode | Select | Returns the cursor to the normal selection condition. | |
| | Draw Line | Draws a line. | |
| | Delete Line | Deletes a line. | |
| | LOAD | Inputs a LD instruction. | |
| | LOAD NOT | Inputs a LD NOT instruction. | |
| | OUT | Inputs an OUT instruction. | |
| | OUT NOT | Inputs an OUT NOT instruction. | |
| | SET | Inputs a SET instruction. | |
| | RESET | Inputs a RESET instruction. | |
| | TIM | Inputs a TIM instruction. | |
| | DIFU | Inputs a DIFU instruction. | |
| | DIFD | Inputs a DIFD instruction. | |
| | STEP | Inputs a STEP instruction | |
| | BLOCK SET | Inputs a BLOCK SET instruction. | |
| | BLOCK RESET | Inputs a BLOCK RESET instruction. | |
| | JUMP | Inputs a JUMP instruction. | |
| | STEP TIMER | Inputs a STEP TIMER instruction. | |
| | ALARM TIMER | Inputs an ALARM TIMER instruction. | |
| | Annotations | Inserts annotation. | |
| View ITEM Name | Displays data for the selected ITEM. | | |
| Manipulate Ladder | Mnemonics | Opens the Mnemonic Input screen. | |
| | Convert Ladder to Mnemonics | Converts a step ladder program into mnemonics. | |
| | Convert Mnemonics to Ladder | Converts a step ladder program written with mnemonics or converts uploaded mnemonics into a ladder diagram. | |
| | Insert Row | Inserts a row before the row where the cursor is located. | |
| | Delete Row | Deletes the row where the cursor is located. | |
| | Invert (NOT) | Inverts the selected operation. (NO condition ↔ NC condition, SET ↔ RESET, OUT ↔ OUT NOT, BSET ↔ BRSET, and Up-differentiated ↔ Down-differentiated) | |
| | Selected Annotation | Edit | Edits the selected annotation. |
| | | Bring to Front | Displays the selected annotation in front of other annotations. |
| | | Send to Back | Displays the selected annotation behind other annotations. |
| | | Send Behind Symbols and Lines | Makes the selected annotation transparent. |
| | | Font Size | Changes the selected annotation's font size. |
| Undo | | Reverses (undoes) the last operation. | |

| Menu | Instruction | Description |
|-----------------|-------------|--|
| Validate Action | Start | Starts checking the operation of the ladder diagram. |
| | Stop | Ends checking the operation of the ladder diagram. |

Pop-up Menu (Menu Displayed by Clicking Right Button)

| Pop-up menu command | | Description | Conditions for selection | |
|---------------------|-----------------------------------|--|--|-----|
| Data Configuration | | Inputs an operand. | When an instruction symbol is selected | |
| Edit Mode | Select Cell | Set the cursor to normal selection status. | --- | |
| | Draw Line | Sets line connection mode. | --- | |
| | Delete Line | Sets line deletion mode. | --- | |
| | Symbols | LOAD | Inputs a condition. | --- |
| | | LOAD NOT | Inputs a NOT condition. | |
| | | OUT | Inputs an output. | |
| | | OUT NOT | Inputs a NOT output. | |
| | | SET | Inputs a SET instruction. | |
| | | RESET | Inputs a RESET instruction. | |
| | | ON DIFF | Inputs an upward differentiation instruction. | |
| | | OFF DIFF | Inputs a downward differentiation instruction. | |
| | | STEP Declaration | Inputs a STEP declaration. | |
| | | BLOCK SET | Inputs a BLOCK SET instruction. | |
| | | BLOCK RESET | Inputs a BLOCK RESET instruction. | |
| JUMP | | Inputs a JUMP instruction. | | |
| STEP TIMER | | Inputs a STEP TIMER instruction. | | |
| ALARM TIMER | Inputs a ALARM TIMER instruction. | | | |
| Annotation | Inputs a comment. | | | |
| Selected Annotation | Edit | Same as selecting Selected Annotation/Edit from the Manipulate Ladder Menu. | When an annotation is selected | |
| | Bring to Front | Displays the selected annotation in front of other annotations. | | |
| | Send to Back | Displays the selected annotation behind other annotations. | | |
| | Send Behind Symbols and Lines | Makes the selected annotation transparent. | | |
| | Font Size | Changes the selected annotation's font size. | | |
| Cut | | Cuts a selected symbol, area, or line and places it in the special copy buffer for CS-Process Tool (i.e., not on the clipboard). | When a symbol, area, or row is selected | |
| Copy | | Copies a selected symbol, area, or line and places it in the special copy buffer for CS-Process Tool (i.e., not on the clipboard). | When a symbol, area, or row is selected | |
| Paste | | Pastes the symbol, area, or line from the special copy buffer for CS-Process Tool (i.e., not from the clipboard). | When an area that can be pasted to is selected | |

| Pop-up menu command | | Description | Conditions for selection |
|----------------------|--------------------------|--|--|
| Delete | | Deletes an instruction. | When an instruction symbol is selected |
| Invert | | Same as selecting Invert (NOT) from the Manipulate Ladder Menu. | When a reversible symbol is selected |
| Insert Row | | Same as selecting Insert Row from the Manipulate Ladder Menu. | --- |
| Delete Row | | Same as selecting Delete Row from the Manipulate Ladder Menu. | --- |
| Validate Action | Start | Starts checking the operation of open ladder diagrams. | --- |
| | Stop | Stops checking the operation of open ladder diagrams. | --- |
| Edit | Edit Function Block ITEM | Displays the list of ITEMS window for the open step ladder blocks. | --- |
| | User Link Table | Same as Settings/User Link Table . | --- |
| Find Target Block | | When a ladder diagram has been specified and is being executed, moves the cursor to the relevant step ladder block in Project Workspace. | --- |
| Scale | | Select 100%, 200%, or 50% to display the diagram at 100%, 200%, or 50%. Press the Alt Key and the Left/Right Arrow Key to enlarge/reduce the diagram. | --- |
| Undo | | Same as selecting Undo from the Manipulate Ladder Menu. | After executing an operation |
| Connection Map | | Displays a connection map that visually represents the input source and output destination of the selected signal. | When an LCU or LCB element is selected |
| Show Memory Map | | The status showing how the Loop Controller is using CPU Unit memory can be displayed as a list. | When an LCU or LCB element is selected |
| Print Ladder Diagram | | Prints the open ladder diagrams. | --- |

Pop-up Project Workspace Menu (Menu Displayed by Clicking Right Button)

| Pop-up menu command | Description | Conditions for selection |
|------------------------------|--|------------------------------------|
| Initialize Workspace Display | Restores the Project Workspace display to its initial value (i.e., the display up to the function block file). | When Project Workspace is selected |

Pop-up Menu in Output Window (Menu Displayed by Clicking Right Button)

| Pop-up menu command | Description | Conditions for selection |
|---------------------|--|-------------------------------------|
| Copy All (Ctrl+C) | Copies to the clipboard the contents displayed in the Output Window. | When the Output Window is selected. |
| Clear | Clears the contents displayed in the Output Window. | |

Pop-up Monitor Tag List Menu (Menu Displayed by Clicking Right Button)

| Pop-up menu command | Description | Conditions for selection |
|----------------------------|---|--|
| Monitor Tag Setting | Displays the Monitor Tag Setting Dialog Box. | When the monitor tag list is displayed |
| Monitor Tag ITEM List | Displays the ITEM list for the send block to the relevant computer (to all nodes) (find Project Workspace). | |
| Registered Block ITEM List | Displays the ITEM list for the relevant source function block (find Project Workspace). | |
| Print | Prints the monitor tag list. | |

Pop-up Monitor Plus Tag List Menu (Menu Displayed by Clicking Right Button)

| Pop-up menu command | | | Description | Conditions for selection |
|----------------------------|---------------------|---------------------|---|---|
| Register | | | Registers tags for the CX-Process Monitor Plus. | When the monitor plus tag list is displayed |
| Edit | | | Used to edit Monitor Plus tags. | |
| Delete | | | Deletes Monitor Plus tags. | |
| ITEM List | | | Displays the ITEM list for the applicable function block (Project Workspace search). | |
| User Link Table | | | Displays the User Link Table Edit Window. | |
| Connection Map | | | Displays a connection map visually showing the input source and output target for selected signals. | |
| Check Overlapping Tag Name | | | Checks for Monitor Plus tags that are used more than once. | |
| Find Tag | | | Searches for the specified Monitor Plus tag name. | |
| Filter | Classifi- cation | Function Block | Displays only tags set in function blocks. | |
| | | User Link Table | Displays only tags set in user link tables. | |
| | | Both | Displays tags set in function blocks and user link tables. | |
| | Analog/ Contacts | Analog | Displays tags for analog signals. | |
| | | Contact | Displays tags for contact signals. | |
| | | Analog/ Contacts | Displays tags for analog signals and contact signals. | |
| | R/W | Read from LCB | Displays tags that read from the CPU Unit to the Loop Controller. | |
| | | Write to LCB | Displays tags that write from the Loop Controller to the CPU Unit. | |
| | | Read and Write | Displays both read and write tags. | |
| | Alarm Contact | | | Displays only tags set in alarm tags. |
| All Entries | | | Displays all Monitor Plus tags. | |
| Print | | | Prints Monitor Plus tags. | |

Pop-up Menu on CSV Tag List (Menu Displayed by Clicking Right Button)

| Pop-up menu command | Description | Conditions for selection |
|------------------------|--|----------------------------------|
| Edit | Edits the CSV tag list to reset CSV tags. | When a CSV tag list is displayed |
| Delete | Deletes CSV tag settings. | |
| Find | Finds a specified CSV tag name. | |
| List ITEMS | Displays a list of function block ITEMS for which the specified CSV tags are set. | |
| Connection Map | Displays the connection map for the function block for which the specified CSV tags are set. | |
| Check overlapping tags | Checks for CSV tag names that have been used twice. | |
| Print | Prints the CSV tag list. | |

Pop-up Cross-reference Menu (Menu Displayed by Clicking Right Button)

| Pop-up menu command | Description | Conditions for selection |
|-----------------------|-----------------------------------|-----------------------------------|
| Print Cross-reference | Prints the open cross-references. | When cross-reference is displayed |

Pop-up Menu on Connection Map

| Pop-up menu command | | Description | Conditions for selection | |
|--------------------------|----------------------|--|---|---|
| Back | | Returns to the previously display function block connection map. | --- | |
| Forward | | Returns to the connection map displayed before Back was executed. | --- | |
| Jump | Selected Item | Selects an ITEM in the connection map. | When the function block for which the connection map was display is selected | |
| | Memory Area | Optional | Displays a connection map for a specified CPU Unit I/O memory area (CIO, W, H, DM, or EM0) and address. | |
| | | Increment | Increments the displayed address by one word. | When an I/O memory address for the connection map is selected |
| | | Decrement | Decrements the displayed address by one word. | |
| Edit Function Block Item | | Displays a window showing a list of function block ITEMS. | --- | |
| Edit Block Diagram | | Display a function block diagram window. | When an ITEM in the function block for which the connection map was display is selected | |
| Edit Step Ladder Diagram | | Display a connection map for a step ladder program. | When a step ladder command is selected | |
| Edit User Link Table | | Displays a user link table window. | When a tag for a user link table is selected | |
| Edit Sequence Table | | Displays the Sequence Table Window. | When the sequence table symbol is selected | |
| Set Tags | | Displays the Function Block CSV Tag Setting Dialog Box for the displayed connection map. | When an CSV tag setting is selected | |
| Update Display | | Updates the connection map display. | --- | |
| Scale | 100% | Displays the connection diagram at 100%. | --- | |
| | 200% | Displays the connection diagram at 200%. | | |
| | 50% | Displays the connection diagram at 50%. | | |
| | Zoom In, Alt + Right | Increases the size of the connection diagram display. | | |
| | Zoom Out, Alt + Left | Decreases the size of the connection diagram display. | | |
| Print | | Prints the connection map. | --- | |

SECTION 3

Creating Function Blocks

This section describes how to create and manipulate function blocks.

| | | |
|--------|---|-----|
| 3-1 | Creating Function Block | 99 |
| 3-1-1 | Data Configuration | 99 |
| 3-1-2 | Starting the CX-Process Tool | 100 |
| 3-1-3 | Creating a New Project | 103 |
| 3-1-4 | Types of Function Blocks | 105 |
| 3-1-5 | Making System Common Block Initial Settings | 106 |
| 3-1-6 | Registering Function Blocks | 108 |
| 3-1-7 | Editing Function Blocks | 110 |
| 3-1-8 | Editing Block Diagrams | 111 |
| 3-1-9 | Editing ITEMS in Function Blocks | 124 |
| 3-1-10 | Saving the Project Workspace | 128 |
| 3-1-11 | Opening a Project Workspace | 128 |
| 3-1-12 | Editing Projects | 129 |
| 3-2 | Using the CX-Process Monitor | 132 |
| 3-2-1 | Setting and Compiling Monitor Tags for CX-Process Monitor | 132 |
| 3-2-2 | Validate the Monitor Tag List | 136 |
| 3-3 | Using the CX-Process Monitor Plus | 138 |
| 3-4 | Using SCADA Software | 141 |
| 3-4-1 | Creating SCADA Software and RS View Tag Files | 141 |
| 3-4-2 | CSV Output Function for HMI Data Allocation Status | 157 |
| 3-4-3 | Other Interfaces with HMI | 157 |
| 3-5 | User Link Tables | 159 |
| 3-5-1 | Overview | 159 |
| 3-5-2 | Creating User Link Tables | 160 |
| 3-5-3 | Importing CX-Programmer Symbols into a User Link Table | 165 |
| 3-5-4 | Editing User Link Tables | 167 |
| 3-6 | Creating User-defined Blocks | 173 |
| 3-6-1 | Overview | 173 |
| 3-6-2 | How User-defined Blocks Work | 173 |
| 3-6-3 | Creating User-defined Blocks on the CX-Process Tool | 175 |
| 3-6-4 | Inserting User-defined Blocks | 177 |
| 3-6-5 | Exporting User-defined Blocks to Files | 178 |
| 3-6-6 | Importing User-defined Blocks from Files | 179 |
| 3-7 | Creating Step Ladder Program Instructions | 180 |
| 3-7-1 | Ladder Diagrams | 180 |
| 3-7-2 | Mnemonics | 187 |
| 3-7-3 | Cross-reference Display | 190 |
| 3-7-4 | Step Ladder Instructions | 191 |
| 3-7-5 | Other Icons | 194 |
| 3-8 | Creating Sequence Tables | 195 |
| 3-8-1 | Creating a Sequence Table | 195 |
| 3-8-2 | Names of Sequence Table Elements | 197 |
| 3-8-3 | Setting Execution Forms | 197 |
| 3-8-4 | Zooming In and Out of a Sequence Table | 197 |
| 3-8-5 | Editing Sequence Tables | 198 |
| 3-8-6 | Settings for Conditions and Actions | 199 |
| 3-8-7 | Editing Elements | 202 |
| 3-8-8 | Expanding the Sequence Table | 203 |
| 3-8-9 | Table References for LCB05 Ver. 3.0 or Later | 204 |
| 3-8-10 | Checking for Errors in the Sequence Table | 205 |
| 3-8-11 | Validating the Actions of the Sequence Table | 206 |
| 3-8-12 | Printing the Sequence Table | 206 |

| | | |
|---------|--|-----|
| 3-9 | Displaying and Setting in Engineering Units | 207 |
| 3-9-1 | Overview | 207 |
| 3-9-2 | Functions for Which Engineering Unit Displays and Settings Are Enabled | 208 |
| 3-9-3 | Setting CSV Tags for Function Blocks | 208 |
| 3-9-4 | Setting Projects in Engineering Unit Mode | 208 |
| 3-9-5 | Displaying Function Block ITEM Lists | 209 |
| 3-9-6 | Editing Function Block ITEMS | 209 |
| 3-9-7 | Displaying Engineering Units When Confirming Operation | 210 |
| 3-9-8 | Related Functions | 210 |
| 3-10 | Displaying Loop Controller Memory Maps | 212 |
| 3-10-1 | Overview | 212 |
| 3-10-2 | Operation Procedure | 213 |
| 3-10-3 | Screens | 213 |
| 3-11 | Printing | 216 |
| 3-11-1 | Printable Data | 216 |
| 3-11-2 | Printing Function Blocks | 217 |
| 3-11-3 | Printing Block Diagrams | 218 |
| 3-11-4 | Printing Ladder Diagrams | 220 |
| 3-11-5 | Printing Cross-references | 220 |
| 3-11-6 | Printing Monitor Tag Lists (Loop Control Units Only) | 221 |
| 3-11-7 | Printing CSV Tag Lists | 222 |
| 3-11-8 | Printing All | 222 |
| 3-11-9 | Printing ITEM Lists | 222 |
| 3-11-10 | Printing Sequence Tables | 222 |
| 3-11-11 | Printing User Link Tables | 223 |
| 3-11-12 | Printing Connection Maps | 223 |
| 3-12 | Setting Options | 224 |
| 3-12-1 | Overview | 224 |
| 3-12-2 | General Tab Page | 226 |
| 3-12-3 | Communication Tab Page | 228 |
| 3-12-4 | CSV Tag Setting Tab Page | 228 |
| 3-12-5 | Function Block Diagram Tab Page | 230 |
| 3-12-6 | Step Ladder Tab Page | 231 |
| 3-12-7 | Sequence Table Tab Page | 231 |
| 3-12-8 | User Link Tab Page | 232 |
| 3-12-9 | Connection Map Tab Page | 233 |

3-1 Creating Function Block

3-1-1 Data Configuration

This section describes the function block data created using the CX-Process Tool.

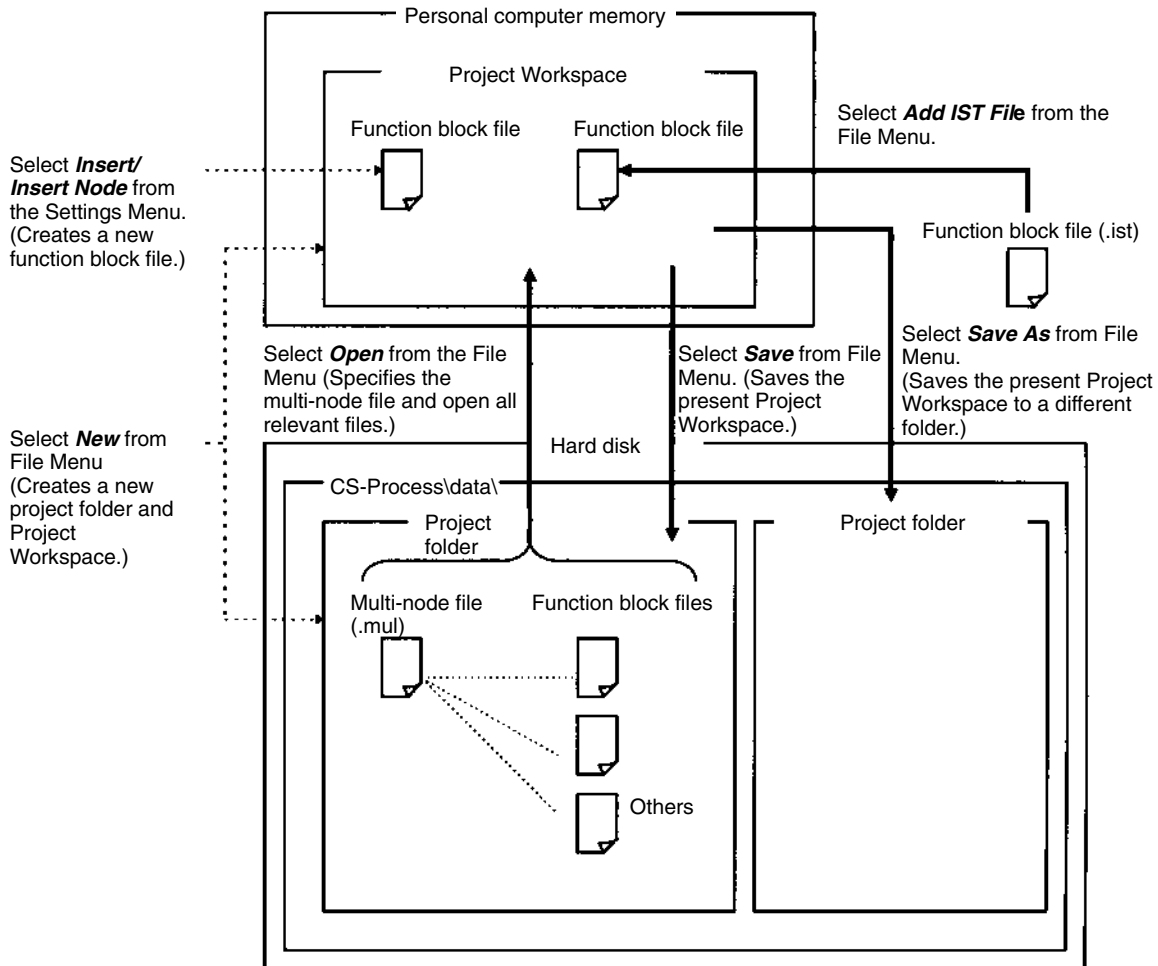

Select **Insert/Insert Node** from the Settings Menu. (Creates a new function block file.)

Select **New** from File Menu (Creates a new project folder and Project Workspace.)

Select **Open** from the File Menu (Specifies the multi-node file and open all relevant files.)

Select **Save** from File Menu. (Saves the present Project Workspace.)

Select **Add IST File** from the File Menu.

Select **Save As** from File Menu. (Saves the present Project Workspace to a different folder.)

When creating a new Project Workspace, specify the folder (project folder) where the Project Workspace will be saved. (Select **New** from the File Menu.)

Save all the Project Workspace data in the project folder in the memory of the personal computer. (Select **Save** from the File Menu.)

To prepare a function block file (.ist) in the Project Workspace, insert a node. (Select **Insert – Insert Node** from the Settings Menu.)

To open all the existing data in Project Workspace, specify only the multi-node file (.mul) in the project folder. All relative files will be read. (Select **Open** from File Menu.)

To save all the data in Project Workspace in a different project folder, select **Save As** from the File Menu.

To import a function block file (.ist) into the Project Workspace, add a function block file. (Select **Add IST File** from File Menu.)

3-1-2 Starting the CX-Process Tool

Use one of the following methods to start the CX-Process Tool.

- Starting from the Windows Start Menu
- Starting from the CX-Programmer I/O tables (This method can be used when the CX-Process Tool has been installed from CX-One.)

Starting the CX-Process Tool from the Start Menu

- 1, 2, 3...**
1. Select **OMRON – CX-One – CX-Process Tool – CX-Process Tool** from the Windows Start Menu.
 2. Select the communications driver that will be used (FinsGateway or CX-Server) and click the **OK** button.

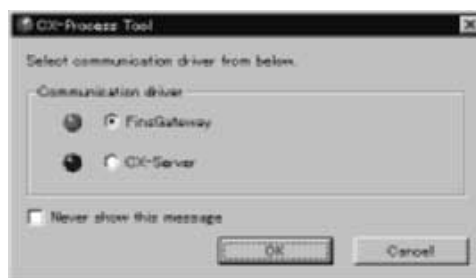

- Note**
1. For details on selecting the communications driver, refer to *1-6-2 Selecting the Communications Driver*.
 2. If the CX-Process Tool has been installed from CX-One, CX-Server will be automatically set as the communications driver by default. To change the communications driver to FinsGateway, first start the CX-Process Tool with the CX-Server as the communications driver. Then select **Select Communications Driver to Start - Display** from the File Menu. Restart the CX-Process Tool and select FinsGateway from the above dialog box.
 3. For details on changing the communications driver when creating a project, refer to *3-1-12 Editing Projects*.

Starting the CX-Process Tool from the I/O Tables

The CX-Process Tool can be started from the I/O tables when the CX-Process Tool has been installed together with the CX-Programmer from the CX-One. Starting from the I/O tables provides the following advantages:

- The I/O tables can be controlled as a single PLC System.
- The communications settings made with the CX-Programmer can be inherited, so there is no need to make the settings again for the CX-Process Tool.

Note With this start method, CX-Server is automatically used as the communications driver.

- 1, 2, 3...**
1. Right-click the Loop Control Board or Unit in the I/O Table Window opened from the CX-Programmer that was installed from the CX-One, and select **Start Special Application – Start with Settings Inherited**.

| CX-Programmer PLC type setting | | Name in Unit Selection Dialog Box in I/O Table Window | Loop Control Board or Loop Control Unit |
|--------------------------------|----------------|---|---|
| PLC type | CPU Unit model | | |
| CJ1G-H | CPU42 | Loop Controller | CJ1W-LCB01 (Loop Control Board) |
| | CPU43/44/45 | | CJ1W-LCB03 (Loop Control Board) |
| CS1G-H, CS1H-H | CPU□□ | | CS1W-LCB01 (Loop Control Board) |
| | | | CS1W-LCB05 (Loop Control Board) |
| CS1H-H | CPU65/67 | | CS1D-LCB05D (Loop Control Board) |
| CS1G-H, CS1H-H, CS1G, CS1H | CPU□□ | | CS1W-LC001 (Loop Control Unit) |

Example: Right-click the Loop Control Board (e.g., CS1W-LCB05).

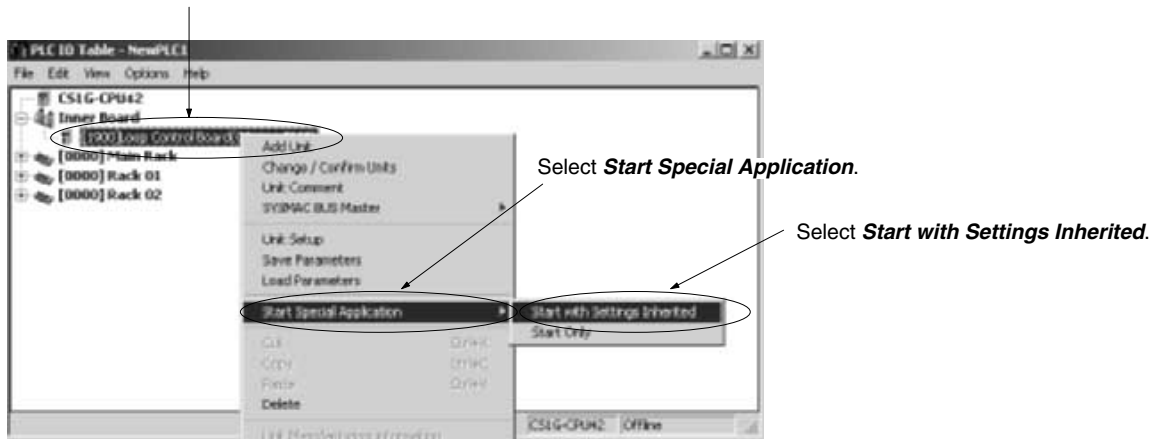

2. CX-Process Tool will start and at the same time, the Function Block File for the node will be inserted (**Settings – Insert – Insert Node**). At this time, the following dialog box will be displayed. The Number-Model setting (e.g., 00-LCB05) will be automatically selected, based on the Loop Control Board/Unit model in the original I/O Table Window.

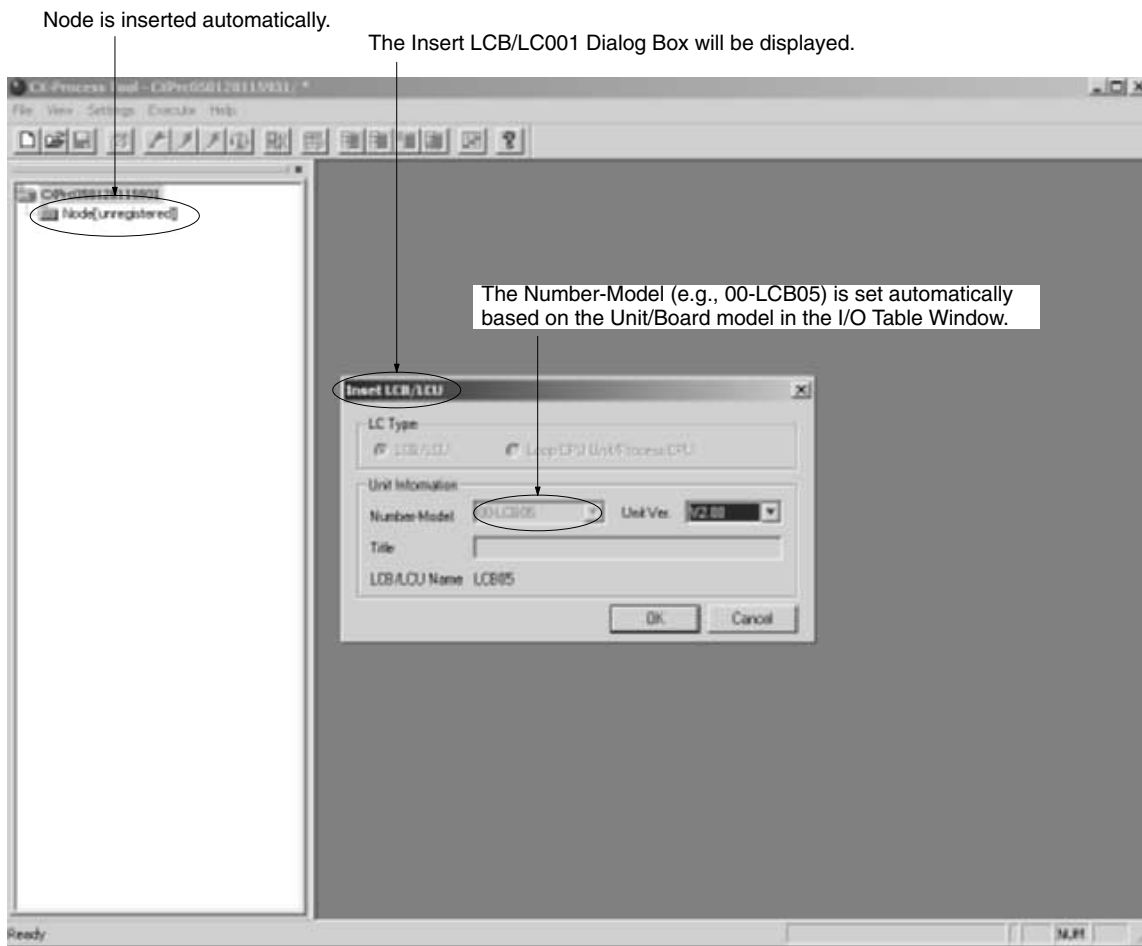

When the CX-Process Tool is started by selecting **Start with Settings Inherited**, the procedure up until the inserting the node's Function Block File is performed automatically.

The project name is automatically created as follows:

Name: CXPr + Year, month, day, hour, minute, and second that CX-Process Tool was started (Example: CXPr050207142030 when started 2005, February 7 at 14:20:30.)

The folder in which the automatically-created project is saved will be the same folder in which the CX-Programmer project is saved. If no CX-Programmer project has been saved, then "Desktop" will be selected.

Note When starting from the I/O tables, it is possible to select *Start Only* so that the communications settings are not inherited. In that case, the starting method is the same as when starting from the Windows Start Menu.

3-1-3 Creating a New Project

- 1, 2, 3... 1. Select **New** from the File Menu.

The following Browse for Folder Dialog Box will be displayed. Select the location for saving the project folder.



2. The following dialog box will be displayed.



Enter the project name, and click the **OK** Button.

The new Project Workspace and a project folder with the project name will be created. The project name set in the New Project Name Dialog Box will appear as the Project Workspace name on the right of the top folder on the Project Workspace Window. The name will appear in the title bar as well.

- Note**
- (1) The selection of **New** from the File menu does not just create new Project Workspace but also creates a new project folder.
 - (2) If a project of the same name already exists, a dialog box will appear with a message stating the existence of the specified project folder name and you will be asked if the operation should be aborted.
 - (3) The following dialog box will appear.

Select the LCU/LCB number, input the title (name) of the LCU/LCB element, and click the **OK** Button. The LCU/LCB element will contain the data for a single Loop Controller. The default name, (LC Type: LCB/LCU, Number-Model: LCB05), will appear. The title (name) of the LCU/LCB element can be input within 26 characters.



Note If LCB Unit version 3.00 or later is selected, it will not be possible to convert the data for use with LCB Unit version 2.00 or earlier as described later. Confirm the LCB version before creating an LCB.

The following table lists the LCU/LCB numbers and corresponding Loop Controllers.

| Loop Controller type | LCU/LCB number | Unit version | Model |
|---------------------------|-----------------|-----------------------|-----------------|
| Loop Control Boards (LCB) | 00-LCB01 | Version 1.00 or later | CS1W-LCB01 |
| | 00-LCB05 | Version 1.00 or later | CS1W-LCB05 |
| | 00-LCB05-GTC | Version 3.00 | CS1W-LCB05-GTC |
| Loop Control Unit (LCU) | 01-LC001 | --- | CS1W-LC001 |
| | 02-LC001 | | |
| | 03-LC001 | | |
| Process-control CPU Unit | 00-LCB05D | Version 1.00 | CS1D-CPU□□P |
| Loop-Control CPU Unit | CJ1G-CPU42P | Version 2.00 or later | CJ1G-CPU42P |
| | CJ1G-CPU43P | Version 2.00 or later | CJ1G-CPU43P |
| | CJ1G-CPU44P | Version 2.00 or later | CJ1G-CPU44P |
| | CJ1G-CPU45P | Version 2.00 or later | CJ1G-CPU45P |
| | CJ1G-CPU45P-GTC | Version 3.00 | CJ1G-CPU45P-GTC |

- Note**
- a) One Loop Control Board, one Loop-control CPU Unit, and three Loop Control Units can be registered per node.
 - b) A Loop Control Board can be registered and used at the same time as a Loop Control Unit.
 - c) A Loop-control CPU Unit cannot be registered at the same time as a Loop Control Board at the same node.
 - d) Always set the version that corresponds to the Loop Controller being used. If the incorrect version is set by mistake, use **Change LC Type** from the Execute Menu to change the version number. For details on methods used to confirm the Loop Controller version, refer to *Unit Version Notation on Products* on page viii.

3. The project tree will be displayed in the Project Workspace.
 - The node name will be automatically registered as “Node” + the node number (0 to 32). (See note.)
 - The Block Diagram 1 function block group will be selected (highlighted) in the project tree.
 - The Block Diagram 1 function block group will be opened.

Note Up to 32 nodes can be registered (01 to 32 when FinsGateway is used as the communications driver, and 00 to 31 when CX-Server is used).

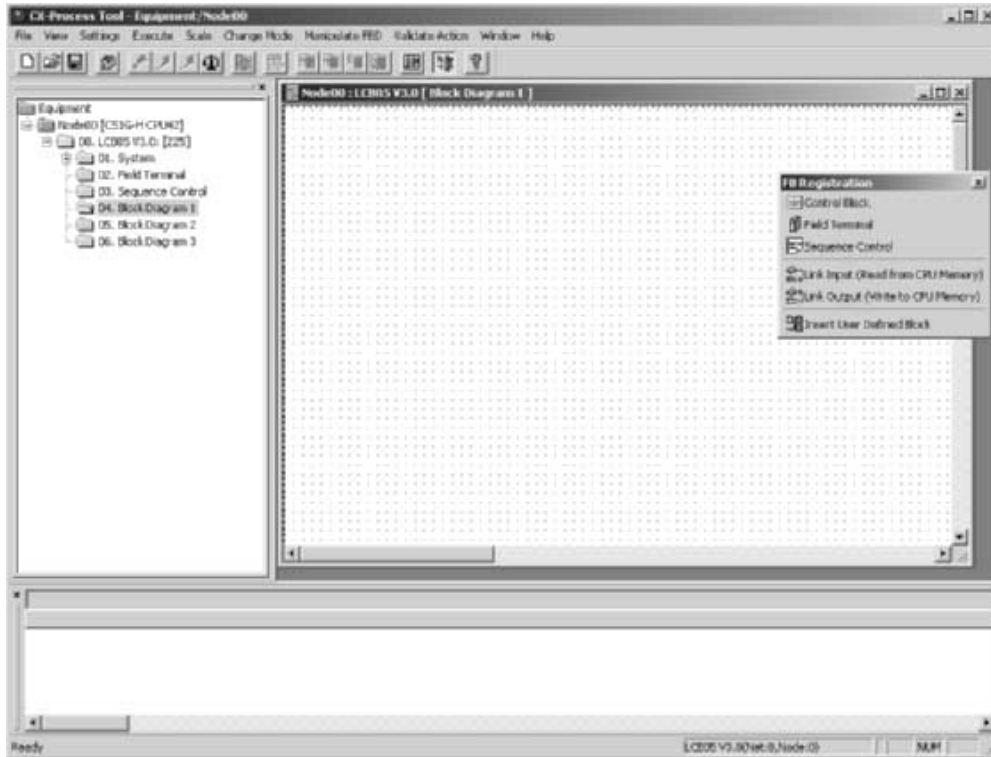

3-1-4 Types of Function Blocks

The function blocks to be used are registered in the Project Workspace and are assigned block numbers. Function blocks are grouped by type in function block groups in the Project Workspace tree. Select function block groups according to the application, and register the function blocks. The types of function blocks are described below.

System Common Block

The System Common Blocks is used to make common settings for Loop Controllers. There is one System Common Block registered for each Unit, and it cannot be deleted from the Workspace tree.

Control Blocks

Control Blocks are used to control the operation of Loop Controllers. They can be registered in the Block Diagram function block groups.

Field Terminal Blocks

Field Terminal Blocks are used to exchange data with I/O Units mounted to the PLC. They can be registered in the Field Terminal function block group.

Note Data is not exchanged with CX-Programmer I/O tables. Even when starting the CX-Process Tool with inherited settings, parameter information set in the I/O tables will not be inherited by ITEMS in Field Terminal Blocks.

Sequence Control Blocks

Sequence Control Blocks are used for sequence control in Loop Controllers. Step ladder programs and sequence tables are used. Sequence Control Blocks can be registered in the Sequence Control function block group. For details, refer to 3-8 *Creating Sequence Tables*.

User Link Table Blocks

User Link Tables link Loop Controllers and PLC memory. They can be registered as function blocks only in block diagrams. For details, refer to 3-5 *User Link Tables*.

User-defined Blocks

A combination of function blocks grouped by the user is called a User-defined Block. User-defined Blocks can be registered only in block diagrams. For details, refer to 3-6 *Creating User-defined Blocks*.

Note The folder items (function block groups) are as shown below for Loop Control Boards and Loop Control Units.

The Project Workspace Screen has the following function block group items for a Loop Control Unit.

| Function block groups on Project Workspace Screen | Block type | Block models | |
|--|-------------------------------------|--|------------|
| LCB□□ | 01. System Common | System Common | 000 |
| | 02. Field Terminal | Field Terminals | 501 to 587 |
| | 03. Sequence Control | Sequence Table | 302 |
| | | Step Ladder Program | 301 |
| | 04. Block Diagrams 1 to 3 | Control and Operation Blocks | 001 to 230 |
| External Controller Blocks | | 045 | |
| Loop Control Unit | 01. System Common | System Common | 000 |
| | 02. Field Terminal | Field Terminals | 501 to 587 |
| | 03. Send Terminal to All Nodes | Send Terminals to All Nodes | 407 to 410 |
| | 04. Receive Terminal from All Nodes | Receive Terminals from All Nodes | 414 to 415 |
| | 05. Send Terminal to Computer | Send Terminals to Computer | 401 to 404 |
| | 06. CPU Unit Terminal | CPU Unit Terminals | 451 to 454 |
| | 07. Sequence Control | Step Ladder Program | 301 |
| | 08. SCADA I/F | Expanded CPU Unit Terminals and Send/Receive All Blocks | 455 to 462 |
| | 10. Temporary Memory | Internal switches (registered with default with block address 349) | 209 |
| | 11. Block Diagram | Control Blocks | 001 to 040 |
| | | External Controller Block | 045 |
| Alarm/Signal Restrictions/Hold, Arithmetic, Functions, Time Functions, Signal Selection/Switching, ITEM Settings, Pulse Train Operations, Sequential Operations, Contact Operation Terminals, etc. | | 041 to 230 | |

3-1-5 Making System Common Block Initial Settings

The System Common Block (block model 000) is used to set the specifications used by all of the function blocks.

Note To use a Loop Controller, it is necessary to make the following initial function block settings.

| ITEM | Data | Data range | Default |
|------|--|--|---------|
| 004 | System common operation cycle (s) 1: 0.1; 2: 0.2; 3: 0.5; 4: 1; 5: 2 | 1 to 5 | 4 |
| 018 | Start mode 0: HOT (In the time), 1: Hot, 2: Cold, 3: CPU | 0 to 3 | 1 |
| 042 | LCU numbers (Loop Control Unit only) 0: Basic; 1: Expansion 1; 2: Expansion 2 | 0 to 2 | 0 |
| 043 | First address in the DM Area for node terminals (Loop Control Unit only) (The same address must be used for LCU number 0, 1, and 2.) | 0 to 32767 (in one-word increments) | 16020 |

- 1, 2, 3...
1. Double-click **000.System Common** under the System Common Block folder. The following dialog box will appear in the right pane.

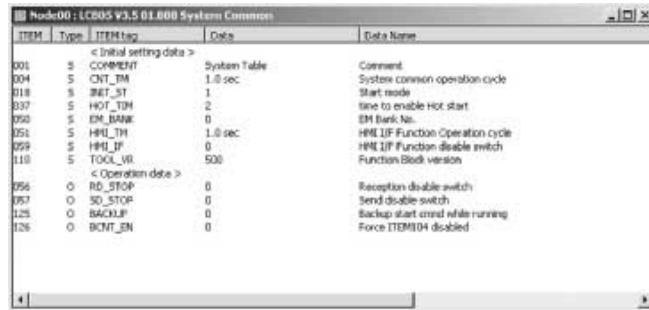

2. Input the default System Common Block settings.
The following example shows how to set the System Common Operation Cycle, for example.

Double-click the ITEM 004 line. The following dialog box will appear.



3. Input the data value and click **OK**. To set the next ITEM, click **Next**. To set the previous ITEM, click **Back**.

3-1-6 Registering Function Blocks

Use the following procedure to register a function block.

- 1, 2, 3...**
1. With a block diagram displayed, left-click the function block category displayed in the function block registration bar. The cursor will be changed into a cross.
 2. Move the cursor to the registration position on the block diagram, and left-click.

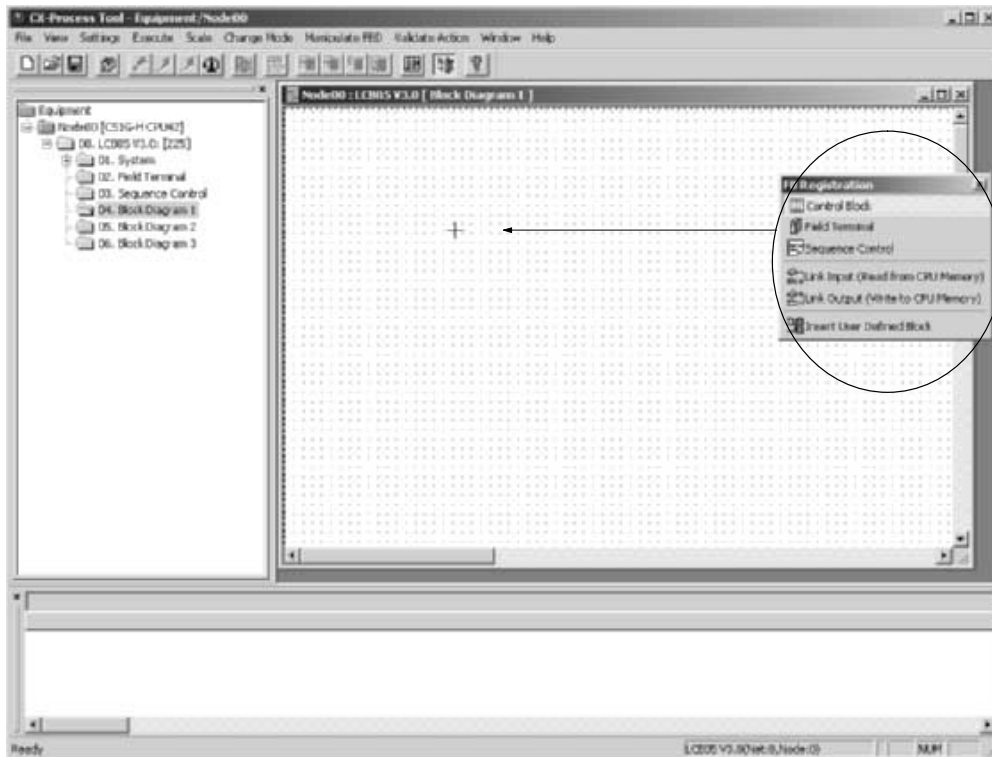

3. One of the following dialog boxes will be displayed, depending on the type of function block selected. Perform the specified actions for the dialog box that is displayed.

- 1) Control Block

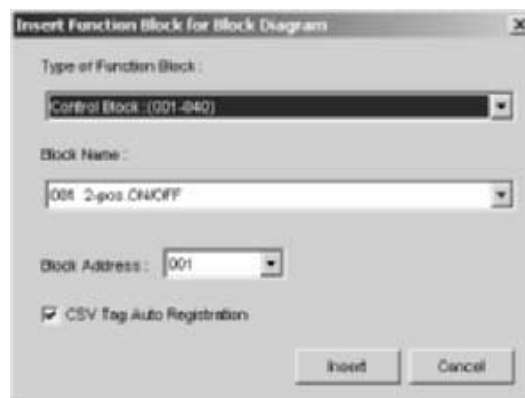

Select the function block type, the function block name, and the block address to be registered. If CSV tags are to be registered automatically, select the checkbox. For details, refer to *3-4 Using SCADA Software*.

2) Field Terminal Block

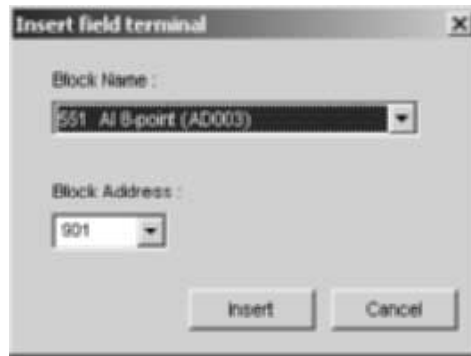

Select the Field Terminal Block name and the block address to be registered.

3) Sequence Control Block

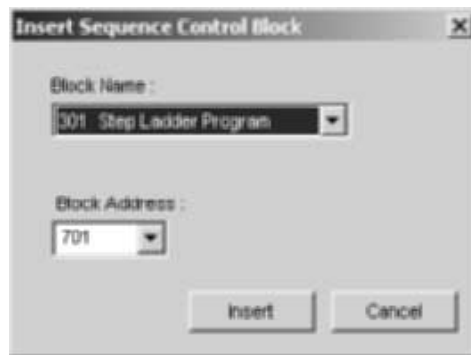

Select the Sequence Control Block name and the block address to be registered.

- 4) Link Input or Link Output
No dialog box is displayed.
- 5) User-defined Block



Select the User-defined Block.

- 4. Click the **Set** Button. The block address will be automatically incremented.
 - To allocate another function block of the same type or a different type, repeat the above registration procedure from step 3.
 - When the maximum number of registrations has been reached, click the **Cancel** Button.

Note The following restrictions apply for the number of function blocks that can be registered to each function block group.

| Version | Maximum number of function blocks registered per function block group |
|-------------------------------------|---|
| LCB□□ Ver. 3.0 or later | 64 blocks |
| LCB□□ Ver. 2.0 or earlier, or LC001 | 16 blocks |

Note The following procedures can also be used to register a function block.

- Register the function block using the Project Workspace tree. Select the block diagram folder, and then select **Settings - Insert - Insert Function Block**.
- Register the function block by right-clicking in the block diagram. Right-click in the block diagram to display the pop-up menu, and then select **Register** and select the function block that is to be registered.

Registering Other Function Blocks (Loop Controller Units Only)

With Loop Control Units, the following block groups can be registered: Send Terminal to All Nodes, Receive Terminal from All Nodes, Send Terminal to Computer, CPU Unit Terminal, and SCADA Interface. For details on these function blocks, refer to the *Function Block Reference Manual*.

Display Registered Function Blocks

- 1, 2, 3... 1. Each block address registered is displayed on the tree on the Project Workspace Screen.

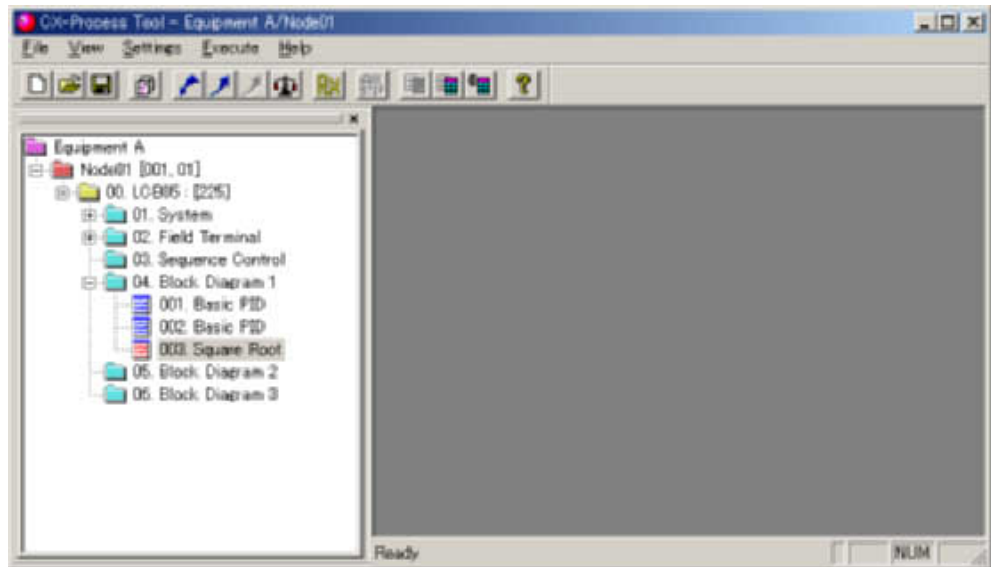

The block address is displayed with the block address and function block name as shown below.

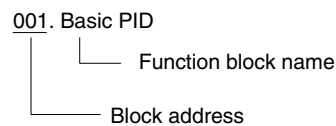

3-1-7 Editing Function Blocks

After a function block has been registered, it can be edited using the following operations.

Deleting Function Blocks

Select from the project tree the function block that is to be deleted. Then either select **Settings - Delete** or right-click and select **Delete** from the pop-up menu.

Copying Function Blocks

Select the function block in the Project Workspace. Right-click and select **Copy** (or **Cut** or **Paste**) from the pop-up menu, or select **Copy** (or **Cut** or **Paste**) from the Settings Menu.

Note Function blocks can be copied and pasted only within the same node. They cannot be pasted to different LCU/LCB elements.

Changing Block Addresses

Select the function block in the Project Workspace. Right-click and select **Block – Increment Block Address** from the pop-up menu, or select **Block – Increment Block Address** from the Settings Menu. The block address for the selected function block will be incremented.

Note When a block address is changed, the allocated HMI interface addresses for that function block will be changed. When using the HMI interface with SCADA or a ladder program, change the PLC memory allocations.

3-1-8 Editing Block Diagrams

Basic Editing Functions

Connect function blocks with the analog signals and the accumulator signals while displaying registered function blocks in graphic form.

There are the following two types of block diagram. The notation method is determined by the Loop Controller (LCB□□) being used.

| Version | Function block layout method |
|-------------------------------------|---|
| LCB□□ Ver. 3.0 or later | Block diagrams can be positioned without restriction (called the Free Location Mode). |
| LCB□□ Ver. 2.0 or earlier, or LC001 | Function blocks must be position on any of 18 fixed locations (called the Fixed Location Mode). |

Note The Free Location Mode cannot be used on versions before version 3.0. The Fixed Location Mode cannot be used on version 3.0 or later.

The following example shows the actual methods for connecting function blocks. The editing functions described here are pasting, creating connections between ITEMS, and moving blocks using the mouse.

Example

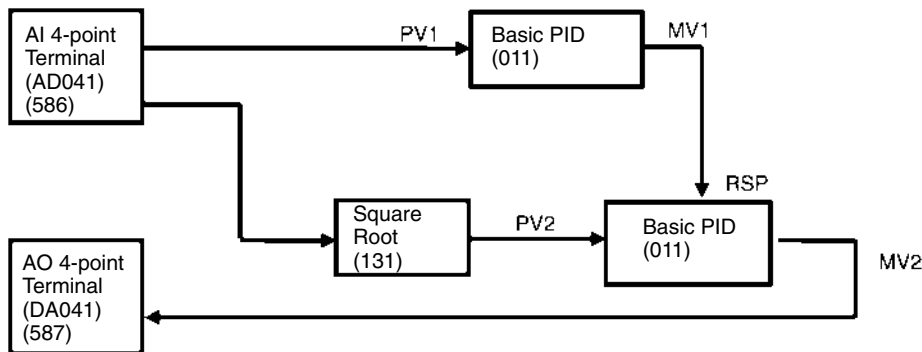

Using the Free Location Mode

- 1, 2, 3... 1. Select the folder for block diagram 1. Select **Settings – Edit – Edit/Block Diagram** or double-click the folder for block diagram 1. The following window will be displayed.

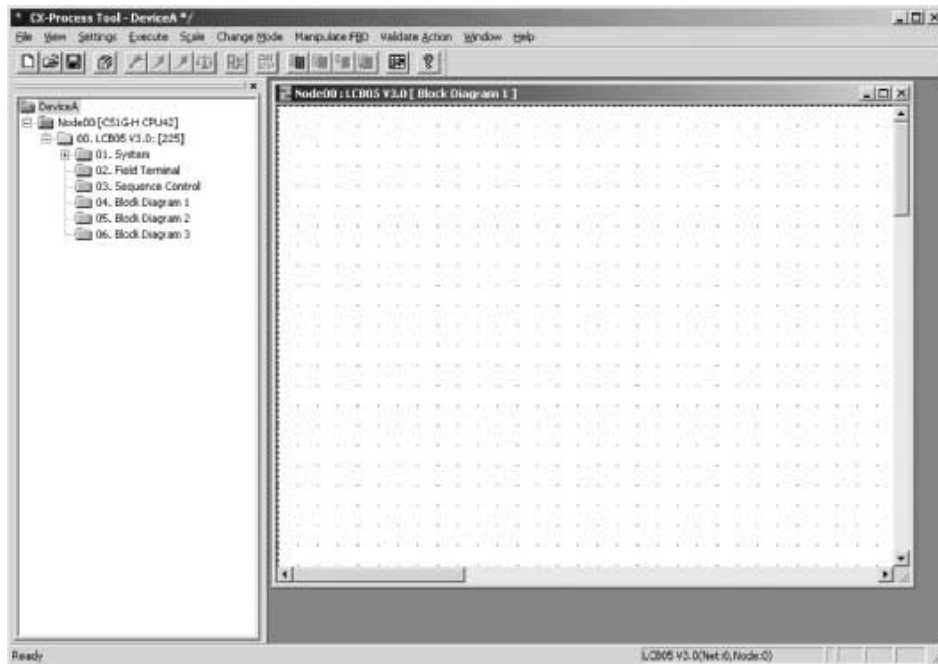

- To zoom out from the display, select **Zoom Out** from the Scale Menu or press the **Alt + Right Cursor** Keys.
 - To zoom in from the display, select **Zoom In** from the Scale Menu or press the **Alt + Left Cursor** Keys.
2. Setting the Block Diagram Width
Select **File – Print – Block Diagram**. The following Drawing Area Setting Dialog Box will be displayed.

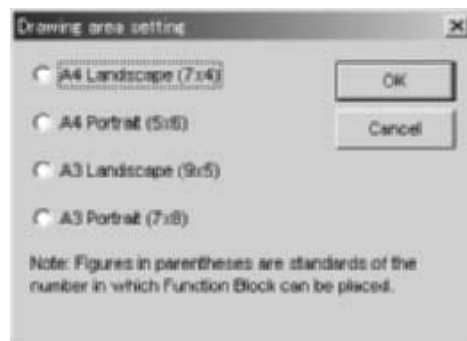

- Select the drawing area and click the **OK** Button.
- Up to 64 function blocks can be used in one block diagram. The figures in parentheses in the dialog box are rough standards taking visibility into account.
3. Changing the Grid Width
Select **Change Mode – Grid Mode** or click the block diagram and select **Display Mode – Grid Mode**.
Wide, Middle, Narrow, and Grid OFF can be selected from the submenu. Select the appropriate width. The function block and connected lines will move along the grid. The default setting is *Middle*.

4. Select (i.e., highlight) the block to be pasted in the left pane (the Project Workspace).
5. Right-click the location at which the block will be pasted in the right pane and select *Paste: Function Block* from the pop-up window. The function block diagram will be pasted as shown in the following figure.

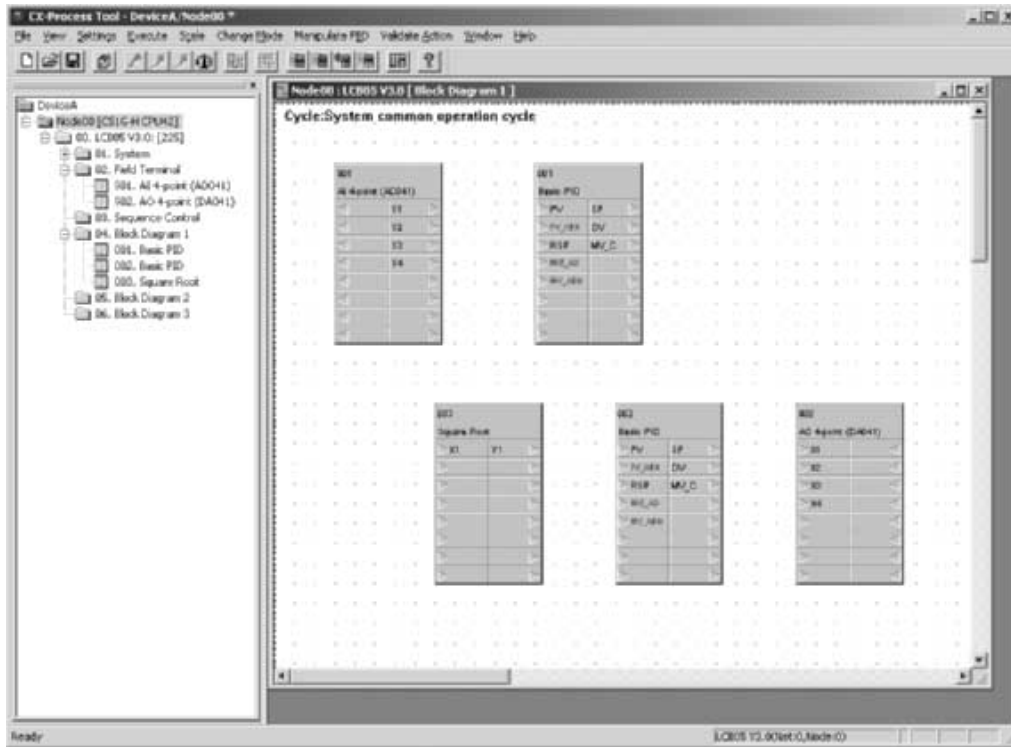

Changing Function Block Positions

Left-click the block. The hand icon (i.e., mouse cursor) will form a gripped hand. Drag the gripped hand icon to the specified position. The following display will be shown if another function cycle block already exists at the specified location.



If this display is shown, release the function block after changing the specified location.

6. The cursor will automatically form a pencil icon when it is moved to the location where the connection lines start.
7. Click the ITEM location where the connection lines will start, then point to the ITEM location where the connection lines will end and double-click. The connection lines will be displayed. To connect function blocks by going

around other blocks, connection lines can be bent at right angles. Connect the function blocks by clicking at the corner of the bend.

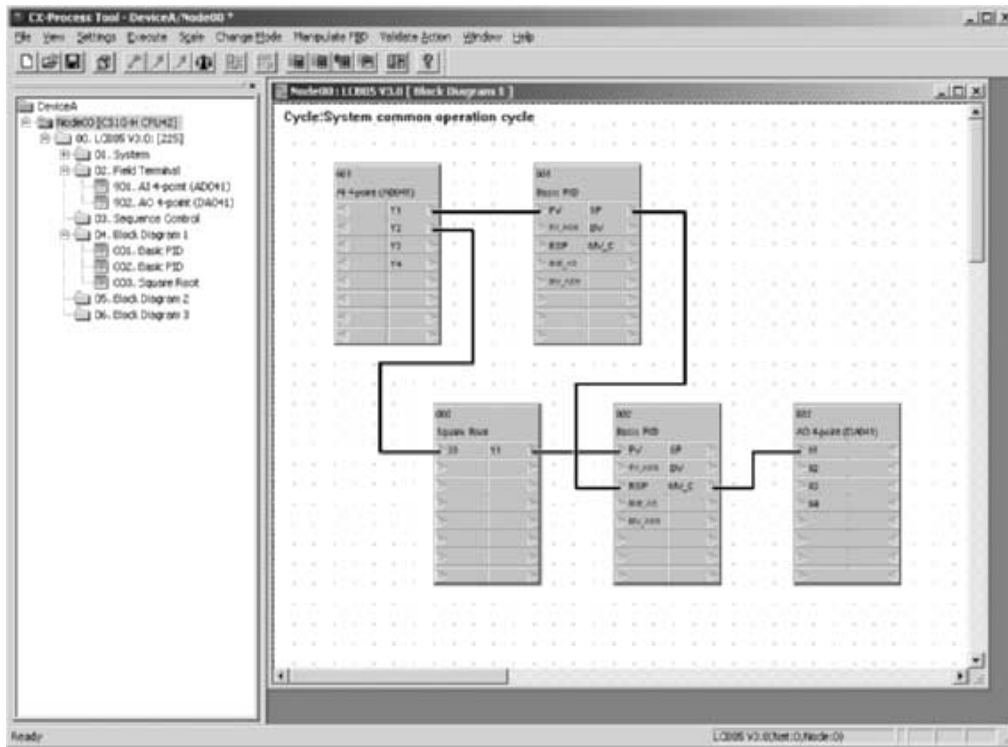

- The ITEM names will be displayed when the cursor is moved to the end-point ITEM, as shown below.



- Deleting Lines
Right click on a line to delete it. The line will be highlighted in red. Delete the line from the right-click menu.
- Confirming Connection Line Destinations on Block Diagrams
All information can be displayed for lines connected to ITEMS in block diagrams. If an ITEM is left-clicked, all lines connected to the ITEM will be highlighted in pink.

Note In the Free Location Mode, 64 function blocks can be pasted in one block diagram. Software connections can be made between block diagrams by pasting a function block with the same block address in each block diagram.

8. The data resulting from the connections will automatically be registered to the ITEMS for each block. In the above example, the block address and

ITEM number for the connection line destination will be stored in Square Root Block Item 007 as shown in the following figure.

| ITEM | Type | ITEM use | Data | Data Name |
|------|------|------------------------|-----------------------------|------------------------------|
| | | < Initial setting dat. | | |
| 001 | S | COMMENT | Rooter | Comment |
| 002 | S | MODEL | 131 | Model/Square Root |
| 004 | S | CNT_TMEX | System common operation ... | Operation cycle(Dcommon) |
| 005 | S | SCAN_NO | 2000 | Operation order |
| 007 | S | XI_AD | 901.022 | XI source designation |
| | | < Operation data > | | |
| 009 | O | K1 | 1.000 | Gain |
| 010 | O | A1 | 0.00 | Input low-end cutout setting |

For example, for the Basic PID Block, the PV destination block address and ITEM will be stored as shown in the following figure.

| ITEM | Type | ITEM use | Data | Data Name |
|------|------|------------------------|-----------------------------|-----------------------------|
| | | < Initial setting dat. | | |
| 001 | S | COMMENT | Basic PID | Comment |
| 002 | S | MODEL | 011 | Model/Basic PID |
| 004 | S | CNT_TMEX | System common operation ... | Operation cycle(Dcommon) |
| 005 | S | SCAN_NO | 2000 | Operation order |
| 006 | S | PV_AD | 901.021 | PV source designation |
| 012 | S | HS_SP | 1.00 | Hysteresis setting |
| 018 | S | PVE_AD | 000.000 | PV error source designation |
| 020 | S | ALM_LIM | 0 | Alarm limit |
| 021 | S | RSP_AD | 000.000 | RSP source |

Using the Fixed Location Mode

- 1, 2, 3...
- To edit the block diagram (i.e., to make software connections for analog and accumulator signals), select the **Block Diagram 1** folder, and then select **Edit – Block Diagram** from the Settings menu.

The following blocks will appear in the right pane.

- Three rows of six function blocks can be allocated to a single block diagram.
- To zoom out from the display, click the Zoom Out from the menu or press the **Alt + Right Cursor** Keys.
- To zoom in to the display, click the Zoom In from the menu or press the **Alt + Left Cursor** Keys.

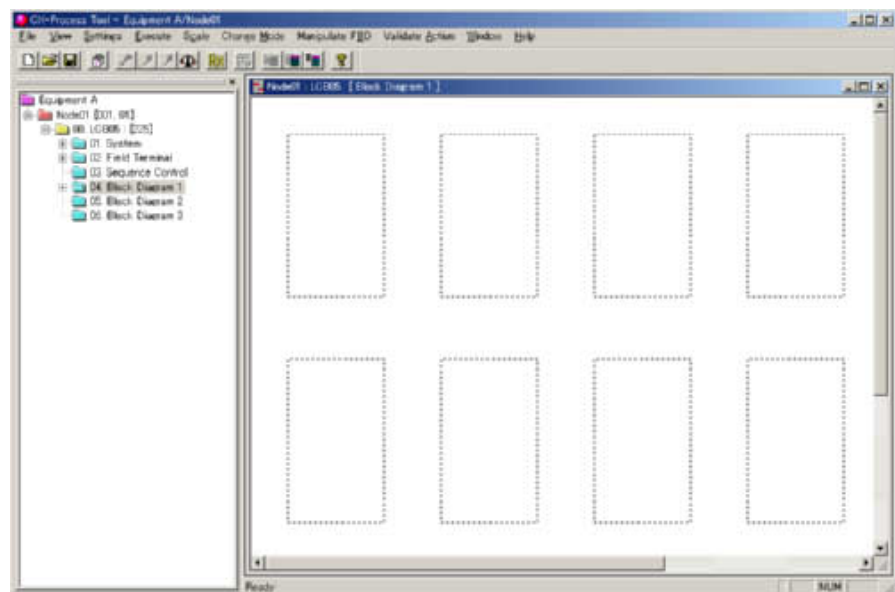

- In the Project Workspace Screen, select the block to be pasted. The block will be highlighted.

3. Click the right mouse button at the pasting position in the right pane. Select **Paste: Function Block** from the pop-up menu.
The function blocks will be pasted as shown below.

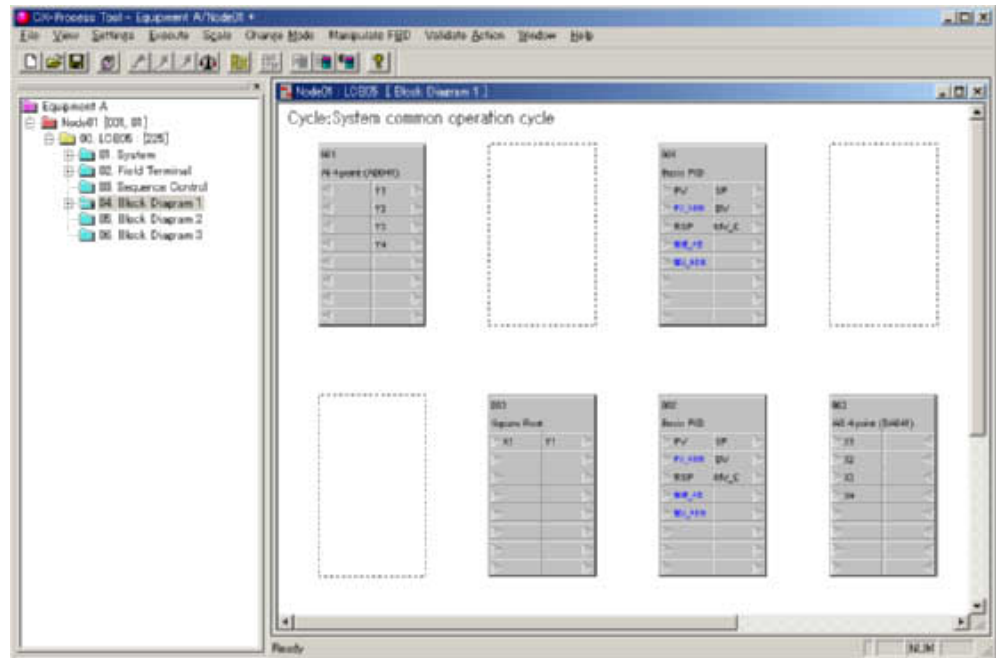

- To change the position of a function block, select the block (the cursor will change to a hand) and drag it to the desired position.
4. The cursor will automatically be changed to a pencil icon when the cursor is moved to the connection's start point.
5. Click the start point of the connection and double-click the end point. The software connection will appear. To bypass the route, click the apex of the corner so that the direction can be changed by 90.

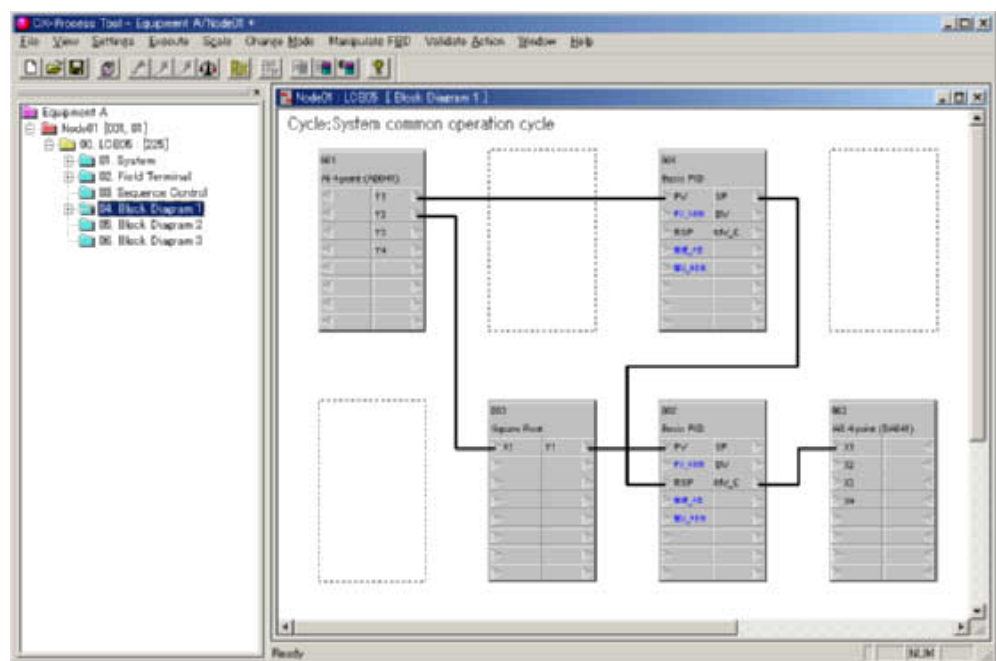

Note a) The ITEM name will be displayed if you point at the ITEM at the end point. Confirm ITEM names when making connections.

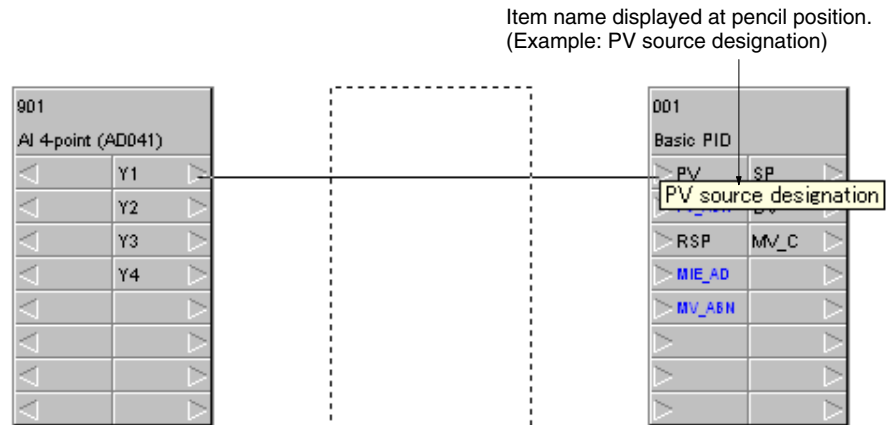

- b) The **Grid Mode** can also be selected to position lines on a grid. Grid Mode can be turned ON and OFF during either Block Connection Mode or Move Block Mode.
- c) To delete a line, select the line to be deleted, click the right mouse button (the line will be displayed in red), and select **Delete Line** from the pop-up menu.
- d) A red frame is not displayed on an ITEM specified as the starting point of a connection with CX-Process Tool Software version 2.50 and higher.
- e) Up to three rows of six function blocks can be allocated to a single block diagram. To connect more function blocks, select the LCU/LCB folder, select **Insert**, and add the new function blocks. To connect two function blocks in different block diagrams, place a function block with the same block address in each diagram.

Note A total of only 18 function blocks can be pasted into a block diagram in Fixed Location Mode (3 × 6 = 18 blocks). To connect more function blocks, select the LCU/LCB folder (Loop Controller) and select **Setting – Insert – Insert Block Diagram** to add a new block diagram. To make software connections between block diagrams, paste a function block with the same block address in each block diagram.

- 6. Data on the result of software connection is registered with the ITEM of each function block automatically. In the above example, Square Root Block ITEM 007 will store the following block address of the destination and ITEM number.

| ITEM | Type | ITEM use | Data | Data Name |
|------|------|--------------------------|-----------------------------|------------------------------|
| | | < Initial setting data > | | |
| 001 | S | COMMENT | Footer | Comment |
| 002 | S | MODEL | 131 | Model/Square Root |
| 004 | S | ONT_TMEX | System common operation ... | Operation cycle/(common) |
| 005 | S | SCALE_NO | 2000 | Operation order |
| 007 | S | XI_AD | 901 022 | X1 source designation |
| | | < Operation data > | | |
| 009 | O | K1 | 1.000 | Gain |
| 010 | O | A1 | 0.00 | Input low-end cutoff setting |

For example, for the Basic PID Block, the PV destination block address and ITEM will be stored.

| ITEM | Type | ITEM tag | Data | Data Name |
|------|------|--------------------------|-----------------------------|-----------------------------|
| 001 | S | < Initial setting dat... | Basic PID | Comment |
| 002 | S | COMMENT | 011 | Model:Basic PID |
| 004 | S | MODEL | System common operation ... | Operation cycle:(common) |
| 005 | S | CNT.TMEX | 2000 | Operation order |
| 006 | S | SCAN_NO | 901.021 | PV source designation |
| 012 | S | RSP_AD | 180 | Hysteresis setting |
| 018 | S | PVE_AD | 000.000 | PV error source designation |
| 020 | S | ALM_LIM | 0 | Alarm limit |
| 021 | S | RSP_AD | 000.000 | RSP source |

Other Editing Functions

Selecting Lines

- **Selecting One Line**
The line will be highlighted in red when it is right-clicked. Use this procedure mainly for deleting lines.
- **Selecting All Lines Connected to an Item**
All information can be displayed for lines connected to ITEMS in block diagrams. If an ITEM is left-clicked, all lines connected to the ITEM will be highlighted in pink. Right-click and select **Release Selection** from the pop-up menu to unselect lines.
- **Selecting All Lines Connected to a Function Block**
All information can be displayed for lines connected to function blocks in block diagrams. If a function block is left-clicked, all lines connected to the function block will be highlighted in pink. Right-click and select **Release Selection** from the pop-up menu to unselect lines.

Deleting Lines

Select a line and select **Delete Line** or **Delete Selected Lines**.

- **Selecting One Line**
Right-click and select **Delete Line** from the pop-up menu.
- **Selecting Multiple Lines**
Right-click and select **Delete Selected Lines** from the pop-up menu.

Copying Block Diagrams

Block diagrams can be copied to register new block diagrams. Using this function, each function block registered in the block diagram is copied to a new function block group. Use the following procedure.

- 1) Right-click the function block group (i.e., copy source block diagram) in the Workspace and select **FBD – Copy** from the pop-up menu.
- 2) Select the LCB/LCU element (i.e., LCU or LCB) and then select **FBD – Paste** from the Settings Menu, or right-click and select **FBD – Paste** from the pop-up menu.
- 3) The *Insert Function Block for Diagram* Dialog Box will be displayed. Select the number and name for the function block group.
- 4) A dialog box for automatically setting CSV tags will be displayed. Select **Yes** to automatically perform settings for function blocks created by copying a block diagram.

The following restrictions apply when copying block diagrams.

- Parameters will also be copied.
- Only the blocks that are pasted to the block diagram will be copied. Function blocks that are registered to function block group trees and not pasted to block diagrams will not be copied.
- Block diagrams cannot be pasted to other nodes. The copy buffer will be cleared if the active node is switched.
- Block diagrams cannot be pasted to other LCU/LCB elements (e.g., pasting an LCB block diagram to an LCU block diagram).

Registering User Link Table Blocks (Settings for Data Exchange with CPU Unit: Not Possible for Loop Control Unit)

With a Loop Control Board, Process-control CPU Unit, or Loop-control CPU Unit, a user link table can be registered by pasting it on the block diagram. This enables easily setting software connections for data exchange between the Board and I/O memory in the CPU Unit.

Refer to *3-5 User Link Tables* for details on user link tables.

- 1, 2, 3...**
1. Paste the user link table on the block diagram as described below. (Input user link tables and output user link tables are pasted separately.)
 - Input User Link Tables (Reading data from the CPU Unit to the Loop Controller)

Right-click on the block diagram and select **Register/User Link Table/Link Input (Read from CPU Memory)** from the pop-up menu.
 - Output User Link Tables (Writing data from the Loop Controller to the CPU Unit)

Right-click on the block diagram and select **Register/User Link Table/Link Output (Write to CPU Memory)** from the pop-up menu.

The following type of function Table block will be pasted into the block diagram.
Example: Input User Link Table



2. Right-click on the ITEM to be set and select **Register/User Link Table/Register Block Cell** from the pop-up menu. The ITEM will be displayed with a red border and the following dialog box will be displayed.



3. Select the name of a user link table tag that has been registered or input a new tag to register it in the user link table.

As shown below, the I/O memory address (here, DM00000) in the CPU Unit that corresponds to the selected tag will be displayed.



To change the display to the tag name, right-click and select **Display Mode/CSV Tag Mode** from the pop-up menu. A checkmark will be added to the menu and the tag name will be displayed instead of the I/O memory address.

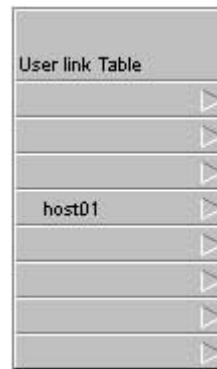

4. Create software connections, just as for other function blocks. In the following example, tag name host01 in the user link table has been set as the RSP for a Basic PID function block.

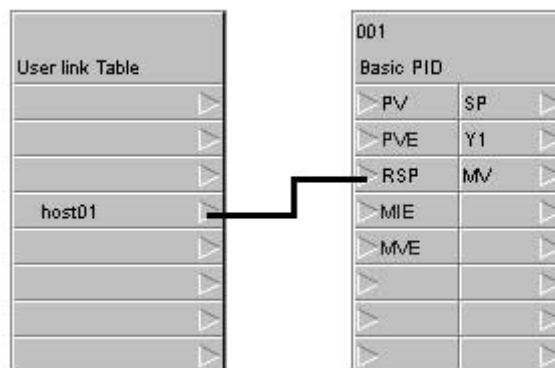

Inserting Comments (Annotations)

With CX-Process Tool versions 2.50 and higher, it is possible to insert annotations (user-defined text) into block diagrams in Edit Block Diagram Mode. Up to 16 annotations can be inserted in one block diagram and up to 3,000 annotations can be inserted in one function block file. Each annotation can be up to 200 characters long.

This function allows user-set labels (such as “Tank 1 Temp. Control” or “Tank Temp.”) to be inserted and displayed in function blocks or I/O wiring. The dia-

grams with annotations can also be printed out to create complete schematics showing the system configuration. (The annotation data cannot be downloaded to a Loop Controller. For details on downloading annotation data, refer to 4-9 *Transferring Tag and Comment Data* on page 309.)

Use the following procedure to insert annotations.

- 1, 2, 3...** 1. Click the right mouse button to display the pop-up menu and select **Annotations/Insert**. The new annotation will contain the default text “Comment Data” as shown in the following diagram.

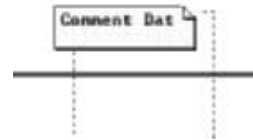

2. To edit the text in the annotation, double-click the annotation or select the annotation, right click the mouse button to display the pop-up menu and select **Annotations/Selected Annotation/Edit**. The following diagram shows the appearance of the annotation when it can be edited.

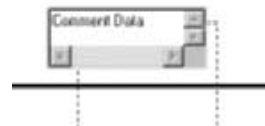

3. Input the text. In this example, “Tank Temp. (PV1)” has been input. (Press the **Enter** Key to create a new line.)

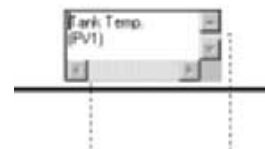

4. To stop editing the annotation, click on something other than the annotation. The annotation will contain the new text.

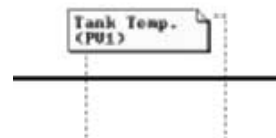

- Note** a) To change the size of the font in the annotation, select the annotation, click the right mouse button to display the pop-up menu and select **Annotations/Selected Annotation/Font Size**. (The default font size is 12 points.)
- b) The annotation can be enlarged if necessary. (The default size is the minimum size, so the annotation cannot be made smaller than the default.) Select the annotation, select the **■** symbol on the right side of the annotation (arrows will be displayed on both sides of the symbol), and enlarge the annotation.

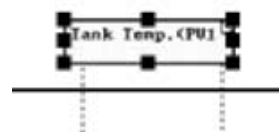

5. Grab the annotation and move it to the desired position.

- Note**
- a) When the annotation is displayed over a function block or connecting line and covers it up, click the right mouse button to display the pop-up menu and select **Annotations/Selected Annotation/Send Behind Blocks and Lines**.
 - b) If two annotations overlap, either one can be moved to the front or back by clicking the right mouse button to display the pop-up menu and selecting **Annotations/Selected Annotation/Bring to Front** or **Annotations/Selected Annotation/Send to Back**.

Order of Execution in Block Diagrams

Internal Loop Controller operations are executed according to the operation cycle set for each function block. Steps 1 to 4 below are executed in each of the eight types of operation cycles. For details on the operation cycles can be set for function blocks, refer to the *Loop Control Boards Function Block Reference Manual*.

- 1. User Link Tables: Read attributes, written as “Rd” (LCB) in the CX-Process Tool
- 2. System Common Block
- 3. Control, External Controller, and Sequence Blocks

The order of execution is as follows:

- 1) In order of operation sequence (ITEM 005)
- 2) In order of function block address
- 4. User Link Tables: Write attributes, written as “Wr” in the CX-Process Tool (LCB→)

With the CX-Process Tool, the function block operation sequence (ITEM 005) can be registered as described below.

- **Registering from ITEM Lists**
Directly edit ITEM 005 in each function block, and set the operation sequence (1 to 2,000). The default setting is 2,000.
- **Batch Registration from Block Diagrams**
Select **Settings/Setting Block Operating Order** from the menus. The following operation sequence will be set automatically.

Free Location Mode

The priority for the order of operation is based on the following rules.

- 1) In ascending order of the X coordinates of the function block position
- 2) In ascending order of the Y coordinate of the function block position

Example: The following figure shows a block diagram with nine function blocks pasted. When the operation cycle batch setting is executed, the operation sequence will be automatically set to 1, 2, 3, . . . 9. (The dotted portion is the same as the X coordinate, so function blocks are pasted in ascending order of the Y coordinate.)

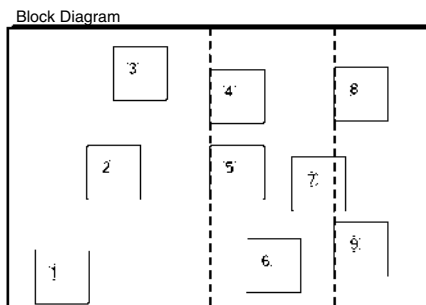

Fixed Location Mode

The order of priority is automatically set to 1, 2, 3, . . . 18 starting from the upper left when the operation cycle batch setting is executed.

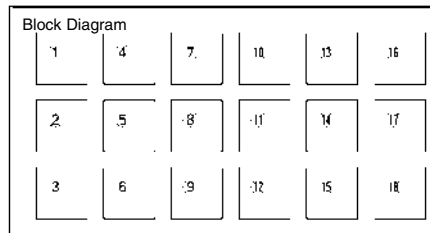

Note If the same function block is pasted to multiple connection diagrams, the operation sequence on the block diagram for the lower-numbered function block will be enabled.

Displaying Connection Maps

To check the I/O relationships for a function block, select the function block on the Navigator and select **Operation/Connection Map**. As shown below, a connection map showing the input source ITEMS and output destination ITEMS will be displayed around the function block.

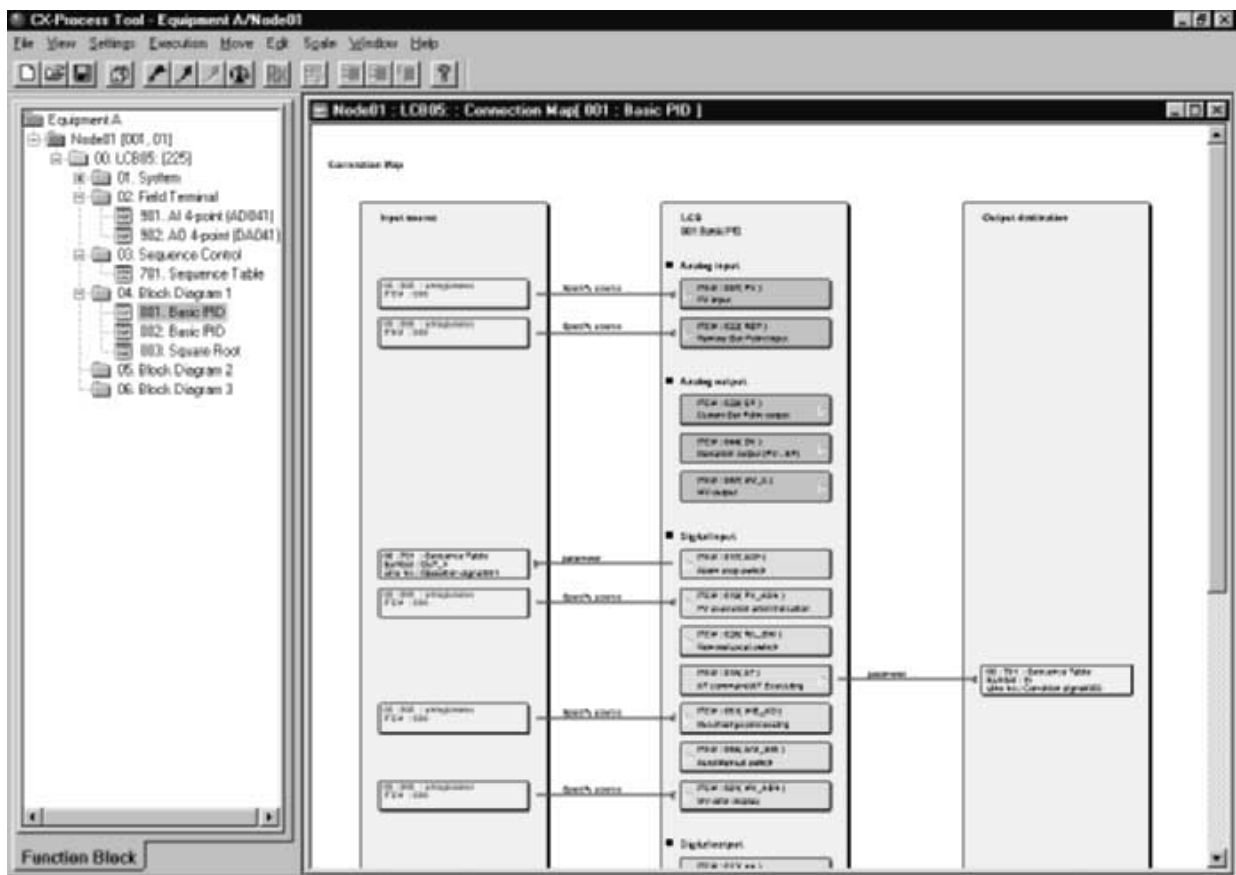

This connection map will allow checking the I/O relationship for individual ITEMS. The connection map can also be printed by right-clicking on the map and selecting **Print**.

Note Connection maps can also be displayed for function blocks using addresses specified in the I/O memory of the CPU Unit. Right-click on the map and select **Jump/Memory Area/Optional** and specify the I/O memory address. The speci-

fied address can be incremented by selecting **Jump/Memory Area/Increment** and decremented by selecting **Jump/Memory Area/Decrement**.

3-1-9 Editing ITEMS in Function Blocks

Use the following procedure to set the ITEMS in each function block.

- 1, 2, 3... 1. Double-click the function block Name (the block address of which is shown on the left-hand side) on the Project Workspace Screen. A list of the ITEMS will appear in the right pane.

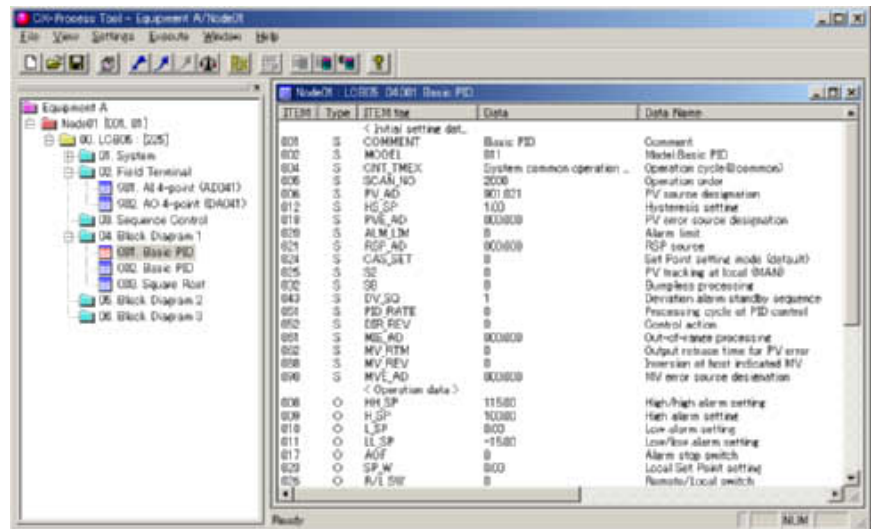

The initial setting data (S) and operation data (O) appears in the *Type* column. Each ITEM for which the letter S appears in the *Type* column (i.e., initial setting data) must be set with the CX-Process Tool. Any ITEM for which the letter O appears in the *Type* column (i.e., operation data) can be set with the CX-Process Monitor.

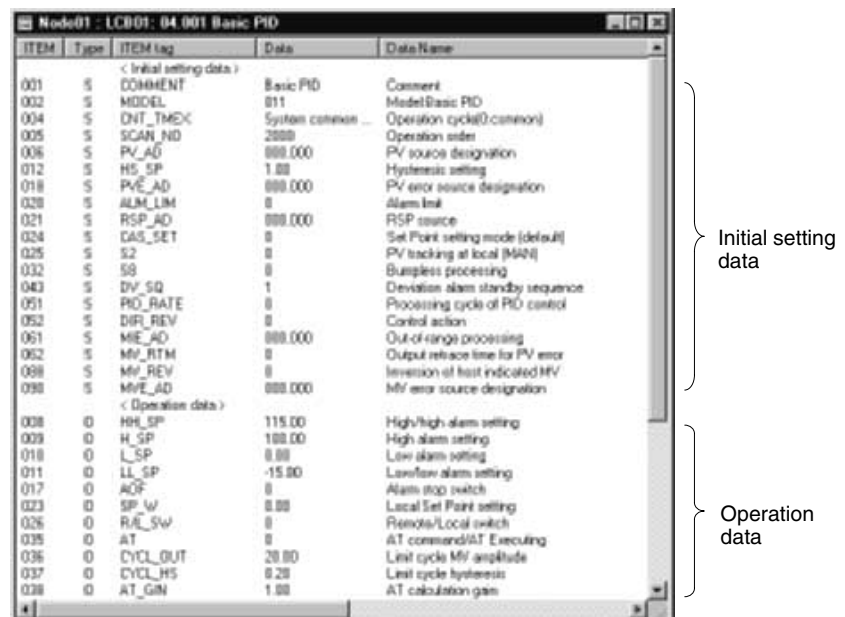

Note ITEMS are displayed by default in the order of S and then O. It is possible to display ITEMS in ascending order by clicking on **ITEM**. The following display will appear.

| ITEM | Type | ITEM tag | Data | Data Name |
|------|------|----------|---------------|----------------------------------|
| 001 | S | COMMENT | Basic PID | Comment |
| 002 | S | MODEL | 011 | Model/Basic PID |
| 004 | S | ONT_TMDC | System common | Operation cycle(D:common) |
| 005 | S | SCAN_NO | 2000 | Operation order |
| 006 | S | PV_AD | 000.000 | PV source designation |
| 008 | O | HH_SP | 115.00 | High/high alarm setting |
| 009 | O | H_SP | 100.00 | High alarm setting |
| 010 | O | L_SP | 0.00 | Low alarm setting |
| 011 | O | LL_SP | -15.00 | Low/low alarm setting |
| 012 | S | HS_SP | 1.00 | Hysteresis setting |
| 017 | O | ACF | 0 | Alarm stop switch |
| 018 | S | PVE_AD | 000.000 | PV error source designation |
| 020 | S | ALM_LIM | 0 | Alarm limit |
| 021 | S | RSP_AD | 000.000 | RSP source |
| 023 | O | SP_W | 0.00 | Local Set Point setting |
| 024 | S | DAS_SET | 0 | Set Point setting mode (default) |
| 025 | S | S2 | 0 | PV tracking at local (MAN) |
| 026 | O | RL_SW | 0 | Remote/Local switch |
| 032 | S | S8 | 0 | Bumpless processing |
| 035 | O | AT | 0 | AT command/AT Executing |
| 036 | O | CYCL_OUT | 20.00 | List cycle M/A amplitude |
| 037 | O | CYCL_HS | 0.20 | List cycle hysteresis |
| 038 | O | AT_GIN | 1.00 | AT calculation gain |
| 039 | O | AT_DEV | 10.00 | Judgment DEV for provisional AT |
| 040 | O | AT_TYP | 0 | AT type |
| 041 | O | DVA_SP | 115.00 | Deviation alarm setting |
| 043 | S | DV_SQ | 1 | Deviation alarm standby sequence |
| 051 | S | PRO_RATE | 0 | Processing cycle of PID control |
| 052 | S | DIR_REV | 0 | Control action |
| 054 | O | P | 100.0 | Proportional band |
| 055 | O | I | 0 | Integral time(D:No action) |
| 056 | O | D | 0 | Differential time(D:No action) |

2. Double-clicking on the desired setting item. The corresponding dialog box will appear.

For example, by double-clicking on the operation cycle of ITEM004, the following dialog box will appear.

DLX001 ITEM=004

Data Name: Operation cycle(D:common)
 Data Range: Integer Data: 0-8
 Data Description: 1:0.1, 2:0.2, 3:0.5, 4:1, 5:2, 6:0.01, 7:0.02, 8:0.05Sec

General data
 Data:

Correction data
 Item/ITEM Number
 Data:

Tag Name/Field/Items/Sequence/Control
 Function Block Group:
 Field/ITEM:
 ITEM:

User LSP Table
 Entry:

Buttons: Back, Next, OK, Cancel, Transfer to CL

3. Input the value and click **OK** or press the **Enter** Key. To set the next ITEM, click **Next**. To set the previous ITEM, click **Back**.

Note When the computer is online, you can click **Download** to download just the value that was set. If this method is used, the new value will be downloaded but the ITEM list will not be refreshed and the ITEM list will show the computer's offline value for that ITEM rather than the actual value in the Loop Controller.

4. Set other ITEMS in the same way.

Initial Settings (S) and Operation Data (O)

The following table provides the details of initial settings (S) and operation data (O).

| Unit | Description |
|---|--|
| Initial settings (S) | Initial settings in each function block in the data in an LCU/LCB element that exists in a function block file (.ist) and step ladder programs. Note Data on the registered function blocks (i.e., data on the allocation to the block address) and data on the software connection of analog and accumulator signals. |
| Operation data (O) | Data for operating each function block in the data in an LCU/LCB element in a function block file (.ist). |
| Initial settings and operation data (S + O) | All the data in an LCU/LCB element in a function block file (.ist). |

The CX-Process Tool is normally used to set initial data S and the CX-Process Monitor is used to set operation data O.

| Data classification | Type | ITEM | Example: PID Block | CX-Process Tool | CX-Process Monitor |
|---------------------|------|---|---|----------------------|--------------------|
| Initial settings | S | Initial setting parameter for each function block | Forward/Reverse direction, SP setting method, compensation method, etc. | Set | Cannot be set |
| Operation data | O | Operation parameters for each function block | Example: PID Block SP, alarm settings, PID constants, etc. | Set in special cases | Set |

Note Use the above classification when transferring or comparing function block data to the Loop Controller. Refer to 4-3 *Downloading, Uploading and Comparing Data*. Initial settings O and operation data S classifications are displayed on ITEM Setting Screens of the CX-Protocol Tool. For details on the ITEMS set each function block, refer to the *Function Block Reference Manual*.

(S): Initial setting data (set with the CX-Process Tool)
(O) Operation data (set with the CX-Process Tool or CX-Process Monitor)

| Type of ITEM | ITEM | ... | Write/Read method R: Read; W: Write; R/W: Read/Write, ---: Disabled Note: r, t/w: CX-Process Tool operation monitor/Operation monitor read and write (S): Initial setting data, (O): Operation data | | | | Data length (byte) |
|--|------|-----|---|--------------------|--------------------|---------------------|--------------------|
| | | | CX-Process Tool | CX-Process Monitor | ITEM Setting block | Step Ladder Program | |
| Contact input | 000 | | — | — | — | R/W | 1 |
| Parameter | 001 | | R/W (S) | — | — | — | 24 |
| | 002 | | R/W (S) | — | — | — | 2 |
| Special | 003 | | r | — | — | — | 2 |
| Parameter | 004 | | R/W (S) | — | — | — | 2 |
| PV | | | | | | | |
| Analog input block diagram information | 005 | | R/W (S) | — | — | — | 4 |

Note In Edit Block Diagram Mode, an ITEM displayed in blue can be set as well by selecting the ITEM, clicking the right mouse button, and selecting **Edit – Edit Connection** from the pop-up menu. Either input **BBBIII** or select from the **Function Block Group, Block/ITEM**, and **ITEM** pull-down lists.

Example: Setting PV Error (PVE) Source in Basic PID Block

- 1, 2, 3... 1. Select the blue ITEM.

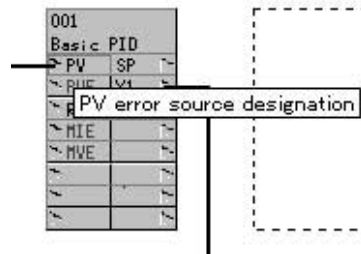

2. Click the right mouse button and select **Edit – Edit Connection** from the pop-up menu.
3. The following dialog box will appear. Select the **Block/ITEM No.** and input the value, or select **Tag Name/Field Terminal/Sequence Control** and select from the **Function Block Group**, **Block/ITEM**, and **ITEM** pull-down lists.



Note The pull-down list can be used only for LCB□□. If the destination is an ITEM, a field terminal cannot be selected from the *Block/ITEM* pull-down list. To use a field terminal, register a user link table and then select from the list.

3-1-10 Saving the Project Workspace

Save the created Project Workspace as a project file (.mul) in a folder of the project name.

When saving the project file, all the following files will be saved in the same project folder. These files cover all the function block data in the Loop Controllers under one CPU Unit, except the monitor tag data.

| File type | File name extension | Remarks |
|--|-------------------------|--|
| Function block files | .ist | |
| Block diagram information files | .mtbd | |
| Mnemonics/Ladder diagram information files | .mtld | |
| Comment file | .cmt | |
| CSV tag setting file | <i>project_name.csv</i> | |
| CX-Server configuration file | .cdm | When the CX-Server is set as the communications driver |
| Job information files | .sjb | |
| Loop Controller configuration file | .lcb | |
| Data file of User Link Table (CSV format) | LnkTable.csv | |
| Data file of Sequence Table | .stbl | |

Note The monitor tag data is saved as a monitor tag file.

Saving Data in the Current Project Folder

Select **Save** from the File Menu. The created Project Workspace data will be saved in the project folder specified with **New** in the File Menu.

Saving Data in a Different Project Folder

- 1, 2, 3...**
1. Select **Save As** from the File Menu.
 2. Specify the folder where the created Project Workspace data will be saved. Click the **OK** Button.
 3. The Project Workspace data will be saved in the specified, different project folder.

Note The Project Workspace data will be saved by default in the CX-Process Tool data folder.

Note If the computer crashes or there is a power failure, the function block files (.ist) may not be saved. It is recommended to save the Project Workspace data regularly.

3-1-11 Opening a Project Workspace

Use the following procedure to open an existing Project Workspace.

- 1, 2, 3...**
1. Select **Open** from the File Menu.
The following dialog box will appear.

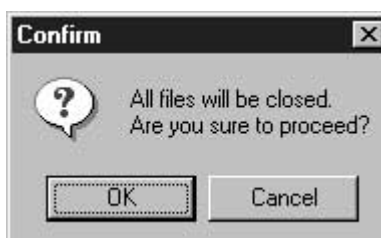

2. Click the **OK** Button. The following dialog box will appear.



3. Select the multi-node file (.mul). In the following example, “equipment A.mul” is selected.



4. Click the **Open** Button.

All the related files in the project folder will be loaded to the Project Workspace.

3-1-12 Editing Projects

Changing the LC Type

To convert the number/model and unit version to a different number/model and unit version, select **Execution - Change LC Type**. For combinations of possible changes, refer to *Appendix A Table of LC Type Changes*.

Note If LCB Unit version 3.00 or later is selected, it will not be possible to convert the data for use with LCB Unit version 2.00 or earlier as described later. Confirm the LCB version before creating an LCB.

Note The communications settings return to the default values after changing the model.

Creating Comments for Projects and Function Block Files

- You can create a user comment for the Project Workspace (project folder). Right-click the Project Workspace folder, then select **System Job Informa-**

tion from the pop-up menu. The following Register System Job Information Dialog Box will appear. Input the comment and click the **OK** Button.

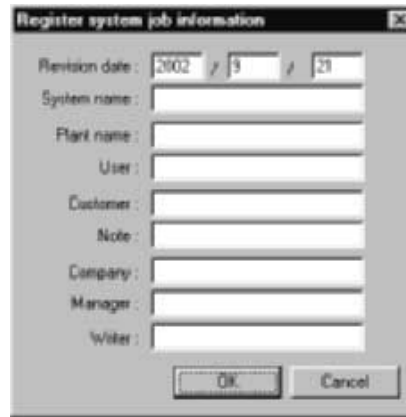

- A user comment can be input for a function block folder. Double-click the function block folder. The following Register Job Information Dialog Box will appear. Input the comment and click the **OK** Button.



Registering Multiple Nodes

The CX-Process Tool makes it possible to register a maximum of 32 nodes to a single project. Project data can be edited for only one node. The node that can be edited is called the “active node.” All editing and online operations are possible at the active node. Inactive nodes are only displayed in the tree, and they cannot be edited or controlled online.

Displaying Active Nodes

The active node is displayed as a red folder in the project tree. Inactive nodes are displayed as white folders.

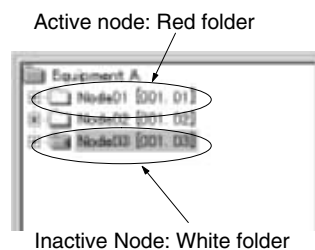

Switching to Active Node

To switch an inactive node to active, select **Settings - Set Active Node**, or select the applicable node from the project tree and then right-click and select **Set Active Node** from the pop-up menu.

Note A maximum of 32 nodes can be handled by the CX-Process Tool. If the Communications Unit is set for more than 32, it will not be possible to go online from the CX-Process Tool. Therefore, set 32 or less for the Communications Unit node numbers.

Changing Communications Drivers

The following procedures can be used to change the communications driver for a created project.

Enabling the Driver Selection Window

- 1, 2, 3... 1. Start the CX-Process Monitor.

2. Select **File - Show Driver Select Dialog - Show**.

Changing from CX-Server to FinsGateway

- 1, 2, 3...
 1. Open the project for which the communications driver is to be changed, and select a node from the project tree.
 2. Select **Settings - Change PLC** from the menu, or right-click and select **Change PLC** from the pop-up menu.
 3. The Change PLC Dialog Box will be displayed. Press the **Setting** Button for the network type.
 4. The Network Setting Window will be displayed. If the node number is 0, input a value other than 0 and then press the **OK** Button.
Note The number 0 cannot be used with FinsGateway, so input a value of 1 or higher.
 5. Save the project.
 6. Restart the CX-Process Tool and select FinsGateway as the communications driver.
 7. Open the saved project.

Changing from FinsGateway to CX-Server

- 1, 2, 3...
 1. Select CX-Server as the communications driver and start the CX-Process Tool.
 2. Open the project for which the communications driver is to be changed.
 3. A message will be displayed saying that the CX-Server project file does not exist or is corrupted, and asking if a new **.cdm file should be created. Press the **OK** Button.
 4. Save the project. This completes the operation.

3-2 Using the CX-Process Monitor

3-2-1 Setting and Compiling Monitor Tags for CX-Process Monitor

To transfer tag data to the CX-Process Monitor, take the following three steps.

- 1, 2, 3... 1. Register the function block for data exchange.

Note The following function blocks can be used to exchange data:
 Blocks Send Terminal to Computer (block models 401 to 404), AO/DO terminal to All Nodes (block models 407 or 408), and AO/DO Terminal Settings from Computer (block models 409 or 410).

2. Set the tag names.
 3. Compile the monitor tags.

Registering Function Blocks for Data Exchange with CX-Process Monitor

To monitor function blocks, contact signals, or analog signals (including parameters) from the CX-Process Monitor, register a Block Send Terminal to Computer (block model 401, 402, 403 or 404) or AO/DO Terminal to All Nodes (block model 407 or 408) Function Block, and designate the desired data in the function block as the source.

To set contact signals or analog signals (including the parameter) from the CX-Process Monitor, register a AO/DO Terminal Settings from Computer (block model 409 or 410) Function Block.

Example

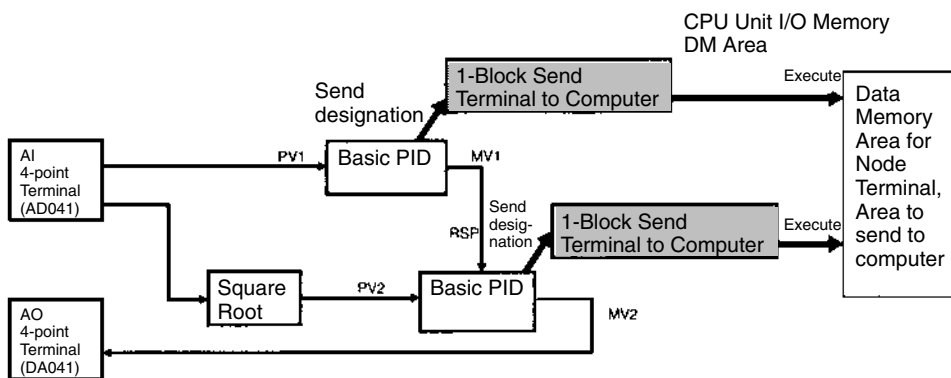

Example: A 1-Block Send Terminal to Computer is registered and block address 001 is designated as a source.

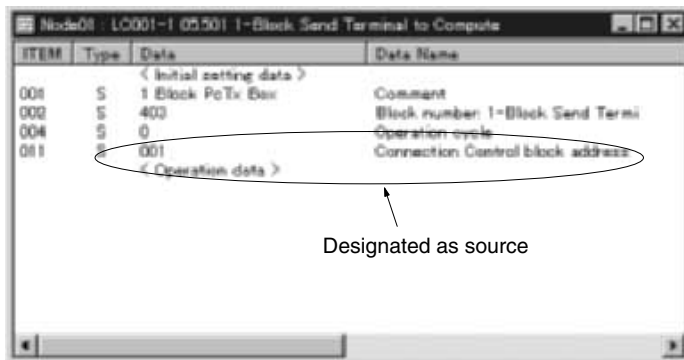

Setting Monitor Tags

Set a monitor tag for the function blocks to exchange data with the CX-Process Monitor.

1-Block Send Terminal to Computer or 4-Block Send Terminal to Computer (Block Models 403/404)

Select the 1-Block Send Terminal to Computer or 4-Block Send Terminal to Computer, and then select **Tag Setting/Monitor Tag** from the Settings Menu. The following Monitor Tags Dialog Box will appear. Input the tag name, tag comment, scale (range high limit and range low limit), decimal position, and unit data items, and then click the **OK** Button.

Note The scale (range high limit and range low limit), decimal position, and unit data items are common SP and PV settings for the function block.

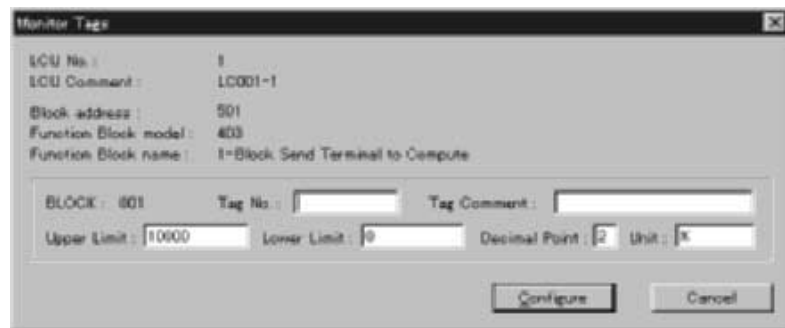

- Note**
1. For a 4-Block Send Terminal to Computer, four function blocks are selected for areas 1 through 4.
 2. The AO or DO to Computer or AO or DO Terminal to All Nodes Function Blocks cannot be registered in the CX-Process Monitor on a Tuning Screen.

AO or DO to Computer or AO or DO Terminal to All Nodes (Block Models 401/402 or 407/408)

Select the AO or DO to Computer or AO or DO Terminal to All Nodes, and then select **Tag Setting/Monitor Tag** from the Settings Menu. The following Monitor Tags dialog box will appear. Set the tag name and tag comment for the analog input ITEM or contact input ITEM. Input the scale (range high limit and range low limit), decimal position, and unit data items, and then click the **OK** Button.

Note The following symbols are used in the fields.

RH: Range high limit
 RL: Range low limit
 DP: Decimal position
 UNIT: Unit

Example for Analog Inputs

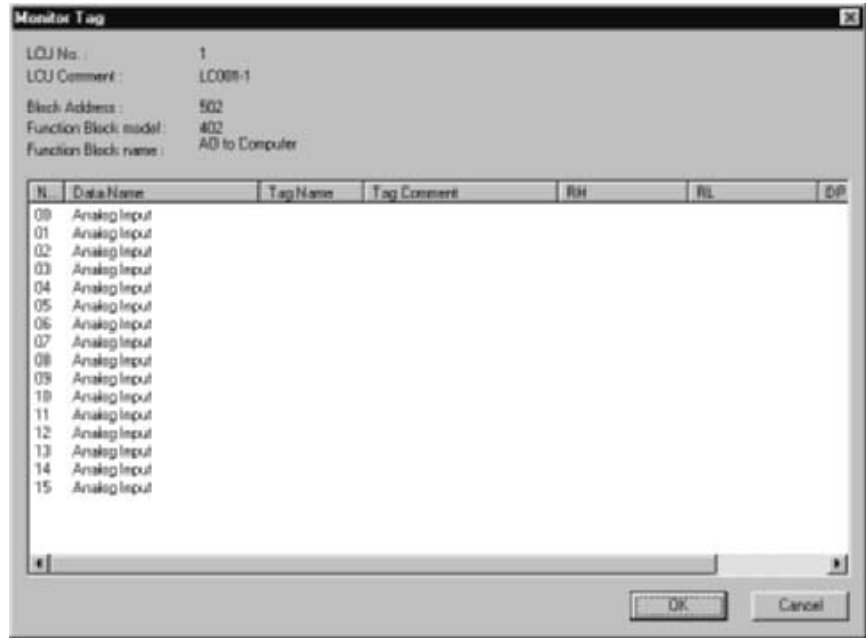

AO or DO Terminal Settings from Computer (Block Models 409/410)

Select AO or DO Terminal Settings from Computer, and then select **Tag Setting/ Monitor Tag** from the Settings Menu. The following Monitor Tags dialog will appear. Set the tag name and tag comment for the analog input ITEM or contact input ITEM. Input the scale (range high limit and range low limit), decimal position, and unit data items, and then click the **OK** Button.

Note The following symbols are used in the field.

- RH: Range High Limit
- RL: Range Low Limit
- DP: Decimal position
- UNIT: Unit

Example for Contact Inputs



- 1, 2, 3... 1. Select the number ITEM and double-click the Tag Name Field. The following Input Data Dialog Box will appear.



2. Input the tag name (along with a tag comment if necessary) and click the **OK** Button.

Note 1. It is imperative to input tag names. The CX-Process Monitor identifies the data using the tag names.

| Item | Maximum number of characters | Illegal characters |
|-------------|------------------------------|--------------------|
| Tag name | 8 standard-size characters | --- |
| Tag comment | 16 standard-size characters | --- |

Note It is possible to input the tag name automatically through the system by clicking **Input All**.

2. The following scaling is available on the CX-Process Monitor. Set the range high limit (RH) and range low limit (RL) within the specified range.

| | |
|-------------------------|---|
| Number of digits | 5 digits max. including sign and decimal digits |
| Numeric range | 5000 to 99999 Example: One decimal -550.0 to 9999.9 |

Compiling Monitor Tags

Note When CX-Server has been selected as the communications driver, set the node address to a non-zero value in the Change PLC Dialog Box before compiling the CSV tag file. Select **Change PLC** from the Settings Menu to display the dialog box. (If the computer is connected online, return the node address setting to 0.)

Provided that the CX-Process Monitor has been installed, monitor tags can be compiled for the CX-Process Monitor by taking the following steps.

- 1, 2, 3... 1. Select **Create Tag File – Monitor Tag** from the Execution Menu. The following dialog box will be displayed.

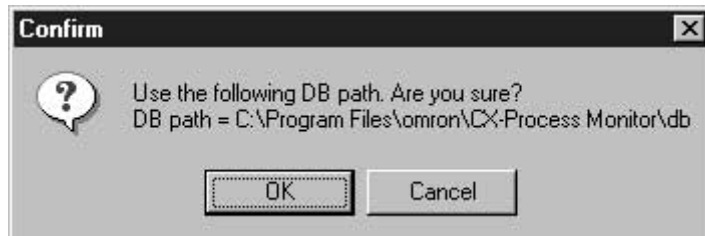

- Click the **OK** Button. The following Compile Monitor Tags Dialog Box will appear.



- Click the **Compile** Button. The result will be displayed in the Output Window as shown below.



- If the multi-node function block file is being compiled, click **Next Node** in the Compile Monitor Tags Dialog Box, and then repeat step 2, above.
- After the compilation, click **Exit** in the Compile Monitor Tags Dialog Box.

Note To check monitor tag duplication, click the **Check Overlapping** Button in the Compile Monitor Tags Dialog Box. The following Result Screen will appear.



- Note**
- It is necessary to install the CX-Process Monitor on the same personal computer before creating monitor tag files.
 - On completion of the above compilation, a monitor tag file with a fixed file name (for monitor tag data for the CPU Unit) will be created in the following folder: omron\CX-Process\Process Monitor\db (The underlined part is the folder of CX-Process Monitor.)
File names: mtagmst and mtagsubmst
 - Compile the monitor tag file again in any of the following cases.
 - The function blocks for data exchange with the CX-Process Monitor are changed (i.e., the source of the Block Send Terminal to Computer is changed).
 - The monitor tags are changed.
 - The network address, node address, or unit address is changed.

3-2-2 Validate the Monitor Tag List

You can display lists of the monitor tags for the LCU/LCB elements, function block files, or Project Workspace.

Note The data is displayed after the settings have been made. You can display the lists before or after compilation.

- 1, 2, 3... 1. Select the LCU/LCB element (default: LC001-1), function block file, or Project Workspace.
2. Select **Show Tag List – Monitor Tag** from the Execution Menu, or click the right mouse button and select **List – Monitor Tag** from the pop-up window. The following Monitor Tag List Dialog Box will be displayed.

The tag name that has been set for the data exchange function block with the block address for the current Loop Control Unit node address will be displayed.

| No | Net | Node | LCU | Block | TagBlock Type | Tag name | LinkedBlock | RH | RL | DP | Unit | Comment |
|----|-----|------|-----|-------|----------------------------|----------|---------------------|-------|----|----|------|---------|
| 1 | 1 | 1 | 16 | 501 | 403: 1-Block_Send_Terminal | Tag1 | 001(011: Basic PID) | 10000 | 0 | 2 | % | comment |

Serial No.
 Network address
 Node address (function block file)
 Unit No. address (Loop Control Unit)

Block address
 Block model
 Block name
 Tag name
 Linked Block address (model: name)

3-3 Using the CX-Process Monitor Plus

The following six steps must be performed on the CX-Process Tool to pass tag data to the CX-Process Monitor Plus.

- 1, 2, 3... 1. Set the network address, node address, and unit address.
2. Register and connect the function blocks that exchange data with the CX-Process Monitor Plus.
3. Set the CSV tags and the CX-Process Monitor Plus tags.
4. Generate the CX-Process Monitor Plus tag file.
5. Download the function block data to the Loop Controller.
6. Compile the monitor tag files.

Set Network Address, Node Address, and Unit Address.

The CX-Process Monitor Plus uses the network address, node address, and unit address set using the CX-Process Tool (**Settings/Network Settings** or **Settings/Change PLC**) for communications with the PLC. The communications settings for the CX-Process Monitor Plus and thus made from the CX-Process Tool.

Note The CX-Process Monitor and CX-Process Monitor Plus use FinsGateway as the communications driver for connections with the PLC. When using the CX-Process Monitor or CX-Process Monitor Plus, always set FinsGateway as the communications driver for the CX-Process Tool. If the CX-Server is set, the CX-Process Monitor or CX-Process Monitor Plus will not be able to go online with the PLC.

Register and Connect Function Blocks To Exchange Data with CX-Process Monitor Plus.

| Item | Loop Control Unit | LCB□□ |
|---------------------------------|--|--|
| Function block data to exchange | Send All Blocks block (Block Model 462) and Receive All Blocks block (Block Model 461) | HMI settings in the System Common block (Block Mode 000) |
| Contact signals to exchange | Contact Distributor (Block Model 201) or Internal Switch (Block Model 209) | |
| Analog signals to exchange | Input Selector block (Block Model 162) and Constant Generator block (Block Model 166) | |

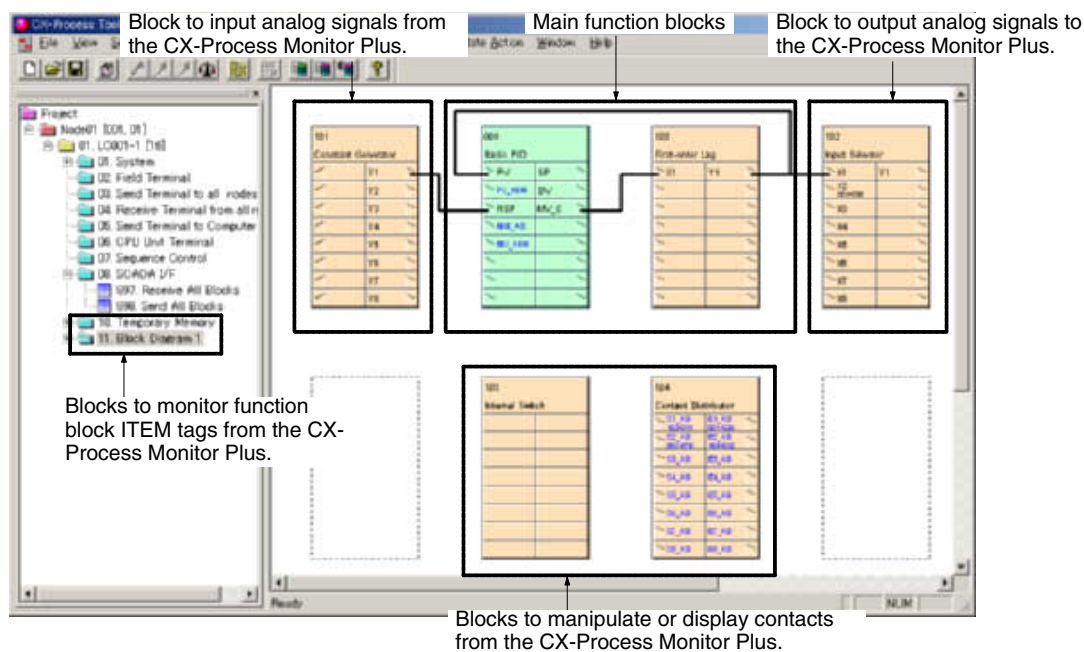

Set CSV Tags and CX-Process Monitor Plus Tags.

Always set the CSV tags and tags for the CX-Process Monitor Plus. The CX-Process Monitor Plus recognizes CSV tags and tags for the CX-Process Monitor Plus using tag names.

Example for Internal Switch Block (Block Model 209)

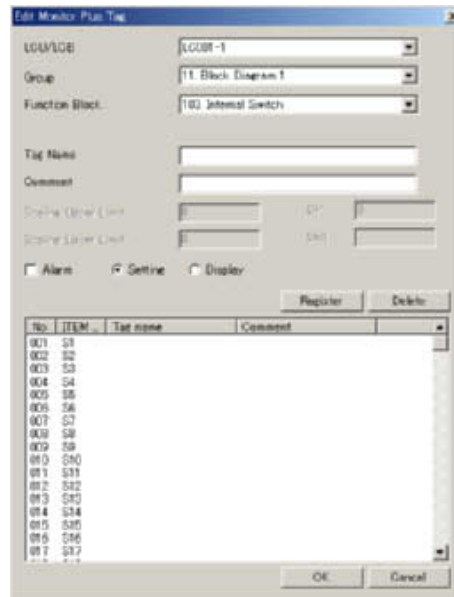

| Item | No. of character | Prohibited characters |
|--------------|------------------|-----------------------|
| Tag names | 16 max. | None |
| Tag comments | 16 max. | None |

Note Set the range upper limit (RH) and range lower limit (RL) for scaling on the CX-Process Monitor Plus to the range given in the following table.

| | |
|------------------|---|
| Number of digits | 5 max. including sign and decimal point |
| Numeric range | -5000 to 99999 Example with one digit below the decimal point: -550.0 to 9999.9 |

Generate CX-Process Monitor Plus Tag File.

Generate the CX-Process Plus tag file using the following procedure.

- 1, 2, 3... 1. Select **Execute - Create Tag File - Monitor Plus Tag**. The following window will be displayed. To execute an error check, select the option to perform an error check.

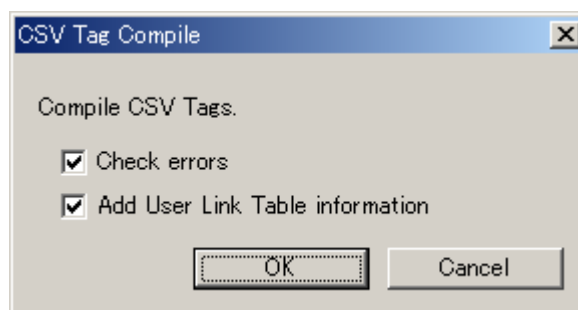

- Click the **OK** Button. Compilation of CSV tags and CX-Process Monitor Plus tags will begin. The following message will be displayed if compilation ends normally.

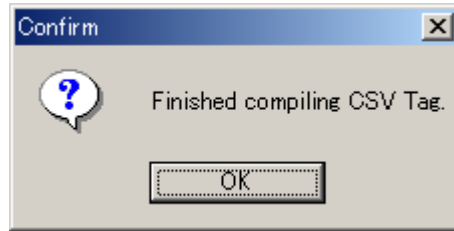

Note If a CX-Process Monitor Plus tag file is output while the CX-Process Monitor Plus is running, the following dialog box will be displayed.



Even if a CX-Process Monitor Plus tag file is output while the CX-Process Monitor Plus is running, the tag information will not be updated. To update the information, restart the CX-Process Monitor Plus.

Download Function Block Data to Loop Controller.

Download the function blocks.

Compile Monitor Tag Files.

The monitor tag file is generated by compiling the CX-Process Monitor tag file that was generated. The compilation process will automatically create the monitor tag files in the following folder.

Folder: Omron\CX-Process Monitor Plus\db (The underlined portion is the installation folder of the CX-Process Monitor Plus.)

File names: mtagmst and mtagsubmst

- 1, 2, 3...** Start the CX-Process Monitor Plus by selecting **Program - OMRON - CX-Process Monitor Plus - CX-Process Monitor Plus** from the Windows Start Menu.
- Click the **Start** Button. The monitor tag file will be compiled.

3-4 Using SCADA Software

3-4-1 Creating SCADA Software and RS View Tag Files

The following procedures are required to create tag files for SCADA software or the RS View.

- 1, 2, 3... 1. For Loop Control Units, register Send All Blocks (462) and Receive All Blocks (461) (and if required, Expanded CPU Unit Terminal or CPU Unit Terminal function blocks).
For LCB□□, set ITEMS related to the HMI functions in the System Common Block (000) (and register tags for user link tables as required).
2. Set CSV tags for each function block.

Note CX-Process Tool version 3.1 or higher supports automatic registration of CSV tags when function blocks are registered. The tag can also be edited in Excel or other software and then read into the project.

3. Compiling the CSV tag files.

The tag file for SCADA software (default: taglist.csv) and the tag file for RS View (*user_set_file_name.csv*) are used differently, as described next.

Tag Files for NS-series PTs

- 1, 2, 3... 1. Create the tag file for SCADA software (using **Execute – Create Tag File – CSV Tag**).
2. Import the file into the NS Face Plate Auto Builder.

Note CX-Process Tool version 4.0 or higher supports creating tag files for SCADA software (compiling CSV tags) and starting the NS Face Plate Auto Builder in one operation (using **Execute – Create Tag File – Start NSFP**).

Tag Files for RS View 32

Create the tag file for RS View 32 (using **Execute – Create Tag File – RS View Tag**). Import the tag file directly into RS View 32 using its import utility.

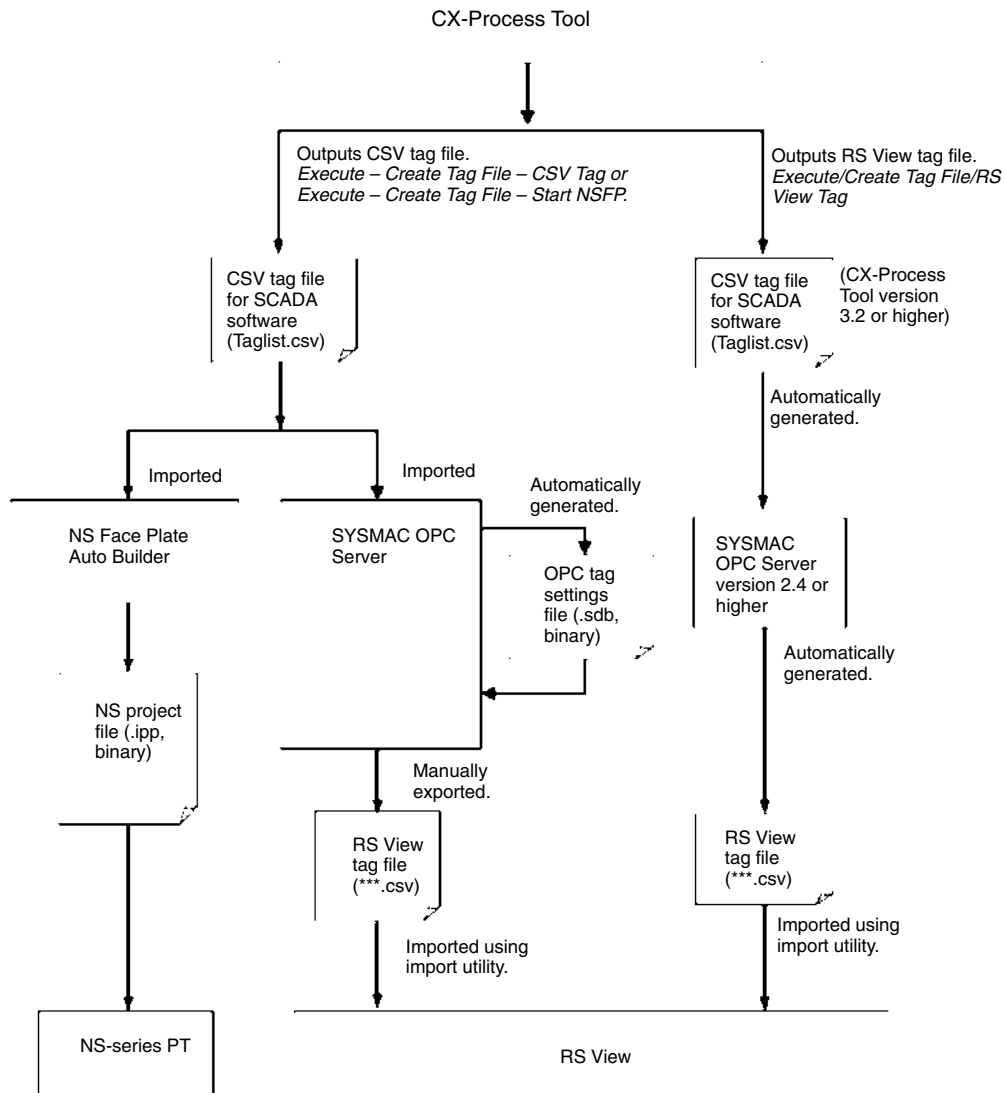

Note The CSV settings file (*project_name.csv*) is a data file automatically generated by the system to create a SCADA software or RS View tag file. In comparison, the SCADA tag file or RS View tag file is output based on the CSV settings file and contains the CPU Unit I/O memory allocations for each tag ITEM.

Expanded Scaling Data for SYSMAC OPC Server Version 2.6 (CX-Process Tool Version 4.0 or Higher Only)

Scaling functions have been expanded in SYSTEM OPC Server Version 2.6 and higher. The expanded scaling data enables scaling in engineering units using an OPC Server. Therefore, scaling settings in the SCADA software are not required. CX-Process Tool version 4.0 or higher is required to export CSV tags with expanded scaling data from the CX-Process Tool to SYSMAC OPC Server version 2.6. Expanded scaling data cannot be exported if lower versions of the CX-Process Tool are used.

Exporting Expanded Scaling Data

Use the following procedure to export CSV tags with expanded scaling data.

Step 1: Set Options

Select **Setting – Option**, and then select the **CSV Tag Setting** Tab to display the following window.



Select the **Show extended property** option. The meanings of the other options are as follows:

- **Always enable OPC Server scaling tag option**
Select to make outputting OPC Server scaling tags the default setting.
- **Treat User Link Table as OPC Server scaling tag**
Select to output scaling tags for CSV tags in the user link table. When selected, OPC Server scaling tags can also be output to CSV tag entries in the user link table.
- **Assume data range of ITEM related to MV to be 0-100%**
Select this option to set the data range's lower limit to 0.00% and upper limit to 100.00% for the three items MV (MV output value or manual MV during MAN mode), MH_LMT (high MV limit), ML_LMT (low MV limit) in the OPC Server.

Step 2: Select OPC Server Scaling Tag Output in CSV Tag Settings

Select the option for OPC Server scaling tag output in the CSV tag settings.

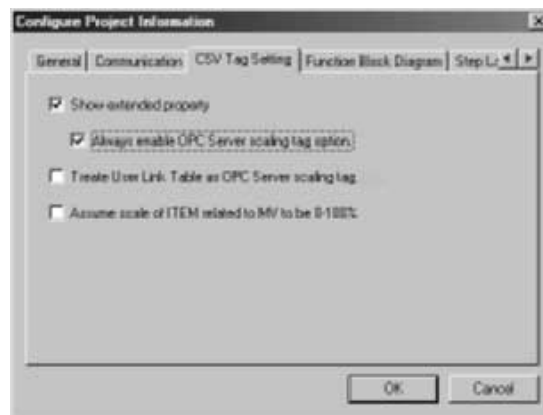

Step 3: Output Tag Files

Select **CSV Tag** or **RS View Tag** under **Create Tag File** in the Execute Menu.

OPC Server Direct Access

When using SYSMAC OPC Server version 2.5 or higher, the HMI area is not used. The SYSMAC OPC Server can be used directly to set and monitor all ITEMS in the following function blocks from SCADA software.

Function Blocks That Can Be Directly Accessed from the OPC Server

- Ramp Program (Block Model 155)

- Segment Program (Block Model 156)
- Segment Program 2 (Block Model 157)

Using OPC Server Direct Access

To directly access function blocks from the OPC server, the OPC Server direct access tags must be output to the SCADA tag file or the RS View tag file. Use the following procedure to output the OPC Server direct access tags.

- 1, 2, 3...
1. Select **Setting – Option**.
 2. Select the *Enable OPC Server direct access tag* option on the *General Tab Page*.

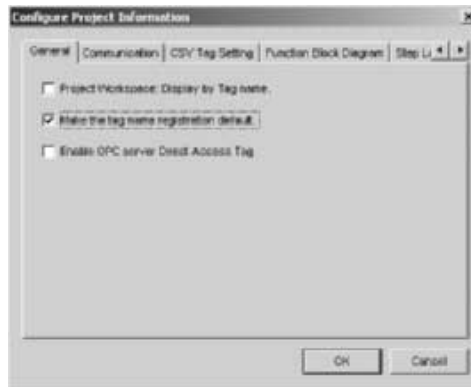

3. Select **Execute – Create Tag File – CSV Tag** or **Execute – Create Tag File – RS View Tag**. The SCADA or RS View tag file will be output.

Creating SCADA Software and RS View Tag Files

Step 1: Registering Function Blocks to Exchange Data with SCADA Software

Loop Control Units: Register Send All Blocks (462) and Receive All Blocks (461) (and if required, Expanded CPU Unit Terminal and CPU Unit Terminal function blocks).

LCB□□: Set ITEMS related to HMI functions in the System Common Block (000) and register tags for user link tables as required.

Loop Control Units: Send All Blocks (462) and Receive All Blocks (461) function blocks must be registered together. Expanded CPU Unit Terminal and CPU Unit Terminal function blocks can be registered as required for ITEMS not handled by Send All Blocks (462) and Receive All Blocks (461) function blocks.

To set CSV tags for an ITEM that cannot be set with the CSV tag settings, register the Expanded CPU Unit Terminal or CPU Unit Terminal function blocks and input/output the ITEM.

Note With Loop Control Units, a CSV tag file cannot be compiled unless both Send All Blocks (462) and Receive All Blocks (461) function blocks are registered.

For LCB□□, set System Common Block (000) ITEM 059 (HMI Function Disable Switch), ITEM 050 (EM Area Bank Allocated for HMI Function), and ITEM 051 (Operation Cycle for HMI Function). To set CSV tags for any other ITEM, register the tags in the user link table and input/output the ITEM.

Step 2: Setting CSV Tags

Set the CSV tags for each function block as described below. CSV tags can be set for the following function blocks.

- Loop Control Units: Control blocks, operation blocks (except for Contact Distributor (201) and default registration TR internal switches), External

Controller Terminal Blocks, CPU Unit Terminal Blocks, and Expanded CPU Unit Terminal Blocks.

- LCB□□: System Common Blocks, control blocks, operation blocks (except for Contact Distributor (201) and default registration TR internal switches), External Controller Terminal Blocks. (External Controller Terminal Blocks cannot be used with the CS1D-LCB05D.)

With CX-Process Tool software version 3.1 or higher, either of the following two methods can be used to set CSV tags. (Method b is possible only for version 3.0 and lower.)

- Setting the tags individually using the CSV Settings Dialog Box.cc
- Editing with Excel after automatic registration.

After the CSV tags have been set using either of the above methods, compile the CSV tag files for SCADA software and use those files with SCADA software, PTs, etc.

Setting Tags Individually Using the CSV Settings Dialog Box

Use the procedure shown in the following flow diagram.

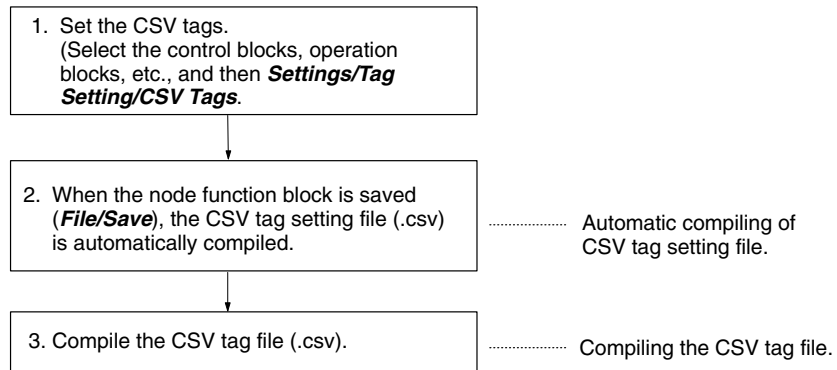

- 1, 2, 3...**
1. Select the block for which CSV tags are to be set and then select **Tag Setting/CSV Tags** from the Settings Menu. The following dialog box will appear.



2. Set the tag name, scaling upper/lower limits, unit, and other information for the function block. The same scaling upper/lower limits, decimal point position, and unit setting are used for all of the SP, PV, and other ITEMS in the function blocks.
3. Click the **Configure** Button.

The settings required for CSV tags are listed in the following table.

| Setting | Setting range |
|--|--|
| Tag name (representative tag) | 16 characters max. (All characters can be used.) |
| Tag Comment | 16 characters max. (All characters can be used.) |
| Upper Limit | -5,000 to 99,999 (e.g., if decimal point is set to 1: -550.0 to 9,999.9) |
| Lower Limit | -5,000 to 99,999 (e.g., if decimal point is set to 1: -550.0 to 9,999.9) |
| Decimal Point (number of digits below decimal point for scaling) | 0 to 9 |
| Unit | 8 characters max. (All characters can be used.) |

Note When the node function block is saved, a CSV setting file (named *project_name.CSV*) is automatically stored with the following data added to the user-set data.

| Setting | Setting range |
|------------------|---------------|
| Network address | 0 to 127 |
| Node address | 0 to 32 |
| Unit address | 16 to 31, 255 |
| Block model | 0 to 1000 |
| Block address | 0 to 1000 |
| Block model name | --- |

Note When CX-Server has been selected as the communications driver, the node address must be set to a non-zero value before compiling the CSV tag file.

Note Always set tag names. SCADA software uses these to identify data.

Editing with Excel after Automatic Registration

Use the procedure shown in the following flow diagram.

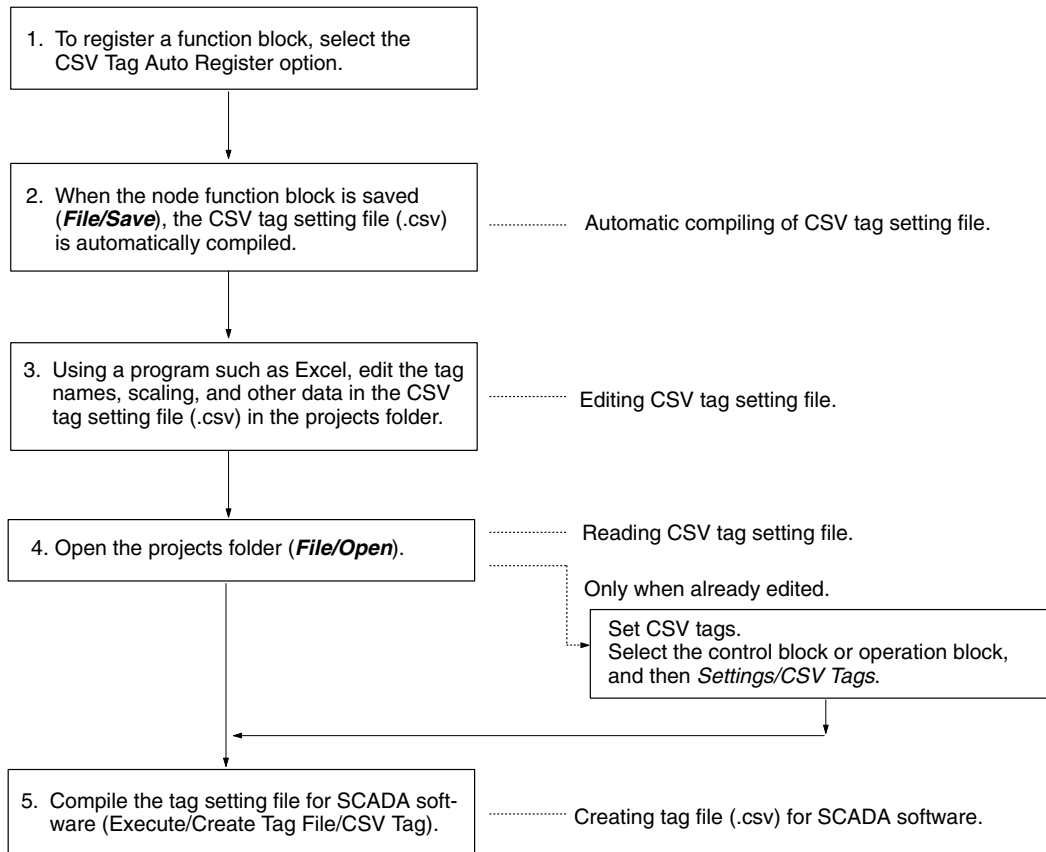

Use the following methods.

- 1, 2, 3...** 1. When registering function blocks, such as Control Blocks or Operation Blocks, for which CSV tags can be set, select the CSV Tag Auto Register option as shown in the following illustration. (Clear the option if the function block is not to be registered.)

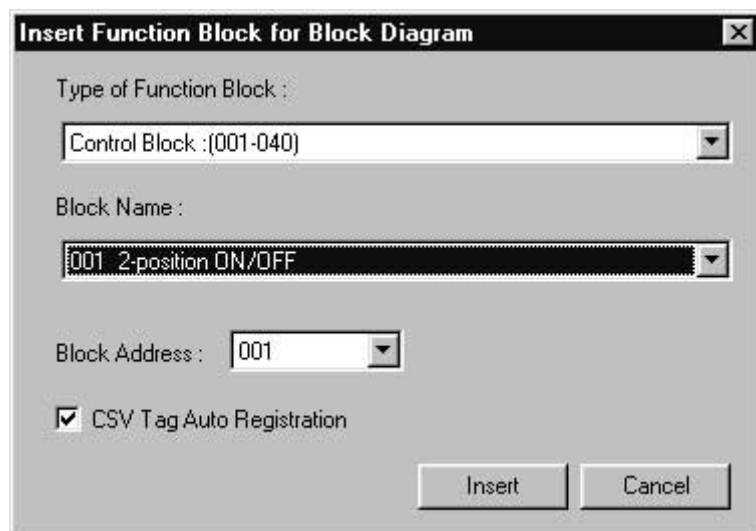

Note The above automatic registration of CSV tag settings is executed at the following times: Function block insertion, function block pasting (small item pasting when middle block is selected), or block diagram pasting.

- When the node function blocks are saved, a CSV setting file with the following contents (*project_name.csv*) is automatically created in a folder with the project name, under CX-Process Tool/data.

| Settings | Data set for automatic CSV tag registration | |
|---|--|---|
| Tag name (representative tag) | Tag□□□ (□: Function block No.) | |
| Tag comment | Blank | |
| Scaling upper limit | 10,000 (Note: 0 for internal switches) | |
| Scaling lower limit | 0 | |
| Decimal point position (number of digits below decimal point for scaling) | 2 (Note: This will be 0 for Operation Blocks and internal switches other than upper and lower limit alarms and deviation alarms.) | |
| Unit | Blank | |
| Network address | 0 to 127 | The contents of registered function blocks are automatically reflected. |
| Node address | 0 to 32 | |
| Unit address | 16 to 31, 225 | |
| Block model | 0 to 1,000 | |
| Block address | 0 to 1,000 | |
| Block model name | <i>Name</i> | |

- Open and edit the CSV setting file (*project_name.csv*) using a spreadsheet program, such as Excel.

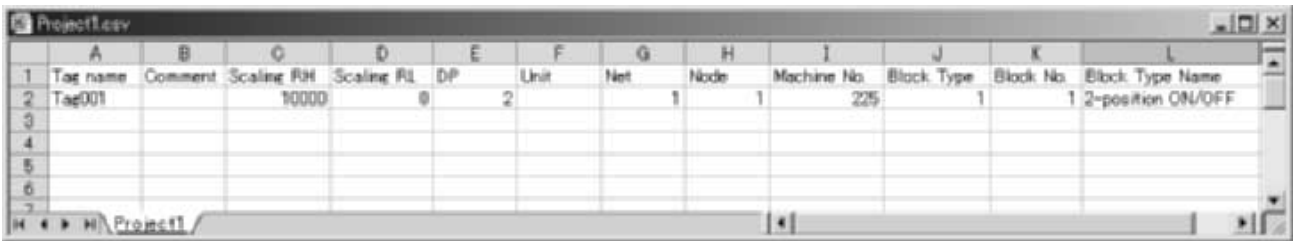

Edit the tag names (representative tags), scaling upper and lower limits, decimal point positions, and units as shown in the following illustration.

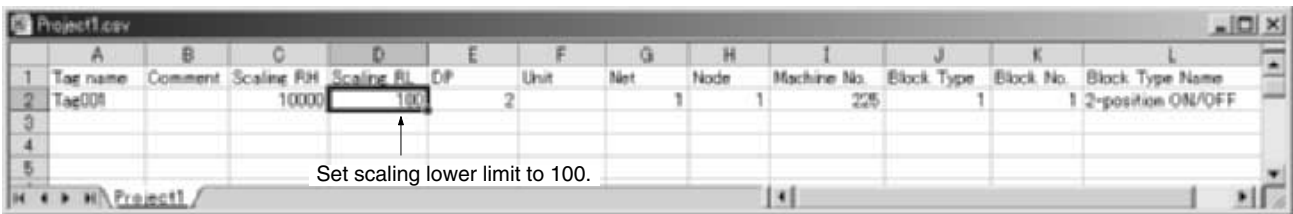

| Setting | Setting range |
|--|--|
| Tag name (representative tag) | 16 characters max. (All characters can be used.) |
| Tag comment | 16 characters max. (All characters can be used.) |
| Scaling upper limit | -5,000 to 99,999 (e.g., if decimal point is set to 1: -550.0 to 9,999.9) |
| Scaling lower limit | -5,000 to 99,999 (e.g., if decimal point is set to 1: -550.0 to 9,999.9) |
| Decimal Point (number of digits below decimal point for scaling) | 0 to 9 |
| Unit | 8 characters max. (All characters can be used.) |
| Network address | 0 to 127 |
| Node address (See note 1.) | 0 to 32 |
| Unit address | 16 to 31, 225 |
| Block model | 0 to 1,000 |
| Block address | 0 to 1,000 |
| Block model name | Input automatically. |

- Note**
- When the CX-Server is selected, the node address must be set to a number other than 0 before compiling the SCADA software CSV tag file.
 - Always set tag names. SCADA software uses these to identify data.
- Save the filename, extension, and folder position just as they are.
 - Open the Project again. The editing results will be automatically reflected in the CSV tag list. The CSV tag list is displayed by selecting **Show Tag List/CSV Tag** from the Execution Menu.
 - As required, use the setting method provided under *Setting Tags Individually Using the CSV Settings Dialog Box* on page 145 to individually edit the function block CSV tags.

Step 3: Checking CSV Tags

Check the CSV tag settings by selecting **Show Tag List/CSV Tag** from the Execution Menu. The following dialog box will be displayed.

| No | Tagname | Comment | Net | Node | No | Blo | Block Type | Scaling RH | Scaling RL | DP | Unit |
|-------|---------|---------|-----|------|-----|-----|-----------------------|------------|------------|----|------|
| 00000 | OTHER | | 1 | 1 | 225 | 009 | 011 - Model Basic PRO | 10000 | 0 | | 2 |

Step 4: Creating SCADA Software or RS View Tag Files (Compiling)

Compile the CSV tag file or the RS View tag file using the following procedure after setting the CSV tags.

- Note** When CX-Server has been selected as the communications driver, set the node address to a non-zero value in the Change PLC Dialog Box before compiling the CSV tag file. Select **Change PLC** from the Settings Menu to display the dialog box. (If the computer is connected online, return the node address setting to 0.)

The following conditions must be met to compile the SCADA or RS View tag file:

- 1) CSV tags must be set for Control, Operation (except internal switches), and External Controller Terminal Blocks, and both Send All Blocks (462) and Re-

ceive All Blocks (461) must be registered for Loop Control Units and 2) CSV tags must be set for any Expanded CPU Unit Terminal function blocks for Loop Control Units.

Creating SCADA Tag Files

- 1) Select **Compile CSV Tags** from the Execution Menu. The following dialog box will be displayed.



If **Check Errors** is selected and the **OK** Button is clicked, the results of the error check will be displayed when the file is compiled.

To add user link table tags to the CSV tag file for LCB□□s, select **Add User Link Table Information**.

- 2) Click the **OK** Button. The execution results will be displayed in the Output Window.

Error Display

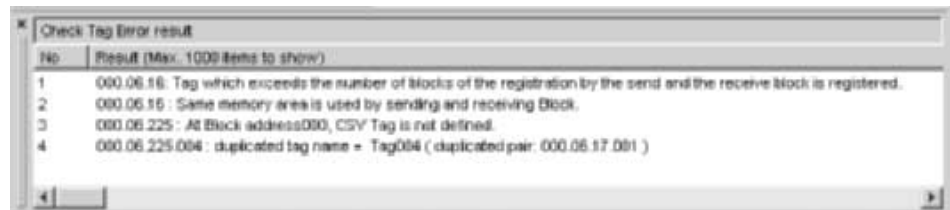

The following dialog box will be displayed for confirmation.

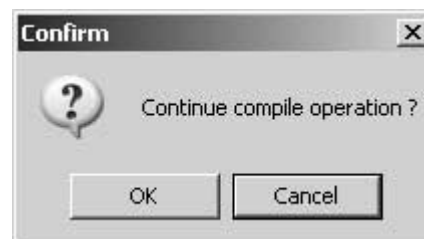

Click the **Cancel** Button and correct the error. (For example, if the message says a CSV tag is not registered for a certain block address, register the CSV tag.)

If the **OK** Button is pressed even though there is an error, the same dialog box as for when no error occurs will be displayed.

The following window will be displayed if there are no errors.



- 3) Set the folder and name for the CSV tag file and click the **Save** Button. The following dialog box will appear if CSV tag file was compiled correctly.



- 4) Click the **OK** Button.

Creating RS View Tag Files

- 1, 2, 3... 1. Select **Compile CSV Tags** from the Execution Menu. The following dialog box will be displayed.

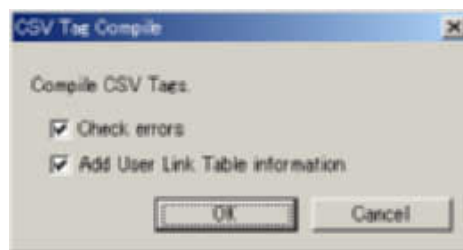

If **Check Errors** is selected and the **OK** Button is clicked, the results of the error check will be displayed when the file is compiled.

- Note**
- a) When adding user link table tags to the RS View tag file, select the option to output CSV tag information in either the Edit User Link Table Dialog Box or the User Link Table Batch Registration Dialog Box when registering the user link table and then enable adding user link table information when compiling.
 - b) If a user link table is created without enabling outputting CSV tag information, the user link table tags will not be output even if adding user link table information is selected.

2. Click the **OK** Button. The results will be displayed in the Output Window.

Error Display

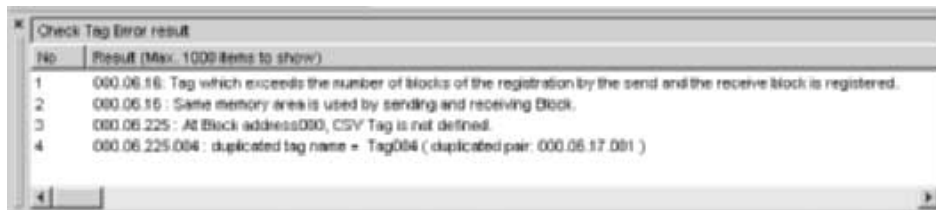

Normal Display



3. Set the folder and name for the tag file and click the **OK** Button. The following RS View Tag Compile Dialog Box will appear.

The dialog box is titled "RS View Tag Compile" and contains several sections:

- Data for Creating RS View Input Tag:** Includes a checked checkbox for "CX-Process Tool: Tag information (*.csv)", a file path field, a checked checkbox for "Set Representative Tag to OPC Server Group", and an unchecked checkbox for "CX-Programmer: Add Symbols".
- OPC tag file name (*.sdb):** A file path field.
- CSV File for RS View Input:** Includes a checked checkbox for "CSV file for RS View (*.csv)", a file path field, a "Node Name" field with "Node01", a "File Type" dropdown menu with "Tag + Min/Max + Unit", a checked checkbox for "Group Hierarchy" with a value of "5", a checked checkbox for "Convert Array", and an unchecked checkbox for "Convert Integer to Real".
- Force scaling data range to 0-100%:** An unchecked checkbox.
- Specify Remote Server (Machine Name or IP Address):** A text field.

Callout lines from the text on the right point to these specific elements in the dialog box.

When specifying a SCADA tag file (Taglist.csv) for compilation, select this option and specify the SCADA tag file.

If this option is selected:
The OPC Server group name will be the same as the CSV tag file tag name (representative tags) and the OPC Server tag name will be the same as the CSV tag file ITEM tag name.

If this option is not selected:
The OPC Server tag name will be the same as the CSV tag file tag name (representative tags) and the ITEM name will be added after an underscore.

Select this option to add the symbol information for the symbols for all local symbol tables in the current CXP project for CX-Programmer running on the same computer.

Specify the location for automatic generation of the OPC tag settings file (.sdb) (the OPC Server binary file).

Specify the output folder and file name for the RS View tag file. Use the file specified here to import the CX-Process Tool tags to the RS View 32 tag data base. Use the Database Import and Export Wizard to execute the import operation.

Specify the node name set for the OPC Server in the RS View 32 project.

Specify the type of file to output.
Tag: Tag data only
Tag + Min/Max + unit: Tag data plus additional information (See note.)

Note The additional information includes scaling information (scaling upper/lower limits and decimal point position), units, and data range upper/lower limits (calculated using scaling information).

Specify the group level. If a level is not specified, all tags will be output. Tags in groups beyond the specified group level will not be output.

Specify process when array data is being output.

Select this option to convert integer data on the OPC Server to the default data type (real) on the RS View 32.

Select this option to disable data in the OPC Server between +115% and 100% and between -15% and 0%. This option treats data in the range +115% to 100% as 100% and data in the range -15% to 0% as 0%.

For example, the data range for PID function block item HH is -15.00 to +115.00, but data in the range +100% to +115% and -15% to 0% will be ignored and only data between 0% and 100% will be used.

Select this option when compiling an RS View tag file that is saved on a remote OPC Server, i.e., a OPC Server on the network. Input the computer name and IP address of the remote server.

This option is used when there is no OPC Server installed on the local computer or when all information management is being performed on one OPC Server.

To use this option, any RS View tag file output on the local computer must be transferred to the remote server. A file on a client cannot be compiled by the remote server. Refer to the *SYSMAC OPC Server Operation Manual* for information on designating remote servers.

Note Specify the data settings for tag compilation, the OPC tag file name, and the file name for creating the RS View CSV tag file using absolute paths on the remote server.

4. The following dialog box will appear if tag file was compiled correctly.

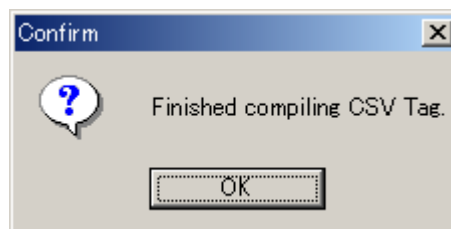

5. Click the **OK** Button.

Note OPC server direct access tags can also be added to the RS View tag file. The procedure is basically the same as when added OPC server direct access tags to SCADA tag files.

The following flowchart shows all the operations involved in using RS View32 to specify an ITEM in the Loop Controller.

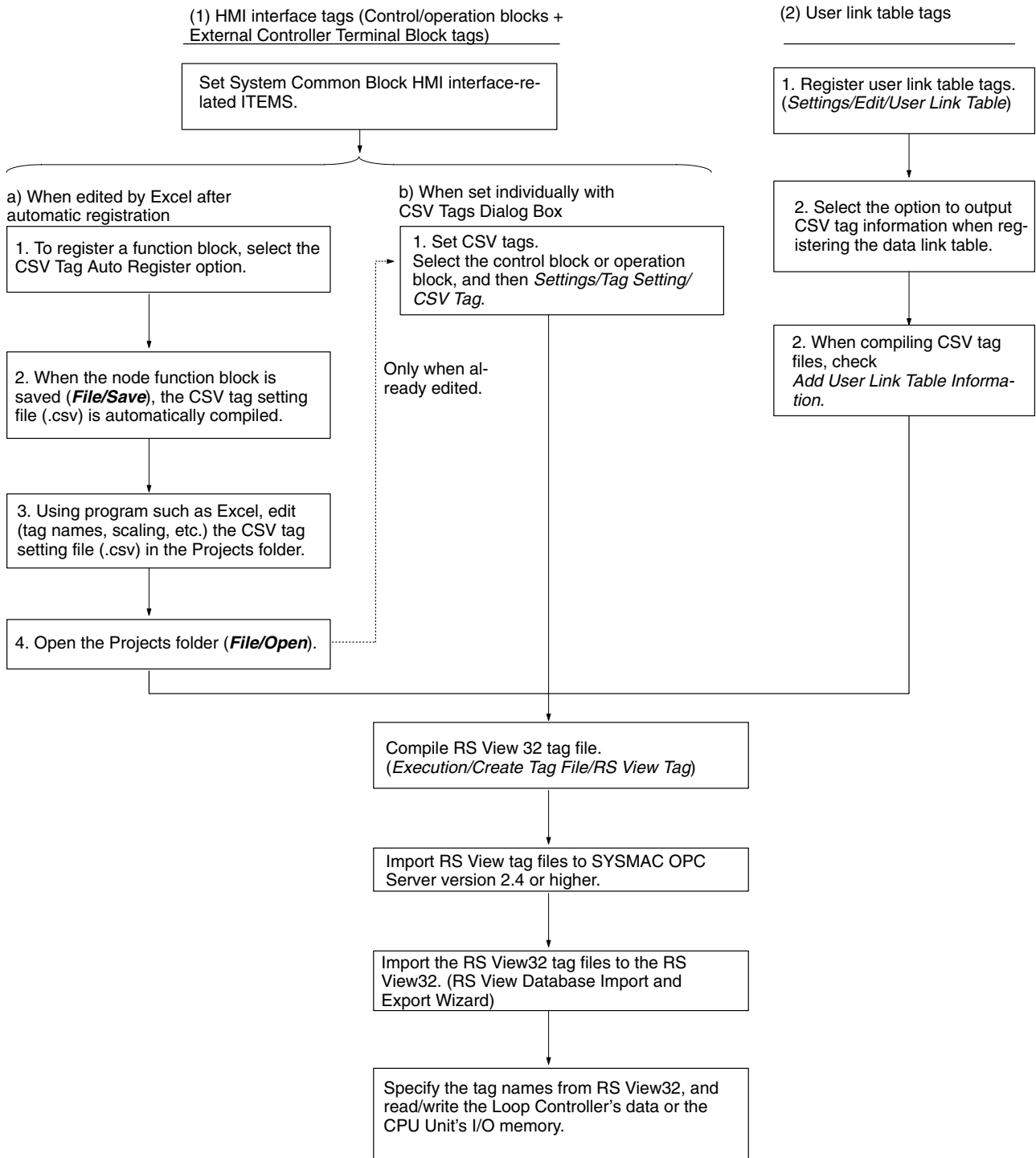

Contents of SCADA Tag Files, Including OPC Server Direct Access Tags

The contents of the CSV tag file is listed in the following table. The file is a tab-delimited text file in the same order as the table, and it can be read with spreadsheet software. A CSV tag file can be imported to an OPC server, tag names and tag ITEMS can be specified from RS View or other SCADA software on the OPC server, and then the data can be written to or read from the Loop Controller.

| Contents | Setting range for ITEMS | | |
|--------------------------------------|--|--|--|
| | HMI tags | User link table tags | OPC Server direct access tags |
| Record number | 1 to 65535 | | |
| Function block file name | Max. 6 characters | | FDAC + node number |
| LCU/LCB element name | LCB05, LCB01, LCB03, LCB05D, LC0011, LC0012, LC0013 | LCB05, LCB01, LCB03, LCB05D | LCB05, LCB01, LCB05D, LC0011, LC0012, LC0013 |
| Tag name (representative tag) | 16 characters max. (Unusable characters: None) | Always LNK | 16 characters max. (Unusable characters: None) |
| Tag ITEM | Fixed for each function block item | Tag name from user link table | Fixed for each function block item |
| Tag comment | 16 characters max. (Unusable characters: None) | Tag comment from user link table, 23 characters max. (Unusable characters: None) | 16 characters max. (Unusable characters: None) |
| Tag type | 0: Analog, 1: Contact | | |
| Data attribute (See note 1.) | 1: Integer, U: Unit, 0: Contact | | 0: Contact, B: 1-byte data, U: UINT, I: INT |
| Contact alarm tag | 0: Normal, 1: Alarm | 0 | 0 |
| Scaling upper limit | -5000 to 99999 (Example for DP position of 1: -500.0 to 9999.9) | | -5000 to 99999 (Example for DP position of 1: -550.0 to 9999.9) |
| Scaling lower limit | -5000 to 99999 (Example for DP position of 1: -500.0 to 9999.9) | | -5000 to 99999 (Example for DP position of 1: -550.0 to 9999.9) |
| Decimal point position (for scaling) | 0 to 9 | | 0 to 9 |
| Unit | Max. 8 characters (Unusable characters: None) | | Max. 8 characters (Unusable characters: None) |
| Data range upper limit | -340680 to 330779 (When scaling $\pm 320\%$ data with an upper limit of 99999 and a lower limit of -5000) | 65535 (Fixed) | -5000 to 99999 |
| Data range lower limit | -340680 to 330779 (When scaling $\pm 320\%$ data with an upper limit of 99999 and a lower limit of -5000) | -32768 (Fixed) | -5000 to 99999 |
| Network address | 0 to 127 | | |
| Node address | 1 to 32 | | |
| Unit address | 16 to 31, 225 | 225 | 16 to 31, 225 |
| I/O memory area | 0: CIO, 1: W, 2: H, 3: D, 4: E0, 5: E1, 6: E2 ..., 15: EB, 16: EC | | Always 99 |
| I/O memory address | 0 to 65535 | | 0 |
| Bit position | 0 to 15 | | 0 |
| Function block model | 0 to 999 | -1 | 0 to 999 |
| Block address | 0 to 999 | -1 | 0 to 999 |
| ITEM number | 0 to 999 | -1 | 0 to 999 |
| Offset (write data) | ± 32767 0: Same address for read and write, Not 0: Read address + offset | 0 | |

| Contents | Setting range for ITEMS | | |
|--|-----------------------------------|--|-----------------------------------|
| | HMI tags | User link table tags | OPC Server direct access tags |
| Read/write | R: Read, RW: Read/write, W: Write | R: Read, W: Write Read and write are from the viewpoint of the SCADA software. If the tag is set for reading from the CPU Unit (to the Loop Controller), it will be write data from the SCADA software. If the tag is set for writing to the CPU Unit (from the Loop Controller), it will be read data from the SCADA software. | R: Read, RW: Read/write, W: Write |
| Upper limit for range conversion | 0 | -32000 to 32000 | 0 |
| Lower limit for range conversion | 0 | -32000 to 32000 | 0 |
| Expanded scaling setting (See note 3.) | 0: Disabled 1: Enabled | Same as HMI interface tags. | |

- Note**
1. Data attributes and contact alarm tags are used mainly by the OPC Server.
 2. The offset is stored when there are both write and read ITEM numbers in the Loop Controller. If the CPU Unit's I/O memory address is the same for both reading and writing, the offset will be 0. If they are different, the value of the write address minus the read address will be stored.
 3. Expanded scaling data can be exported only when using CX-Process Tool version 4.0 or higher.

LCU/LCB Properties and CSV Tag Files for the SYSMAC OPC Server

The relationship between LCU/LCB properties and CSV tag files for the SYSMAC OPC Server is shown in the following table.

| LCU/LCB property | CSV tag file | CSV tag file column |
|--------------------------|--|---------------------|
| | | Contact alarm tags |
| Scaling upper limit | Scaling upper limit value | 10 |
| Scaling lower limit | Scaling lower limit value | 11 |
| DP position | DP position | 12 |
| Unit | Unit | 13 |
| Data range upper limit | Data range upper limit value | 14 |
| Data range lower limit | Data range lower limit value | 15 |
| Function block FP number | Block mode. | 22 |
| Block address | Block address | 23 |
| ITEM number | ITEM number | 24 |
| Pre-scaling upper limit | Range conversion upper limit value (See note.) | 27 |
| Pre-scaling lower limit | Range conversion lower limit value (See note.) | 28 |

- Note** Can be changed only when outputting CSV tag information is selected when registering user link tables. For tags other than those for user link tables, default values are set (range conversion upper limit: 10,000, lower limit: 0).

3-4-2 CSV Output Function for HMI Data Allocation Status

With CX-Process Tool version 3.2 or higher, the allocation status of HMI data can be output in CSV format. Allocation status shows the EM Area addresses allocated to each tag/tag ITEM.

- Note**
1. User link table tags are not included.
 2. The maximum number of lines is 65,535.

Procedure

Select **Execute – Create Tag File – Create HMI I/F Memory Map**. The CSV tags will be compiled and the CSV tag file will be saved in a file of the specified name (default: HMI_IFMap.csv).

Data Format

Analog Data

```
<tag_name>_<ITEM_tag_name>,<INT or UNIT>,  
<allocated_EM_bank_number>_<address>,<comment>
```

Tag010_P,UINT,E5_89,Basic PID tag

Tag010_I,UINT,E5_90,Basic PID tag

Tag010_D,UINT,E5_91,Basic PID tag

Normal Contact Data

```
<tag_name>_<ITEM_tag_name>_<bit_position>,<BOOL>,  
<allocated_EM_bank_number>_<address>,<comment>
```

Tag010_R/L_SW_Bit00,BOOL,E5_98,Basic PID tag

Tag010_A/M_SW_Bit01,BOOL,E5_98,Basic PID tag

Tag010_AOF_Bit02,BOOL,E5_98,Basic PID tag

- Note** If the option to use the CX-Programmer symbol table format is selected, the data will be saved in a CSV file in a format that can be pasted into a CX-Programmer symbol table.

Contact Data in CX-Programmer Symbol Table Format

```
<tag_name>_<ITEM_tag_name>_<bit_position>,<INT>,  
<allocated_EM_bank_number>_<address>,<comment>
```

Tag010_RL_SW_Bit00,INT,E5_98,Basic PID tag

Tag010_AM_SW_Bit01,INT,E5_98,Basic PID tag

Tag010_AOF_Bit02,INT,E5_98,Basic PID tag

- The ITEM name will be deleted if it contains a slash (/).
- All BOOL data will be converted to INT data.

3-4-3 Other Interfaces with HMI

Starting Face Plate Auto-Builder for NS

Outline

From CX-Process Tool version 4.0, the Face Plate Auto-Builder for NS (NSFP) can be started in the sequence of operations when compiling CSV tags.

- CX-Process Tool Version 3.2 or Lower

The CSV tags were compiled in advance using CX-Process Tool, and then after starting the NSFP, the folder path for the previously saved CSV tag file had to be specified in the parameter setting screen.

- CX-Process Tool Version 4.0

NSFP can be automatically started after CSV tag files are compiled by selecting Create Tag File Start NSFP from the Execute Menu. Using this method, the folder path to the CSV tag file that has been created is automatically specified in the parameter settings screen that is displayed when the NSFP starts.

- Note** For details on NSFP, refer to the *Face Plate Auto-Builder for NS Operation Manual* (W418).

Procedure for Starting Face Plate Auto-Builder for NS (NSFP)

- 1, 2, 3...**
1. Install NSFP version 2.0 or higher in the personal computer beforehand.
 2. Set the CSV tags for each function block using the CX-Process Tool.
 3. Select Create Tag File Start NSFP from the Execute Menu, or click the  icon in the toolbar.
 4. CSV tags will be compiled.
 5. When the tag compilation has been completed normally, the NSFP will start automatically.
 6. The path to the CSV tag file created in step 4 will be automatically specified in the CSV Tag File field in the NSFP parameter settings screen.

Note This function requires NSFP version 2.0 or higher.

3-5 User Link Tables

3-5-1 Overview

User link tables are used to exchange data between a Loop Controller and the CPU Unit. User link tables cannot be used with Loop Control Units. A user-defined tag name and conditions for data exchange with the CPU Unit are set for each row of the table. For each tag name, the specified I/O memory locations in the CPU Unit are read and written according to the specified conditions. Up to 2,400 tags can be created.

Tags are registered in the user link table using the CX-Process Tool. Once tags have been registered in a user link table, they can be used in line connections, sequence tables, and other programming in the Loop Controller without having to specify specific I/O memory addresses.

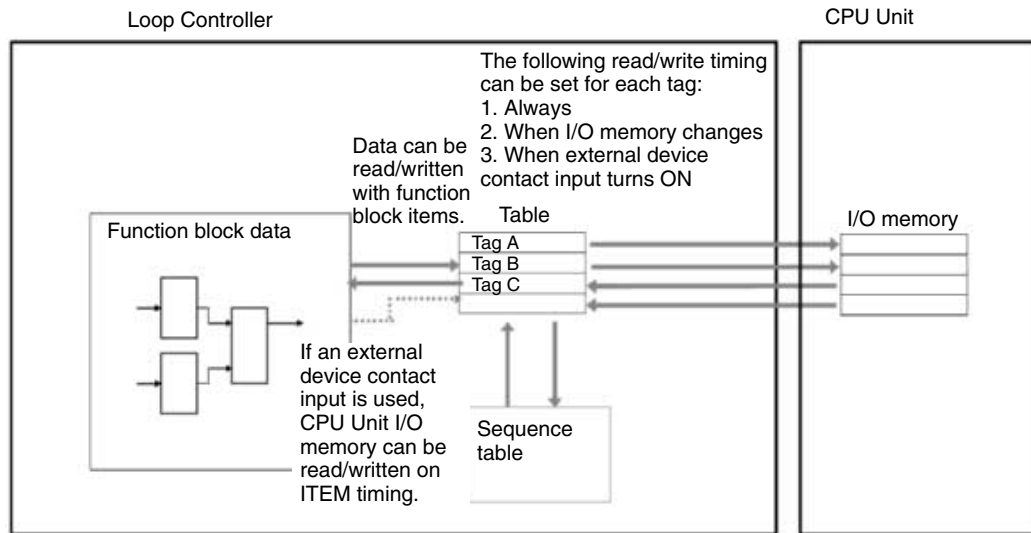

User link tables can also be pasted as virtual blocks on block diagrams. Also, tags can be automatically registered in user link tables when a field terminal block is pasted and software connections are made. (Select **Settings/Option** and then select the **Register Tag Name automatically when connected to Field Terminal** option on the User Link Table Tab Page.)

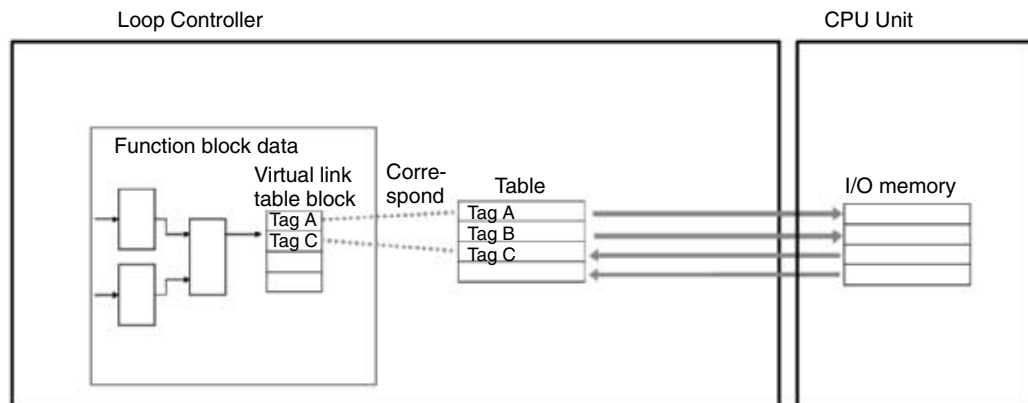

Note User link table tags can be saved in CSV format. They can thus be used in SCA-DA software to specify user link table tags to read and write I/O memory in the CPU Unit. (If **Add User Link Table Information** is selected in the CSV Tag Compile Dialog Box, the user link table tags will be appended after the normal HMI CSV tags.)

 **WARNING** Do not allow the area to which user link table data is written to overlap with any other area used by the CPU Unit or other Units. If areas overlap, the system may operate in an unexpected manner, which may result in injury. When using a user link table to write bit data to I/O memory in the CPU Unit. Never allow ladder programming or communications processes in the CPU Unit to write to any bits in the words in which bits are written from a user link table. Depending on the timing, any attempts to write to these words from ladder programming or communications processes may be ignored. Example: If tag A in a user link table writes to bit 00 of W000 and an OUT instruction in the ladder program in the CPU Unit write to bit 01 of W000, the write from the ladder program may be ignored.

 **Caution** Confirm the status of connected devices before transferring the setting for the MV tight shut function and MV analog output reverse function to the Loop Controller. Devices and equipment may perform unexpected operations if the data destination is mistaken.

3-5-2 Creating User Link Tables

Use one of the following methods to create a user link table.

- Method 1: Registration on the User Link Table Edit Screen
- Method 2: Registration from the Block Diagram
- Method 3: Batch registration on the User Link Table Edit Screen
- Method 4: Automatic Registration when Pasting Field Terminal Block and Creating Software Connections

- 1, 2, 3...**
1. Method 1: Registration on the User Link Table Edit Screen
 - 1) Select **Edit/User Link Table** from the Settings Menu.
 - 2) Right-click on the User Link Table Edit Screen and select **Add** from the pop-up menu.
 2. Method 2: Registration from the Block Diagram
 - 1) Right-click on the block diagram and select **Register/User Link Table/Link Input (Read from CPU Memory)** or **Register/User Link Table/Link Output (Write to CPU Memory)** from the pop-up menu. A user link table block will be created.
 - 2) Select the block that was created, right-click, and select **Register/User Link Table/Register Block Cell** from the pop-up menu.

The following dialog box will be displayed for either method 1 or 2.

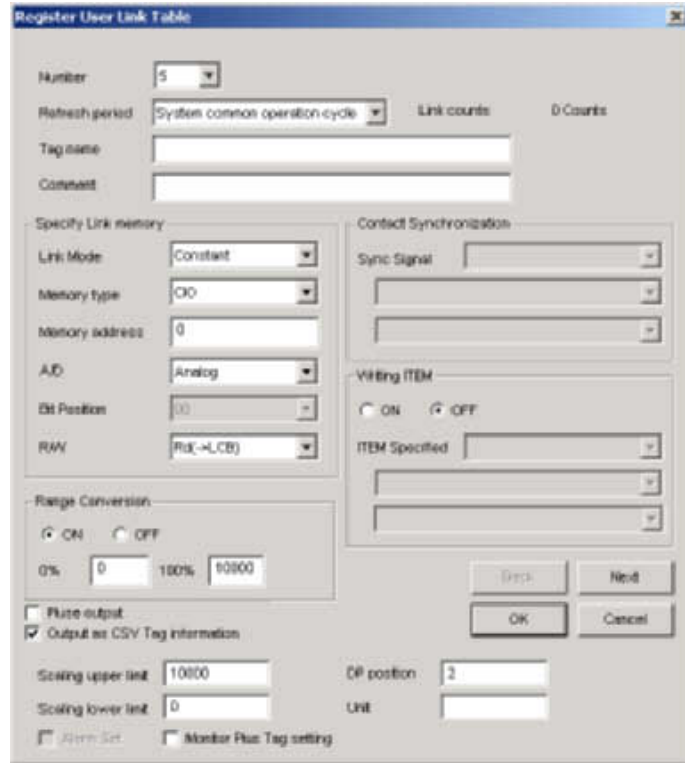

The dialog box titled "Register User Link Table" contains the following fields and controls:

- Number: 5
- Refresh period: System common operation cycle
- Link counts: [empty]
- D Counts: [empty]
- Tag name: [empty]
- Context: [empty]
- Specify Link memory:
 - Link Mode: Constant
 - Memory type: IO
 - Memory address: 0
 - A/D: Analog
 - Bit Position: 00
 - RAW: Raw-LCB
- Range Conversion:
 - ON (selected) / OFF
 - 0%: 0 / 100%: 10000
- Contact Synchronization:
 - Sync Signal: [empty]
 - [empty]
 - [empty]
- Writing ITEM:
 - ON / OFF (selected)
 - ITEM Specified: [empty]
 - [empty]
 - [empty]
- Buttons: Prev, Next, OK, Cancel
- Output options:
 - Plus output
 - Output as CSV Tag information
- Scaling upper limit: 10000
- Scaling lower limit: 0
- OP position: 2
- Unit: [empty]
- Alarm Set
- Monitor Plus Tag setting

User Link Table Settings

| Item | | Setting |
|-------------------------------|--------------------|--|
| Number | | Entry number For details on the entry number, refer to <i>3-5-4 Editing User Link Tables</i> . |
| Refresh period | | The refresh cycle for CPU Unit data. The cycle can be set to the system common operating cycle, 0.01 s, 0.02 s, 0.05 s, 0.10 s, 0.20 s, 0.50 s, 1.00 s, or 2.00 s (If the user link table is pasted in a block diagram to make software connections and the function block data is downloaded to the Loop Control Board with the Update User Link Table Refresh Cycle selection selected in the CX-Process Tool, the setting made here will be ignored and data refreshing with the CPU Unit will be performed on the operating cycle of the function blocks that are the destination of the software connections.) |
| Tag Name | | 16 characters max., any text string |
| Comment | | 23 characters max., any text string |
| Specify Link memory | Link Mode | Constant, On change, External sync |
| | Memory Type | Area in I/O memory of CPU Unit: CIO, W, H, DM, or EM0 (See note 2.) |
| | Memory Address | The address of the word in I/O memory to be allocated |
| | A/D | Analog or contact |
| | Bit Position | 00 to 15 |
| | R/W | RD (To Loop Controller) Wr (From Loop Controller) |
| Range Conversion | | ON/OFF 0% value and 100% value |
| Contact Synchronization | Synchronous Signal | ITEM specified (function block address and ITEM number) |
| Read from ITEM/Write to ITEM | | ON/OFF Specify a read ITEM and/or WRITE item (function block address and ITEM number) |
| Pulse Output (See note 1.) | | Select to specify a one-shot pulse output when the signal changes from OFF to ON. (Turns ON the output only once during the refresh cycle for user link tables and writes to the I/O memory of the CPU Unit.) Enabled only when A/D is a contact and R/W is Wr (from the Loop Control Board). |
| Output as CSV Tag Information | | Select this option to add user link table tags to the SCADA tag file or RS View tag file. Note If this option is not selected when registering the user link table, the user link table tags will not be output even if adding user link table information is selected during the output process. |
| Monitor Plus Tag setting | | Creates Monitor Plus tags. Select this option when monitoring or setting the user link table from the CX-Process Monitor Plus. |
| Alarm Set | | Creates alarm tags. If alarm tags are set, they can be displayed in the CX-Process Monitor Plus Alarm Log Screens. |

- Note**
1. EM1 to EM12 can be used in LCB□□ Ver. 3.0 or later projects
 2. Pulse outputs can be used in LCB□□ Ver. 3.0 or later projects.

3. The EM bank can be set independent of the type of CPU Unit. A Loop Controller execution error will occur, however, if an EM bank that is not present in the CPU Unit is specified in the user link tables. Refer to 4-5 *Monitor Run Status* for the procedure for confirming execution errors. The following Monitor Run Status Window shows an error status in ITEM 095.

| ITEM | Data Name | Data | Run |
|------|---------------------------------|------|-----------------|
| 096 | Reception disable switch | 0 | |
| 097 | Send disable switch | 0 | |
| 098 | Mn. block addr. Low MV limit | 000 | |
| 099 | Mn. block addr. High MV limit | 000 | |
| 100 | Mn. block addr. Deviation alarm | 000 | |
| 101 | Mn. block addr. Low flow alarm | 000 | |
| 102 | Mn. block addr. Low alarm | 000 | |
| 103 | Mn. block addr. High alarm | 000 | |
| 104 | Mn. block addr. High/High alarm | 000 | |
| 105 | Mn. block addr. PV error | 000 | |
| 106 | Mn. block addr. MV error | 000 | |
| 107 | Mn. block addr. Execution error | 000 | Detailed Dis... |
| 108 | Mn. block addr. Database error | 000 | Detailed Dis... |
| 095 | Mn. link Table error ID | 0 | |
| 120 | Backup start cmdl while running | 0 | |

3. Method 3: Batch Registration on the User Link Table Edit Screen

With CX-Process Tool version 3.2 or higher, multiple tags with the same attributes can be registered at the same time with the tag name to which serial numbers are attached. Consecutive I/O memory addresses in the CPU Unit will be automatically allocated to the tags. Up to 2,400 tags can be registered as a batch. The default is for 16 tags. The numbers added to the tag name will begin at 0001 for the number of tags required.

The following example shows registering 16 tags as a batch with the tag name “temperature setting” starting from DM 00100.

- 1) Select **Setting – Edit – User Link Table**.
- 2) Right-click on the User Link Table Edit Screen and select **Block Set** from the pop-up menu.
- 3) The following User Link Table Batch Registration Dialog Box will be displayed. Set the number of tags to register to 16, the tag name to “temperature setting,” the memory type to “DM,” and the memory address to 100.

Also select the option to output CSV tag information if it is to be output to the tag file.



- 4) Click the **OK** Button.
- 5) As shown below, tags from “temperature 0001” to “temperature 0016” are registered with the same attributes and addresses from DM 00100 to DM 00115 are allocated to them.

| Nu. | Tag name | Comment | Link c. | Refresh per. | Memor |
|------|------------------|---------|---------|--------------|-------|
| 0001 | temperature 0001 | | 0 | System co.. | CID |
| 0002 | temperature 0002 | | 0 | System co.. | CID |
| 0003 | temperature 0003 | | 0 | System co.. | CID |
| 0004 | temperature 0004 | | 0 | System co.. | CID |
| 0005 | temperature 0005 | | 0 | System co.. | CID |
| 0006 | temperature 0006 | | 0 | System co.. | CID |
| 0007 | temperature 0007 | | 0 | System co.. | CID |
| 0008 | temperature 0008 | | 0 | System co.. | CID |
| 0009 | temperature 0009 | | 0 | System co.. | CID |
| 0010 | temperature 0010 | | 0 | System co.. | CID |
| 0011 | temperature 0011 | | 0 | System co.. | CID |
| 0012 | temperature 0012 | | 0 | System co.. | CID |
| 0013 | temperature 0013 | | 0 | System co.. | CID |
| 0014 | temperature 0014 | | 0 | System co.. | CID |
| 0015 | temperature 0015 | | 0 | System co.. | CID |
| 0016 | temperature 0016 | | 0 | System co.. | CID |

Serial numbers 0001 to 0016 are automatically added to the file name.

DM 00100 to DM 00115 are automatically allocated to temperature 0001 to temperature 0016.

Note Once registered, the tag names and attributes can be changed individually, using the same method as in Method 1.

4. Method 4: Automatic Registration when Pasting Field Terminal Block and Creating Software Connections
 - 1) Select **Settings – Option**.
 - 2) On the User Link Table Tab Page of the Configure Project Information Setting Window, select the **Register Tag Name automatically when connected to Field Terminal** option.
 - 3) Paste the function block on the block diagram.
 - 4) When software connections are made, the ITEMS that are connected to the field terminal block will be automatically registered in the user link table.

3-5-3 Importing CX-Programmer Symbols into a User Link Table

If CX-Programmer is running on the same computer, information on all of the symbols in the local symbol table in the current CXP Project can be imported into a user link table.

Note The CX-Programmer must be version 2.0 or higher.

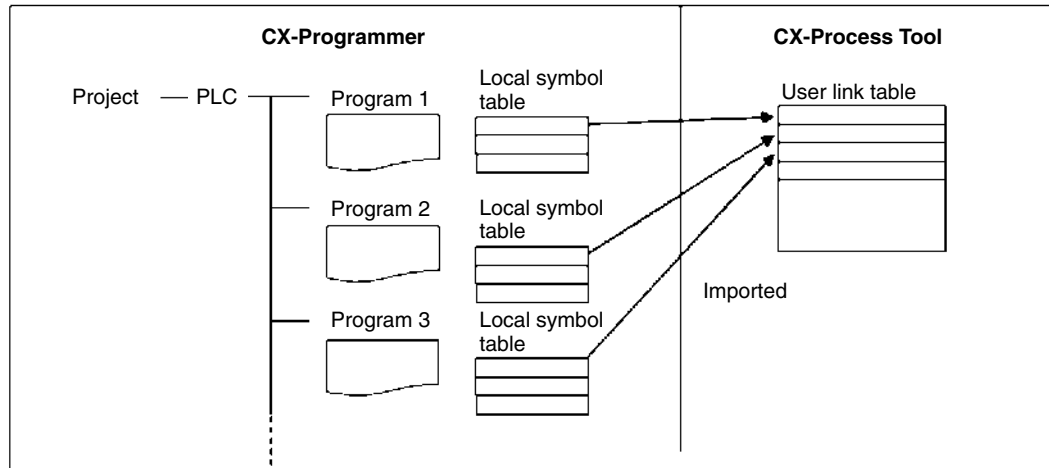

Use the following procedure.

- 1, 2, 3... 1. Start the CX-Programmer.
2. Select **Import CX-Programmer Symbols** from the Settings Menu. The following dialog box will be displayed.



3. Click the **OK** Button. The local symbol table from the CX-Programmer will be imported to the user link table in the CX-Process Tool as shown below.

- Example: CX-Programmer Symbol Table

| Name | Type | Address / Value | Rs. | Usage | Comment |
|-----------|------|-----------------|-----|-------|--------------------|
| AL1 | BOOL | 1.02 | | Work | Alarm Lamp1 |
| AL2 | BOOL | 1.03 | | Work | Alarm Lamp2 |
| AMSW | BOOL | 0.01 | | Work | Auto/Manual SW |
| AUTO | BOOL | W0.04 | | Work | Auto Operating |
| LIMIT1 | BOOL | 0.04 | | Work | Limit SW1 input |
| LIMIT2 | BOOL | 0.05 | | Work | Limit SW2 input |
| MAN | BOOL | W0.03 | | Work | Manual Operating |
| PRESS_ERR | BOOL | 0.03 | | Work | Press input error |
| ROT_ERR | BOOL | W0.02 | | Work | Rotate count error |
| START | BOOL | 0.03 | | Work | System run signal |

- Imported User Link Table

| Nu. | Tag name | Comment | Link counts | Refresh | Memory ty. | Memory address | Link Mode | R/W |
|------|-----------|--------------------|-------------|----------|------------|----------------|-----------|-----|
| 0001 | AL1 | Alarm Lamp1 | 0 | 2.00 sec | OIO | 00001 | Constant | Rd |
| 0002 | AL2 | Alarm Lamp2 | 0 | 2.00 sec | OIO | 00001 | Constant | Rd |
| 0003 | AMSW | Auto/Manual SW | 0 | 2.00 sec | OIO | 00000 | Constant | Rd |
| 0004 | AUTO | Auto Operating | 0 | 2.00 sec | W | 00000 | Constant | Rd |
| 0005 | LIMIT1 | Limit Sw1 input | 0 | 2.00 sec | OIO | 00000 | Constant | Rd |
| 0006 | LIMIT2 | Limit Sw2 input | 0 | 2.00 sec | OIO | 00000 | Constant | Rd |
| 0007 | MAN | Manual Operating | 0 | 2.00 sec | W | 00000 | Constant | Rd |
| 0008 | PRESS_ERR | Press input error | 0 | 2.00 sec | OIO | 00000 | Constant | Rd |
| 0009 | ROT_ERR | Rotate count error | 0 | 2.00 sec | W | 00000 | Constant | Rd |
| 0010 | START | System run signal | 0 | 2.00 sec | OIO | 00000 | Constant | Rd |

Data Imported from CX-Programmer Symbol Table

| CX-Programmer local symbol table | | | CX-Process Tool user link table | |
|----------------------------------|---------|---|---|--|
| Symbol name | | → | Tag name | |
| Type | BOOL | → | Contact | |
| | CHANNEL | → | Analog | |
| Address | | → | Memory type and memory address (bit position) | |
| R/W | | → | Always Rd | |
| Refresh cycle | | → | Always 2 s | |

Note The settings for the user link table will be saved automatically in an CSV format file called LnkTable.csv in a folder with the same name as the project when the project is saved. This file can be edited. The results of editing the file will be reflected in the user link table when the project is opened or when the active node is switched.

Contents of LnkTable.csv

| Item | Contents |
|---------------------------------|---|
| Node number | 0 to 32 |
| LNK number (See note a.) | Link number |
| Tag name | Tag name from user link table (only through 16th character) |
| Comment | Comment from user link table (only through 24th character) |
| Number of links | Automatically set by system (number of tags referenced) |
| Cycle | Refresh cycle (0 to 8) (0: System common operating cycle, 1: 0.01 s, 2: 0.02 s, 3: 0.05 s, 4: 0.10 s, 5: 0.20 s, 6: 0.50 s, 7: 1.00 s, or 8:2.00 s) |
| Memory type | 1: CIO, 2: W, 3: H, 4: DM, or 5: EMO |
| Memory address | Word address, 0 or higher |
| Mode | Link mode 1: Constant, 2: On change, or 3: External sync |
| R/W (See note a.) | 0: W (to Loop Controller, 1: R (From Loop Controller) |
| A/D (See note a.) | 0: D, 1: A |
| Bit position | 00 to 15 |
| 0% | 0% value of conversion range |
| 100% | 100% value of conversion range |
| ITEM R/W | 0: OFF BBBIII (BBB = block address, III = ITEM number): Read from ITEM |
| External contact sync | 0: OFF BBBIII (BBB = block address, III = ITEM number): External contact sync |
| Field terminal (See note a.) | 0: Not generated from field terminal BBBIII (BBB = block address, III = ITEM number): Link table generated from field terminal |
| MV tight shut | MV tight shut settings |
| Upper limit | MV tight shut upper limit |
| Lower limit | MV tight shut lower limit |
| MV reversing | MV reversing function settings |
| Pulse output | Pulse output settings |

Note a) These items cannot be changed.

b) Do not open a project while the TnkTable.csv file is open in Excel or other software. It may not be possible to read the data, and the user link table may not be initialized.

3-5-4 Editing User Link Tables

Entry Number Assignments in User Link Tables

A number is assigned to each entry in the user link table (referred to hereafter as entry numbers). In CX-Process Tool version 4.0 or higher, the method used to assign entry numbers when registering or deleting entries (version 3.2) is different from that used in the lower version (version 3.2). The method used to assign entry numbers when registering or deleting links depends on the CX-Process Tool version. The different methods are outlined below.

CX-Process Tool Version 4.0 or Higher

Any number can be selected as an entry number.

Entries can be registered to any entry number is possible, and the entry number is not changed when the entry is deleted.

Note When using LCB projects with unit Ver. 1.5 or earlier (LCB01 unit Ver. 1.5 or earlier, LCB05 unit Ver. 1.5 or earlier, CS1D-CPU6□P unit Ver. 1.0), however, entry

numbers cannot be downloaded in a batch if the entry numbers are not arranged beforehand. Always arrange the entries (right-click and select **Arrange Number**) before downloading.

CX-Process Tool Version 3.2 or Lower

Entry numbers are always in ascending order. When an entry is deleted, the entry numbers are automatically reassigned in ascending order.

Transferring User Link Tables

The restrictions in the following table apply to user link table selection and transfer using the CX-Process Tool in combination with a Loop Controller (LCB□□). Additions and deletions are not possible while the Loop Controller is in operation when using a combination of the CX-Process Tool Ver. 4.0 or higher and LCB□□ Ver. 2.0 or later. Other combinations require the transfer of LCB/LCB elements when entries are added or deleted. (The Loop Controller will stop operating when the LCB/LCB elements are transferred)

Selection and Transfer Capabilities according to the Version of the CX-Process Tool and Loop Controller

| CX-Process Tool Version | LCB Ver. 2.0 or later | LCB Ver. 1.5 or earlier |
|-------------------------|---|---|
| Ver. 4.0 or higher | <ul style="list-style-type: none"> Selected entries can be transferred and deleted while the Loop Controller is in operation. | <ul style="list-style-type: none"> Selected entries cannot be transferred or deleted during operation. LCB/LCB elements must be transferred when entries are added or deleted. An Arrange Number operation is required for entries when LCB/LCB elements are transferred to the Loop Controller. |
| Ver. 3.2 or lower | <ul style="list-style-type: none"> Selected entries cannot be transferred or deleted during operation. LCB/LCB elements must be transferred when entries are added and deleted. | <ul style="list-style-type: none"> Selected entries cannot be transferred or deleted during operation. LCB/LCB elements must be transferred when entries are added and deleted. |

Expansion Functions for CX-Process Tool Ver. 5.0 or Higher

Expansion function must be set when using user link table expansion functions supported by LCB□□ Ver. 3.0 or later. Select the entry in the user link table for which the expansion functions are to be set. Editing can be performed by right-clicking and selecting **Edit – Extension** from the pop-up window. For information on each function, refer to the *Loop Control Boards Operation Manual* (Cat. No. W406).

The following functions can be set as expansion functions for LCB□□ Ver. 3.0.

MV Tight Shut

MV tight shut settings are made in user link tables for output attributes.

- 1, 2, 3...**
1. Right-click the entry for the output attribute (i.e., Wr) and select **Edit – Extension** from the pop-up window.

2. The Extension Dialog Box will be displayed.



3. Select the *MV tight shut* Check Box and enter the upper and lower limits. (See note.)

Note The tight shut upper limit is always 320.00% and the lower limit is -320.00%.

MV Reversing

MV reversing settings are made in user link tables for output attributes.

- 1, 2, 3... 1. Select the entry for the output attribute. Right-click and select **Edit – Extension** from the pop-up window.
- 2. The Extension Setting Dialog Box will be displayed.



3. Select the **MV Reversing** Check Box.

The MV tight shut and MV reversing functions can be set from the following field terminals. The extension settings will be made automatically for the entries for user link table entries generated by the connection lines to each field terminal.

| Applicable field terminal | Tight shut upper limit | Tight shut lower limit |
|--------------------------------------|------------------------|------------------------|
| Isolated AO 4-point terminal (PMV01) | 115.00% | -20.00% |
| Isolated AO 4-point terminal (PMV02) | 115.00% | -15.00% |

Procedure for Settings from Field Terminals

- 1, 2, 3... 1. Register the field terminal.
- 2. Connect lines to function blocks.

- Open the ITEM List Window for the field terminal, right-click the ITEM List Window, and select **Extension**. (An error will occur if no lines are connected to the function block.)

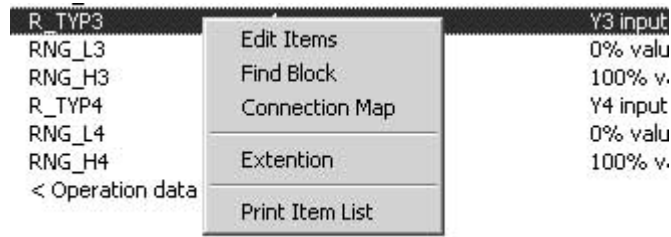

- The Extension Setting Dialog Box will be displayed.



- Make the setting by specifying the channel number to be set.
- To make the same settings for all channels, click the **Set to all channel** Button. For example, if channels 1, 2, and 4 already have connection lines completed, the same settings will be reflected in channels 1, 2, and 4 if the button is clicked. The settings will not be reflected in channel 3, for which connection lines have not been completed.

Only the entry for the relevant user link table can be displayed in the User Link Table Window using the following procedure if extension settings are made from the field terminals.

- 1, 2, 3...**
 - Select the field terminal to be displayed from the Workspace tree.
 - Right-click and select **Find – User Link Table**.
 - The relevant user link table for the selected field terminal will be displayed. When the User Link Table Window is displayed, right-click and select **Specified as Field Terminal**.

User Link Table Edit Menu

Right-click at the top of the User Link Table to display the editing menu described in the following table.

| Pop-up menu | | Functions |
|---------------------------------|-------------------------|---|
| Add | | Registers an entry for a single link (tag) in the User Link Table. |
| Block Set | | Registers multiple links (tags) with the same attributes in the User link Table at the same time with tag name to which serial numbers are attached. |
| Move | | Increases the entry numbers for the specified entry and all entries lower than it by an increment of 1. |
| Arrange Number (See note 1.) | | Reassigns all entry numbers in ascending order. (This is not a reordering function.) The reference for the related function blocks is also automatically changed by this operation. |
| Edit (See note 2.) | Selected | Edits the selected entry. |
| | Extension | Makes the extension settings for a selected entry (see note 2). |
| Delete | Selected Entries | Deletes selected entries. After deletion, the corresponding entry numbers are available. |
| | No Connection | Deletes all the entries for zero links at the same time. After deletion, the corresponding entry numbers are available. |
| | Delete Registered Entry | Deletes the CX-Process Tool entry and the entry stored in the LCB at the same time. |
| Update Refresh Cycle | Selected Entries | Sets the refresh cycle for the selected entries to match the operation cycle of the destination function block. |
| | All Entries | Sets the refresh cycle for all entries to match the operation cycle of the destination function block. |
| Find | | Finds entries by tag name. |
| Download (See note 3.) | Selected Entries | Downloads the selected entries only. |
| | All Entries | Downloads all entries. |
| Filter | | <p>Entries are displayed according to the following filter settings.</p> <ul style="list-style-type: none"> • Analog Contact: Displays the analog signal data or contact signal data. • Read/Write: Displays entries that read from or write to the CPU Unit memory. • Memory Area: Filters according to memory area (CIO,W,H,DM,EM) • Field Terminal: Displays the entries with field terminal attributes. • Specified as Field Terminal: Selected when a user link table is displayed for which extension settings have been made. • No Connection: Displays entries with zero links. |
| Connection Map | | Displays the connection map for the selected entry. |
| Print | | Prints the user link table. |
| Cut | | Cuts an entry and places it in the special copy buffer for the CX-Process Tool (i.e., not on the clipboard). |
| Copy | | Copies an entry and places it in the special copy buffer for the CX-Process Tool (i.e., not on the clipboard). |
| Paste | | Pastes the entry from the special copy buffer for the CX-Process Tool (i.e., not from the clipboard). |

Note 1. When using LCB projects with unit Ver. 1.5 or earlier, entry numbers cannot be downloaded in a batch if the entry numbers are not arranged beforehand. Always arrange the entries before downloading

2. Extension can be used with LCB projects of Ver. 3.0 or later.
3. When using LCB projects with unit Ver. 1.5 or earlier, if specified entries or all entries are downloaded, always download the LCU or LCB elements.

3-6 Creating User-defined Blocks

3-6-1 Overview

Groups of function blocks with analog I/O connections can be registered as a signal user-defined block. The user-defined blocks can be saved and reused as required (CX-Process Tool version 3.2 or higher).

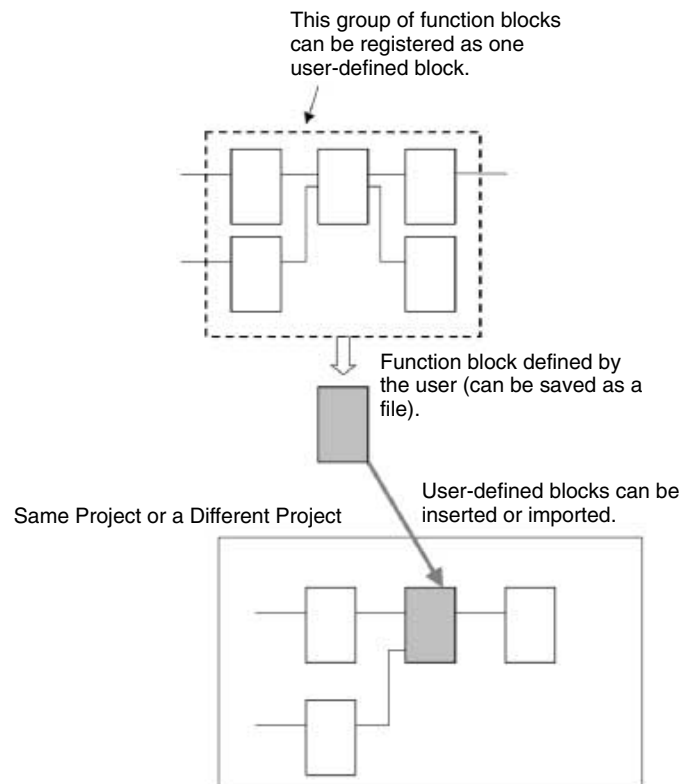

For example, a commonly used control method consisting of a group of function blocks for cascade control, feedforward control, etc., and including any analog I/O compensation and switching blocks required before and after the main blocks, can be registered as one group. With a user-defined block like this one, you can eliminate the need to register and connect function blocks for each control method or process. Just read in a user-defined block created in advance and combine it with the analog I/O terminals required by the system to easily create function block data.

User-defined blocks can be saved in files with a file name extension of .ucb. These files can be read into other projects to enable reusing the user-defined block.

3-6-2 How User-defined Blocks Work

Configuration

User-defined blocks consist of the following:

- 1, 2, 3... 1. A group of function blocks (the algorithm indicated in dotted lines in the diagram)
2. A virtual block that functions as the input interface block to handle input data for the above group of blocks

3. A virtual block that functions as the output interface block to handle output data for the above group of blocks

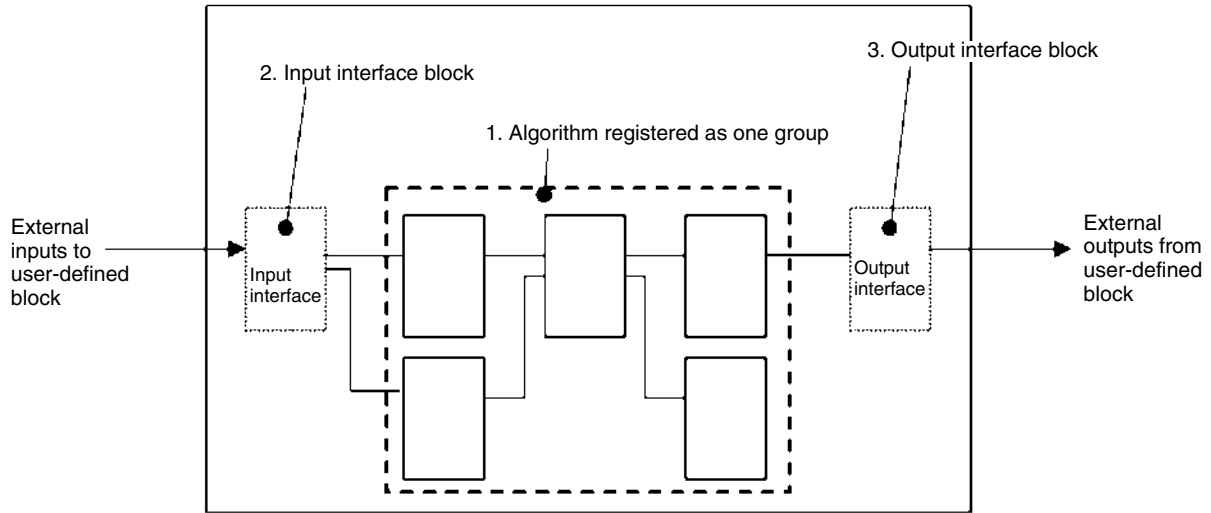

Note The only external I/O for a user-defined block are the analog I/O connected to the input and output interfaces. Reading and writing ITEMS in the function blocks within the user-defined block is performed in the same way as for any other function block.

Function Blocks Not Supported in User-defined Blocks

The following function blocks cannot be used in user-defined blocks:

- Field Terminals
- User link tables
- Sequence tables
- Step ladders

Create these function blocks outside of the user-defined blocks.

The CX-Process Tool version 4.0 or higher is required to register step ladder blocks in user-defined blocks.

All other function blocks can be used in user-defined blocks.

Up to 96 user-defined function blocks can be created in each function block file.

Restrictions in the Number of User-defined Blocks

Displaying User-defined Function Blocks

User-defined function blocks are displayed as one function block with the input and output names assigned in the input and output interfaces.

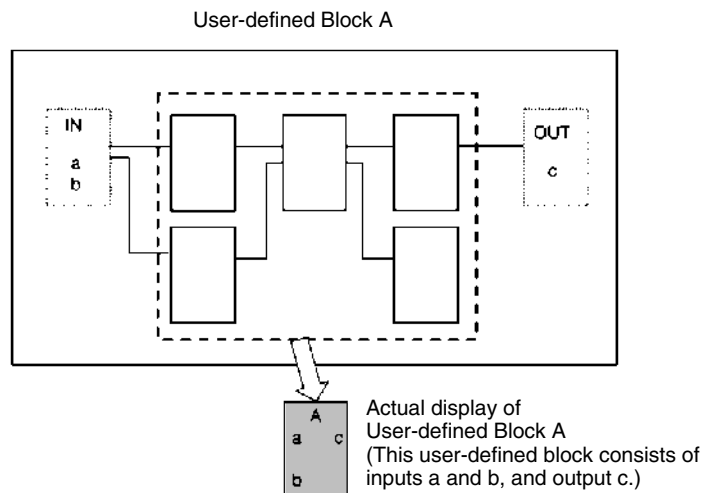

User-defined Blocks Pasted with Other Function Blocks

User-defined blocks can be inserted into a function block diagram for use with other function blocks.

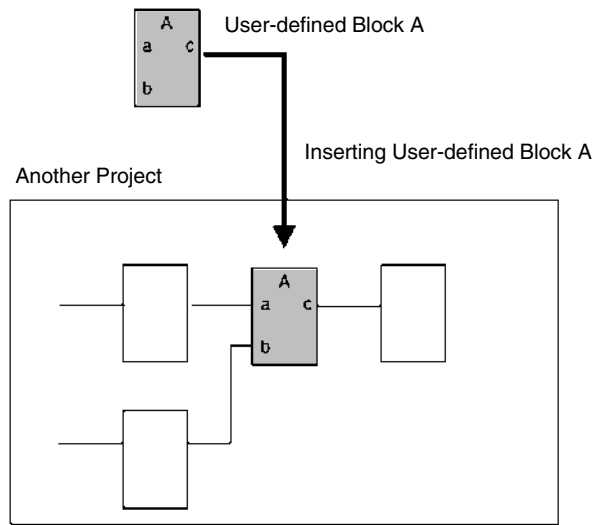

3-6-3 Creating User-defined Blocks on the CX-Process Tool

The following example shows how to create a user-defined block. In this example, a user-defined block is created for feedforward control (shown in dotted lines in the following diagram).

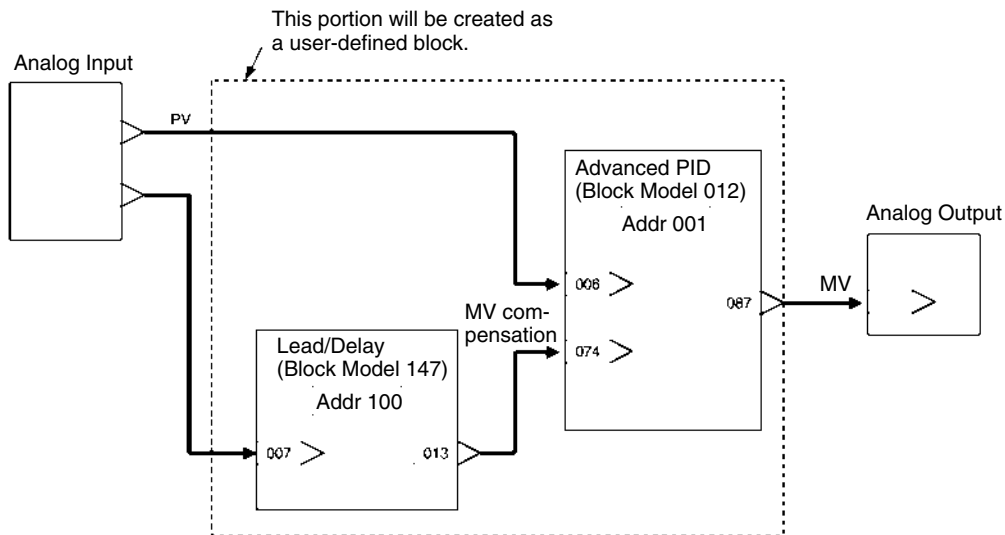

- 1, 2, 3... 1. Create a new block diagram by selecting the LCU or LCB element, right-clicking, and selecting **Insert**. Alternately, select an existing block diagram.
2. Input the name of the user-defined block as the name of the function diagram.

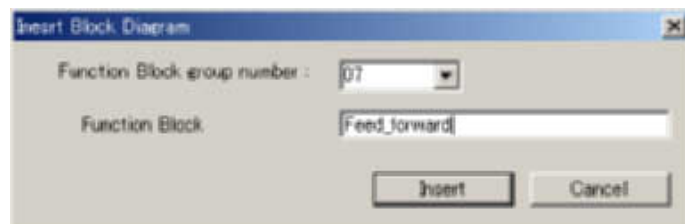

3. Select **Setting – User-defined Block – Create**. As shown below, the background of the block diagram will change to purple.

An input interface (I/F) block and output interface block will also be inserted automatically. These two blocks are virtual blocks that will serve to assign external I/O for the user-defined block.

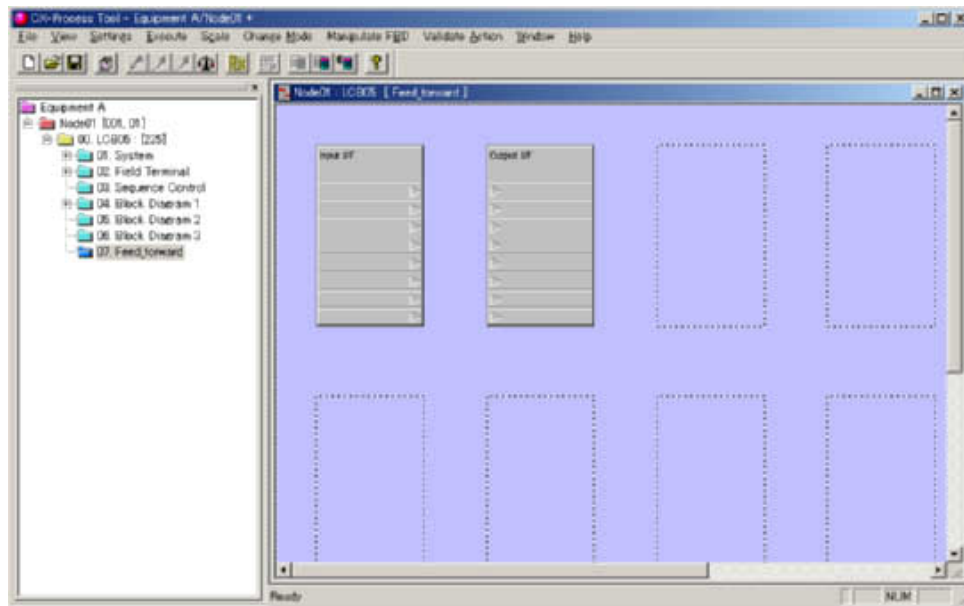

- Adjust the layout of the function blocks and insert an Advanced PID (Block Model 012) and a Lead/Delay (Block Model 147) block. (Right-click and select them from the **Register – Control Block** on the menu.)

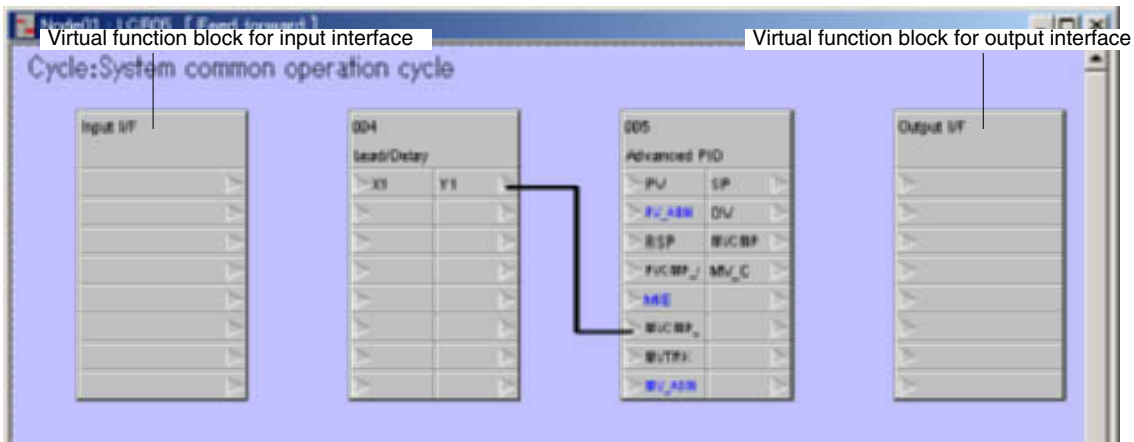

- Set the I/O interfaces.

Setting the Input Interface

Connect the analog inputs to be input to the user-defined function block to the input interface block. In this example, the PV input for the Advanced PID (Block Model 012) block is connected to the right of the input interface block.

When the connection is made, the following Input/Output Setting Dialog Box will be displayed.

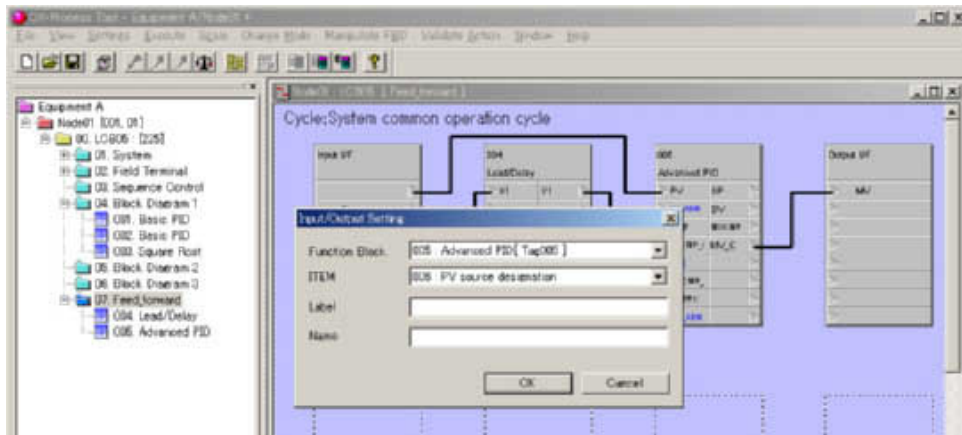

Input some text for the comment, e.g., “PV.”

In the same way, connect another spot on the right side of the input interface block to the input (X1) of the Lead/Delay (Block Model 147). Input some text for the comment, e.g., “DIST.”

Setting the Output Interface

Connect the analog outputs to be output from the user-defined function block to the output interface block. In this example, the MV input from the Advanced PID (Block Model 012) block is connected to the left of the output interface block. A comment, such as “MV” can be input.

6. The results is shown below.

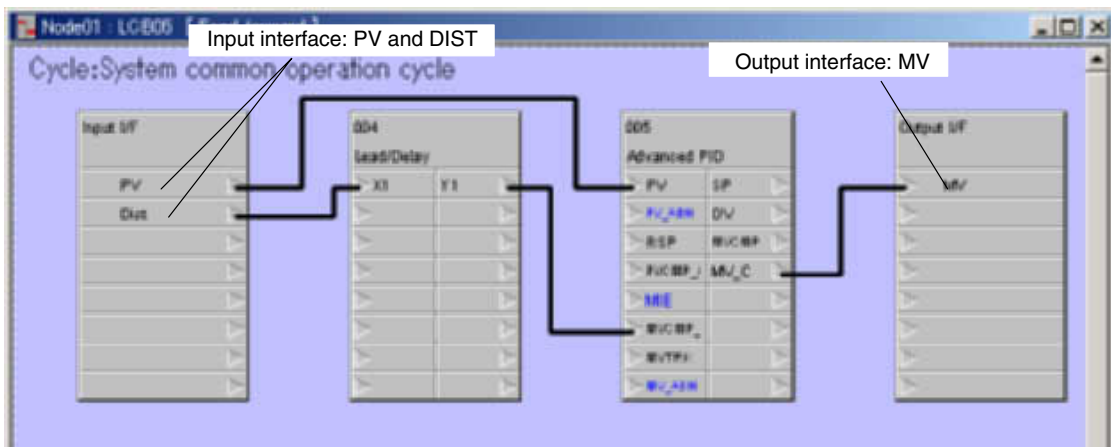

3-6-4 Inserting User-defined Blocks

- 1, 2, 3... 1. Place the cursor in the block diagram where the user-defined block is to be inserted, right-click, and select **Register – User-defined Block – Insert User-defined Block**. As shown below, the block will be inserted as a single

block showing the comments set for the input interface and the comment set for the output interface.

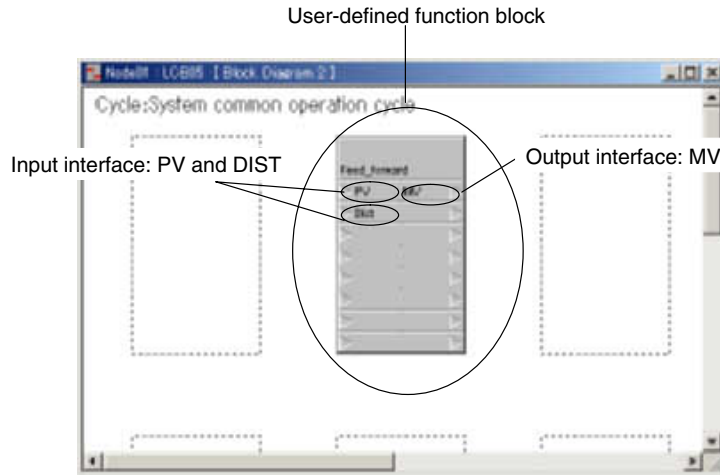

2. Register analog input and analog output terminals and connect the user-defined block between them, as shown below.

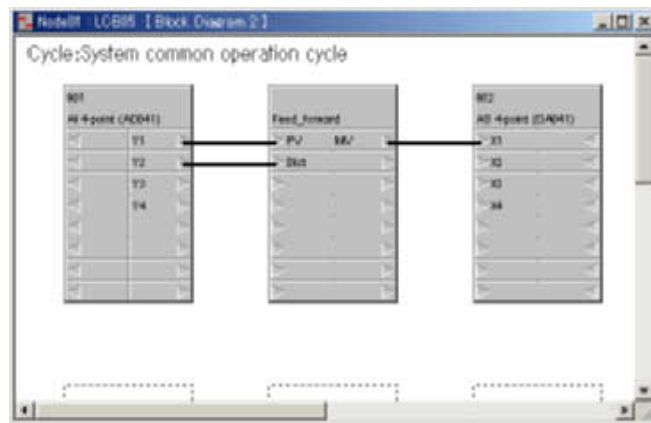

Note The user-defined names for a user-defined block can be changed by selecting the block on the Project Workspace tree, right-clicking, and selecting **Change Comment**.

3-6-5 Exporting User-defined Blocks to Files

Select the user-defined block to be exported to a file (.ucb) and select **Settings – User-defined Block – Export**. The following dialog box will be displayed. Input the file name and save the file.

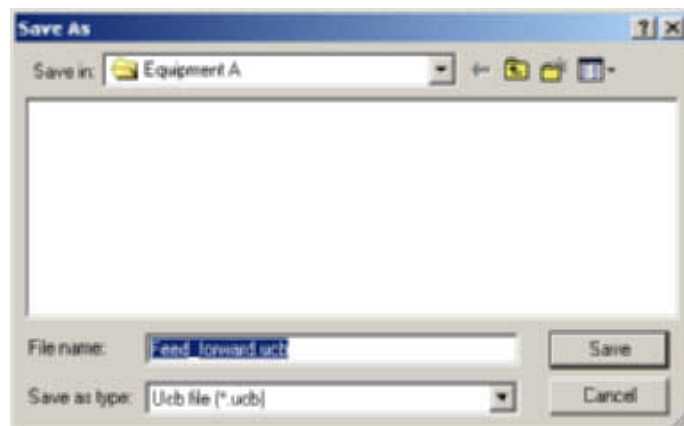

The file type is ucb (file name extension: .ucb).

3-6-6 Importing User-defined Blocks from Files

Open the project into which the user-defined block is to be imported, select the LCB element, and select **Settings – User-defined Block – Import**. Specify a file (.ucb), input a function block name for the user-defined block, and click the **Set** Button. The block will be imported as shown below.

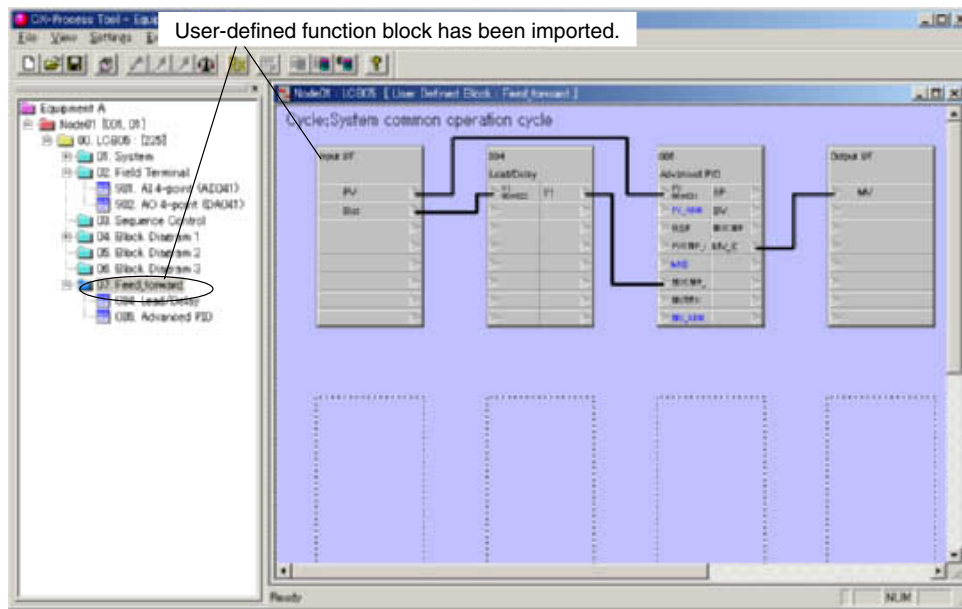

Note Only upward compatibility is ensured for exported user-defined block files.

Example:

- User-defined blocks created using LCB Ver. 3.0 cannot be imported to projects using LCB Ver. 2.0.
- User-defined blocks created using LCB Ver. 1.5 can be imported to projects using LCB Ver. 3.0.

3-7 Creating Step Ladder Program Instructions

This section provides information on the creating a step ladder program (block model 301). Either a ladder diagram or mnemonics can be selected to create the step ladder program.

If the CX-Process Tool's version is 2.50 (or higher) and ITEM200 (the Mnemonic Flag) is set to 0, the program will be assembled automatically (ladder diagram to mnemonic conversion) when it is downloaded and disassembled automatically (mnemonic to ladder diagram conversion) when it is uploaded.

If ITEM200 (the Mnemonic Flag) of a step ladder program (block model 301) is set to 1, the program will not be assembled and disassembled automatically and it cannot be assembled and disassembled manually. In this case, the created step ladder program cannot be downloaded to the Loop Controller, although mnemonic programs can be download and uploaded.

3-7-1 Ladder Diagrams

Take the following steps to create a step ladder program in a ladder diagram.

- Note**
1. When creating a ladder diagram, ITEM200 (the Mnemonic Flag) of the step ladder program (block model 301) must be set to 0.
 - If ITEM200 (the Mnemonic Flag) is set to 0, the CX-Process Tool (Version 2.50 or higher) will automatically assemble the program (convert ladder diagram to mnemonic) when it is downloaded and disassemble the program (convert mnemonic to ladder diagram) when it is uploaded. It will also be possible to manually assemble/disassemble the program.
 - If ITEM200 (the Mnemonic Flag) is set to 1, the program will not be assembled and disassembled automatically and it cannot be assembled and disassembled manually. In this case, the created step ladder program cannot be downloaded to the Loop Controller, although mnemonic programs can be download and uploaded.
 2. When ITEM200 (the Mnemonic Flag) is set to 0, always convert the mnemonic code before downloading the step ladder program block created in the ladder diagram to the Loop Controller. If the mnemonic code is not converted, the mnemonic code (STEP00 only when the default is used) that was created with the previous assemble operation will be downloaded.
 3. Confirm that equipment will not be adversely affected before changing timer command settings. Machines and devices may perform unexpected operation if settings are transferred incorrectly.
 4. Each program block in a ladder diagram can have up to 22 lines and 10 columns.

Always set ITEM200 (the Mnemonic Flag) of a step ladder program (block model 301) to 0 in advance. When the Mnemonic Flag is set to 0, the program will be converted to mnemonic code automatically (assembled) when it is downloaded to the Loop Controller. (This function is supported by Loop Control Unit Version 2.50 and later versions, or LCB□□s.)

- 1, 2, 3... 1. Click the 07. Sequence Control Folder and select **Insert/Insert Function Block** from the Settings Menu so that the Step Ladder Program Block will be allocated to a block address.
2. Select the Step Ladder Block, and select **Edit/Step Ladder Program** from the Settings Menu.

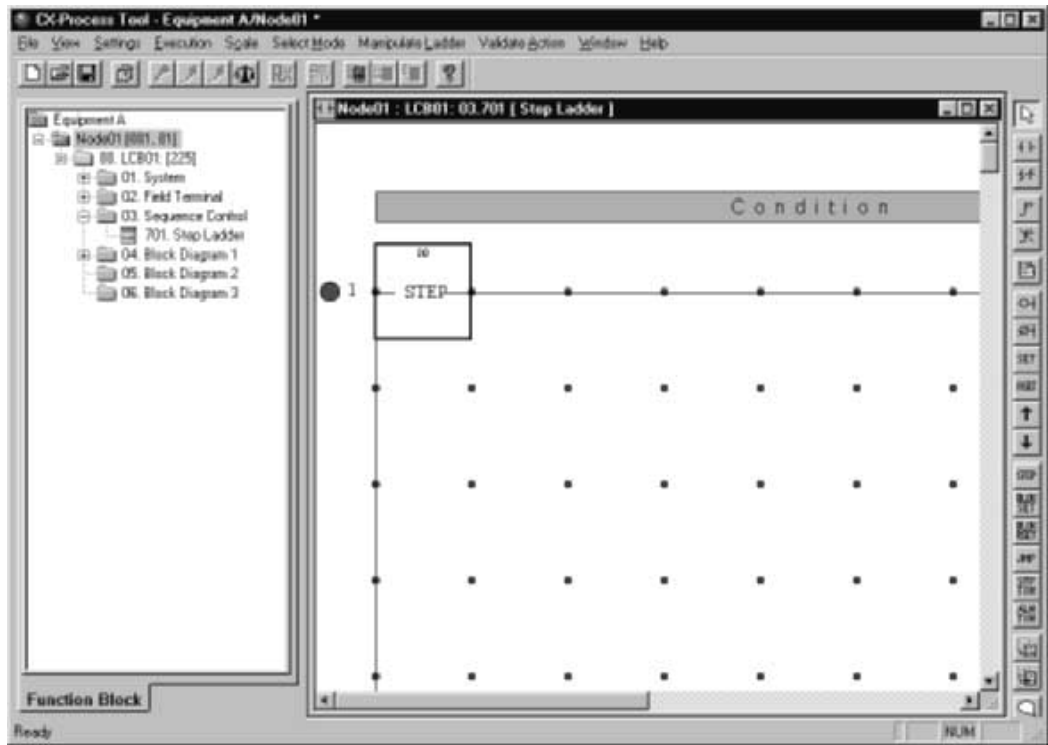

3. The following screen will appear.



4. Click an icon on the right toolbar. The ladder diagram of the instruction will appear under the cursor. Move the cursor to the desired position on the ladder diagram and click the position.

To input an input instruction, such as LOAD, for example, click an instruction position other than one on the right edge (i.e., a condition position).

To cancel the symbol allocated to the cursor, click the  icon or move the cursor to the position to be overwritten and select the instruction from the Select Mode Menu.

Example: For the LOAD instruction, click the  icon, and the icon of the cursor will change to . Move the cursor to the position to be overwritten and click the position. The LOAD instruction (with a NO contact) will appear.

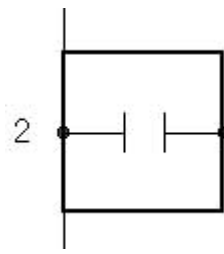

Press the Delete Key to delete the instruction.

- To input the operand, click the  icon to return the cursor to normal. Double-click the ladder diagram symbol. The following dialog box will appear.



Input the block address and ITEM number.

Here, select ITEM 026 at block address 001 and click the **OK** Button.

Note In the ladder diagram, “-” will appear between the block address and ITEM number.

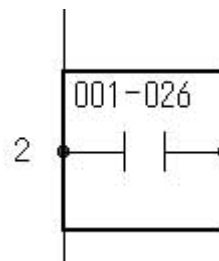

- To input an output instruction, such as OUT, for example, click the instruction on the right edge (i.e., the Manipulate Ladder position), and input the instruction in a method similar to the one used for input instructions.

Note You cannot use Internal Switch as an operand for an output instruction, such as OUT.

- Connect the right edge of the input instruction written at the condition position to the output instruction written at the operation position.

To draw a vertical or horizontal line, click the  icon and move the cursor to the start point. Click the start point with the left mouse button, drag the mouse, and release the button at the end point.

To delete lines drawn in the above steps, click the  icon and move the cursor to the start point. Click at the start point, drag the mouse, and release the button at the end point.

Ladder Example

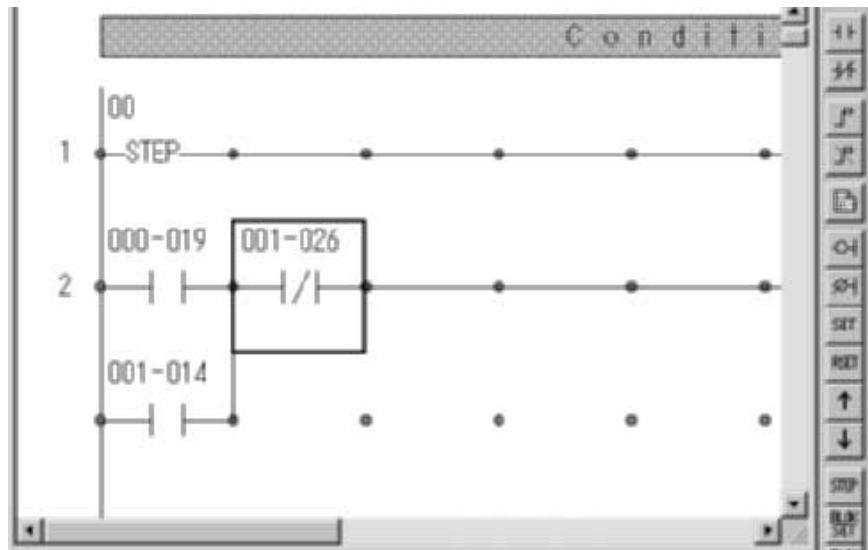

- Note**
1. The ladder diagram display can be zoomed into by pressing the **Alt + Left Cursor** Keys. The ladder diagram display can be zoomed away from pressing the **Alt + Right Cursor** Keys.
 2. Symbols, areas, or rows that have been input can be copied, cut, and pasted to edit ladder diagrams. Use a procedure like the following example for copying and pasting an area.
 - a) Select the area to be copied.

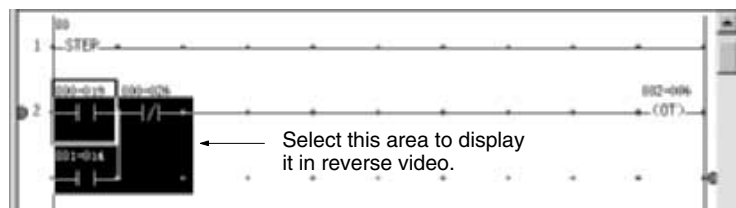

- b) Click the right mouse button and select **Copy** from the pop-up menu.

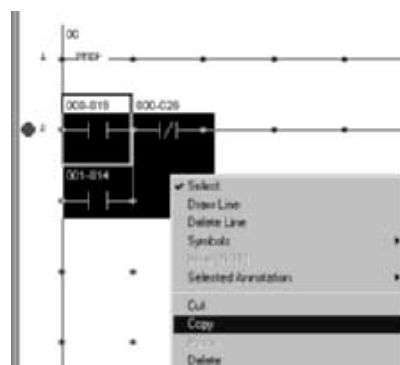

- c) Select the upper left corner of the area where the data is to be pasted. A black frame will be displayed.

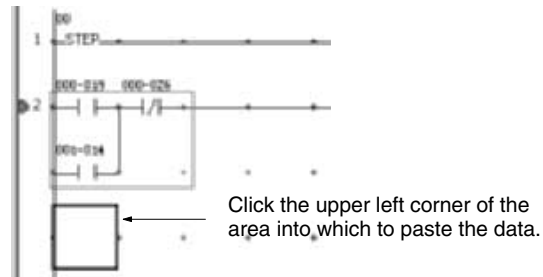

- d) Click the right mouse button and select **Paste** from the pop-up menu.

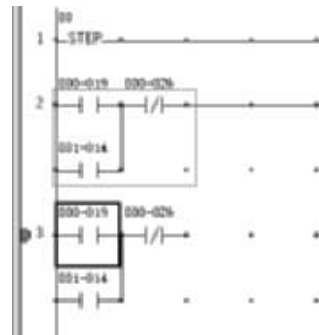

Inserting Comments (Annotations)

With Loop Control Unit versions 2.50 or later and LCB□□s, it is possible to insert annotations (user-defined text) into ladder diagrams in Edit Step Ladder Program Mode. The annotations are a kind of symbol.

Up to 16 annotations can be inserted in one ladder diagram and up to 3,000 annotations can be inserted in one function block file. Each annotation can be up to 200 characters long.

This function allows user-set labels (such as “A/M Switch” or “RSP/LSP Switch”) to be inserted and displayed next to symbols such as LD or OUT. The diagrams Loop Controller with annotations can also be printed out to create complete schematics showing the program sequence. (For details on downloading annotation data, refer to 4-9 *Transferring Tag and Comment Data* on page 309.)

Use the following procedure to insert annotations.

- 1, 2, 3... 1. Click the Annotation icon and move to the location where the annotation will be inserted. As symbols, annotations can be inserted at symbol positions. The new annotation will contain the default text “Comment Data” as shown in the following diagram.

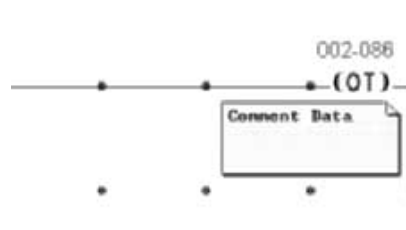

- 2. Click the Annotation icon.

Note If this icon is not clicked, a new annotation will be inserted each time that the mouse is clicked in the ladder diagram.

- To edit the text in the annotation, double-click the annotation. The following diagram shows the appearance of the annotation when it can be edited.

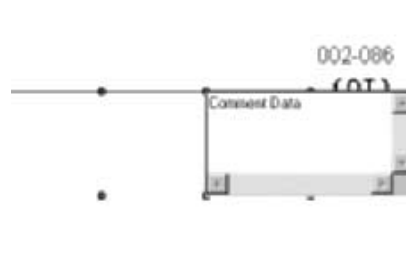

- Input the text. In this example, "A/M Switch" has been input. (Press the **Enter** Key to create a new line.)

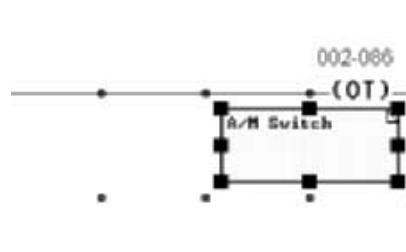

- To stop editing the annotation, click on something other than the annotation. The annotation will contain the new text.

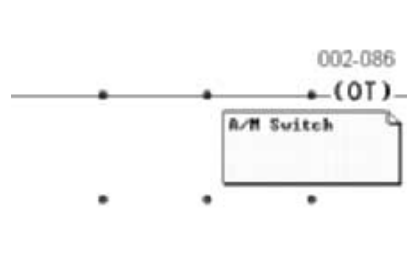

- Note**
- To change the size of the font in the annotation, select the annotation, click the right mouse button to display the pop-up menu and select **Selected Annotation/Font Size**. (The default font size is 12 points.)
 - If the text is not being displayed, even if the font size is changed, it may be necessary to enlarge the annotation. Select the annotation again, select the ■ symbol on the right side of the annotation (arrows will be displayed on both sides of the symbol), and enlarge the annotation.
 - When the annotation is displayed over a function block or connecting line and covers up a symbol, select **Selected Annotation/Send Behind Symbols and Lines**.
 - If two annotations overlap, either one can be moved to the front or back by selecting **Selected Annotation/Bring to Front** or **Selected Annotation/Send to Back**.

Converting Ladder Diagrams to Mnemonics

Take the following steps to convert the step ladder programs created in the ladder diagram into mnemonic code and display the program in mnemonic code. This procedure is possible only when ITEM200 (the Mnemonic Flag) of the step ladder program (block model 301) is set to 0. The step ladder program cannot be converted to mnemonic code if ITEM200 is set to 1.

- 1, 2, 3... 1. Select **Mnemonics** from the Manipulate Ladder Menu or click the  icon. The following screen will appear.



2. Click the **Refresh** Button. The step ladder program in the ladder diagram will be converted into mnemonics and displayed as shown below.

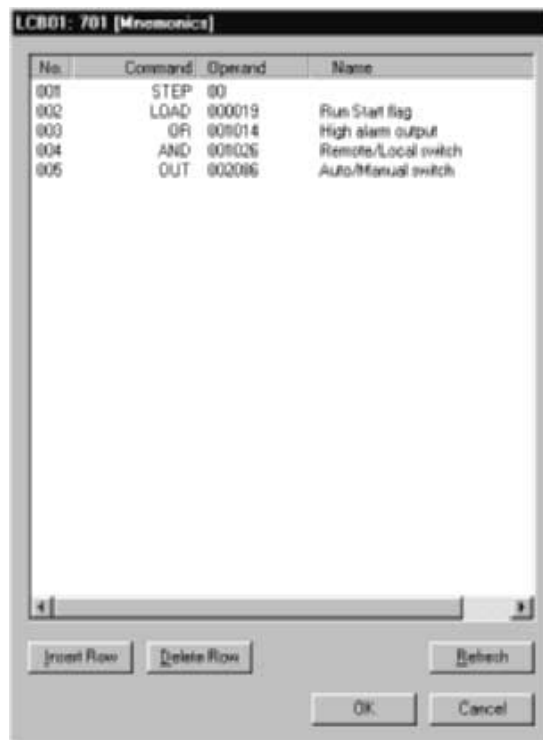

Note To convert the step ladder programs in the ladder diagram into mnemonics when the Mnemonics Dialog Box is not displayed, select **Convert Ladder to Mnemonics** from the Manipulate Ladder Menu.

The user may click the  icon instead, to execute the same the function as the **Refresh** Button in the above Mnemonics Dialog Box.

- Note**
1. Unless the step ladder programs are converted, the cross-reference function will not be available.
 2. If an Internal Switch occurs in a ladder diagram that has been created, the Internal Switch will appear as shown below. The OUT instruction and LOAD instruction in mnemonics will be automatically created and the operand will be the ITEM of the Internal Switch (in block address 349 by default).
Example: The OUT instruction and LOAD instruction will be automatically created with internal switch 349011 as the operand.

Before Conversion

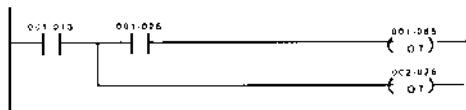

After Conversion

| No. | Command | Operand | Name |
|-----|---------|---------|------------------------|
| 001 | STEP | 00 | |
| 002 | LOAD | 001013 | High/High alarm output |
| 003 | OUT | 999011 | Internal Switch |
| 004 | AND | 001005 | Remote/Local switch |
| 005 | OUT | 001006 | Auto/Manual switch |
| 006 | LOAD | 999011 | Internal Switch |
| 007 | OUT | 002026 | Remote/Local switch |

Up to eight internal switches can be created. An error will result if the user attempts to convert a step ladder program with nine or more internal switches.

3-7-2 Mnemonics

Take the following steps to create the step ladder programs in mnemonics. If the program may be converted to a ladder diagram later, observe the same restrictions on the number of lines and columns for ladder diagrams when creating the program in mnemonic code. The following table shows the required settings for ITEM200 (the Mnemonic Flag) for various situations.

| Ladder program conversion | Max. program block size | ITEM200 (Mnemonic Flag) setting |
|---------------------------|----------------------------------|--|
| Required | 22 lines × 10 columns (or fewer) | Set to 0. |
| Not required | --- | Set to 1. |
| Not possible | More than 22 lines × 10 columns | Set to 1. (It will not be possible to convert to ladder diagram format.) |

- Note**
1. Each program block in a ladder diagram can have 22 lines and 10 columns, but there is no limit on the number of lines and rows when mnemonic code is used. If a program is created in mnemonic code and contains a program block with more than 22 lines or 10 columns, an error will occur if the program is converted to a ladder diagram (disassembled).

When creating a program that is incompatible with ladder diagram format, set the Mnemonic Flag (ITEM200) to 1 to disable automatic assembly and disassembly by the CX-Process Tool. (This function is supported by Loop Control Unit Version 2.50 and later versions, or LCB□□s.)

2. No syntax check will be made on the step ladder program instructions being created in mnemonics. The step ladder programs will be transferred to the Loop Controller as they are. A syntax check will be made on the step ladder programs when the Loop Controller starts operating and any execution errors will be stored in the Loop Controller. The error codes can be checked on the Monitor Run Status Screen.
- 1, 2, 3...**
1. Select the Step Ladder Block and select **Edit/Step Ladder Program** from the Settings Menu.
 2. Click the  icon or select **Mnemonics** from the Manipulate Ladder Menu. The following screen will appear.



3. Take the following steps to input the instructions and operands from the keyboard.
 - a) Click **Insert Row**.



- b) Double-click the Instruction Field.



- c) Input the instruction. Example: LOAD

Note a) The instruction may be in lowercase or uppercase characters.

- b) Input "LOAD" and not "LD," otherwise the instruction will not be accepted.

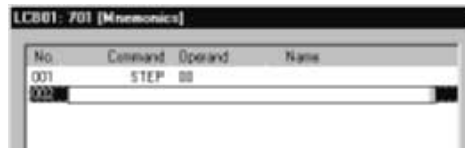

- d) Click the Operand Field. If it is a contact ITEM, input the operand (i.e., block address and ITEM number) in six digits. Example: 001013

Note In the ladder diagram, "-" will appear between the block address and ITEM number. In mnemonics, do not insert "-" between the block address and ITEM number when inputting data.

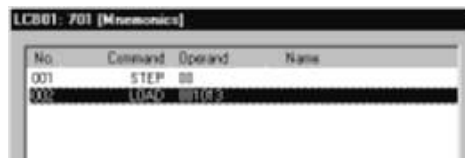

- e) Click a blank area or press the **Return** Key so that the highlighted portion will return to normal.

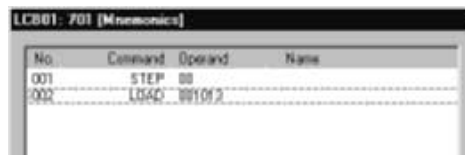

- f) Click **Insert Row**. The next row will be highlighted as shown below.

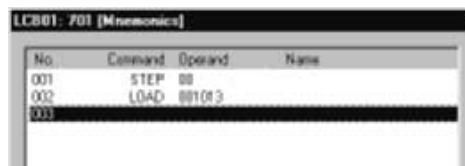

- g) Input the remaining instructions.
- h) Click the **OK** Button.

If nothing can be input, press the Esc Key.

Note To delete a row, highlight the row and click **Delete Row**.

Mnemonic Input Example



Converting Mnemonics to Ladder Diagram

Use the following procedure to convert a step ladder program created in mnemonics or uploaded into a ladder diagram. This procedure is possible only when ITEM200 (the Mnemonic Flag) of the step ladder program (block model 301) is set to 0. The step ladder program cannot be converted to mnemonic code if ITEM200 is set to 1.

Select **Convert Mnemonics to Ladder** from the Manipulate Ladder Menu or click the  icon. The mnemonics will be converted to a ladder diagram.

- Note**
1. When uploading a step ladder program (block model 301) from a unit Ver. 2.00 or earlier Loop Control Unit, ITEM200 (the Mnemonic Flag) will be set to 1 automatically. Change this setting to ITEM200=1 when the program is converted to ladder diagram format.
 2. No syntax check will be made on step ladder programs being created in mnemonics. Therefore, when a step ladder program is converted into a ladder program, the instruction blocks may be illegal.
 3. If ITEM200 (the Mnemonic Flag) is set to 0, the program will be disassembled automatically (mnemonic to ladder diagram conversion) during the upload operation when it is uploaded from the Loop Controller.

3-7-3 Cross-reference Display

Take the following steps to display the cross-references for a step ladder program. The cross-references show the instructions with their contact addresses and mnemonic row numbers in the Step Ladder Block for each block address.

Note Before displaying the cross-references, convert the ladder diagram into mnemonics, otherwise no cross-references will be displayed.





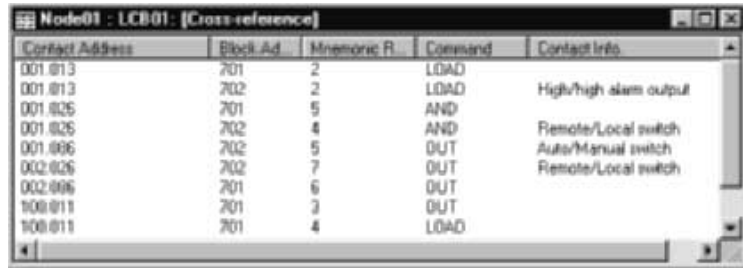



- 1, 2, 3...**
1. Select **Convert Ladder to Mnemonics** from the Manipulate Ladder Menu or click the **Refresh** Button while the mnemonics are displayed, and then click the **OK** Button.



2. Select the LCU/LCB element, and select **Cross-Reference** from the Execution Menu. The following screen will appear.



3-7-4 Step Ladder Instructions







| Command | Icon | Select Mode menu | Operand | Description | O: Can be used -: Cannot be used | |
|----------|------|------------------|---|---|-------------------------------------|------------------|
| | | | | | In logic sequence | In step sequence |
| LOAD | | LOAD | Read source block address/ITEM number | Indicates a logical start of the logic block, creates an ON/OFF execution condition based on the ON/OFF status of the contact, and connects to the next stage. | O | O |
| LOAD NOT | | LOAD NOT | Read source block address/ITEM number | Indicates a logical start of the logic block, creates an ON/OFF execution condition based on the reverse of the ON/OFF status of the contact, and connects to the next stage. | O | O |
| AND | | LOAD | Read source block address/ITEM number | Takes a logical AND of the status of the contact and the current execution condition. | O | O |
| AND NOT | | LOAD NOT | Read source block address/ITEM number | Reverses the status of the contact and takes a logical AND with the current execution condition. | O | O |
| OR | | Draw Line | Read source block address/ITEM number | Takes a logical OR of the status of the contact and the current execution condition. | O | O |
| OR NOT | | Draw Line | Read source block address/ITEM number | Reverses the status of the contact and takes a logical OR with the current execution condition. | O | O |
| AND LOAD | | Draw Line | 000000 (fixed) | Takes a logical AND between circuit blocks. | O | O |
| OR LOAD | | Draw Line | 000000 (fixed) | Takes a logical OR between circuit blocks. | O | O |
| OUT | | OUT | Write destination block address/ITEM number | Outputs the result (execution condition) of logical processing: 0 (OFF) at condition 0 (OFF), and 1 (ON) at condition 1 (ON). | O | O |
| OUT NOT | | OUT NOT | Write destination block address/ITEM number | Outputs the result (execution condition) of logical processing: 1 (ON) at condition 0 (OFF), and 0 (OFF) at condition 1 (ON). | O | O |

| Command | Icon | Select Mode menu | Operand | Description | O: Can be used --: Cannot be used | |
|-------------|---|------------------|---|---|--------------------------------------|------------------|
| | | | | | In logic sequence | In step sequence |
| SET |  | SET | Write destination block address/ITEM number | SET turns the operand bit 1 (ON) when the execution condition is 1 (ON), and does not affect the status of the operand bit when the execution condition is 0 (OFF). Use RESET to turn OFF a bit that has been turned ON with SET. | O | O |
| RESET |  | RESET | Write destination block address/ITEM number | RESET turns the operand bit 0 (OFF) when the execution condition is 1 (ON), and does not affect the status of the operand bit when the execution condition is 0 (OFF). Use SET to turn OFF a bit that has been turned ON with RESET. | O | O |
| DIFU |  | DIFU | Write destination block address/ITEM number | Outputs 1 (ON) for one operation cycle only when the execution condition goes to 1 (ON) from 0 (OFF). | O | O |
| DIFD |  | DIFD | Write destination block address/ITEM number | Outputs 1 (ON) for one operation cycle only when the execution condition goes to 0 (OFF) from 1 (ON). | O | O |
| STEP |  | STEP | Step number | STEP declares the step number, and has no input conditions (is a direction connection to the bus). Any numbers in the range 00 to 99 are used as the step number, and are placed in ascending order. 1) Logic sequence: The step number is fixed at 00, and is functional at all times. Declaration of step number 00 can be omitted. 2) Step sequence: When the step number is within the range 01 to 99, only one of the steps is functional. When the program is started, step number 01 is functional. | O | O |
| BLOCK SET |  | BLOCK SET | Block address/step number | When the input conditions turn ON, operation of the specified step number of the Step Ladder Program block at the specified block address (400 to 499) is started. Run/stop command S1 of the specified block turns automatically 1 (ON). Operation of currently executing steps in already operating Step Ladder Program blocks is interrupted, and execution of the program jumps to the specified step. | --- | O |
| BLOCK RESET |  | BLOCK RESET | Block address | When the input conditions turn ON, operation of the Step Ladder Program block is stopped at the specified block address (400 to 499). Run/stop command S1 of the specified block automatically turns 0 (OFF). | --- | O |
| JUMP |  | JUMP | Block address/step number | When the input conditions turn ON, execution of the program jumps to the specified step number (01 to 99) of the Step Ladder Program block at the specified block address (400 to 499). • To specify a jump to the self step number, set the block address to 000. • When a jump is made to another Step Ladder Program block, run/stop command S1 of the source block automatically turns 0 (OFF), and run/stop command S1 of the destination block turns 1 (ON). | - | O |

| Command | Icon | Select Mode menu | Operand | Description | O: Can be used -: Cannot be used | |
|-----------------|---|------------------|--|---|-------------------------------------|------------------|
| | | | | | In logic sequence | In step sequence |
| TIM (See note.) |  | TIM | Block address, timer number, timer setting (seconds) | When the input conditions turn ON, the incrementing timer (T01 to T10) for the specified block address is started. One step ladder program can contain up to twenty timers. ITEMS 010 to 020 for the step ladder block to which the timer is associated can be used for timeout detection. The present timer values can be confirmed by confirming operation of the step ladder. The present value and set value are displayed under the TIM command in the Validate Action Window. | O | O |
| STEP TIMER |  | STEP TIMER | Timer setting value | This is the timer (setting range: 0 to 9999 sec) for moving between steps. It has no input conditions. (STEP TIMER is placed in the same line as the STEP command.) Operation is started when program execution moves to the line containing the STEP command. When the time set by STEP TIMER is reached, the program execution moves to the next step. Note: "Input condition commands" are given top priority. | - | O |
| ALARM TIMER |  | ALARM TIMER | Timer setting value | This is the timer (setting range: 0 to 9999 sec) for monitoring steps. It has no input conditions. (ALARM TIMER is placed in the same line as the STEP command.) Operation is started when program execution moves to the line containing the STEP command. When the time set by ALARM TIMER is reached, the Step Timer Completion flag (step congestion indicator) turns 1 (ON). At this time, the step is held at the current values. | - | O |
| END | | ED | | Indicates the end of a program. Note: The END instruction is automatically placed at the end of program when the Step Ladder Program block is prepared using CX-Process Tool. It is placed after STEP00 when the program comprises STEP00 only, and is placed after the nth STEP where the program ends. | O | O |

Note The TIM command can be used with LCB□□ projects of Ver. 3.0 or later. Refer to the *Loop Control Board Operation Manual* (Cat. No. W406) for details on the TIM command.

3-7-5 Other Icons

| Icon | Select Mode Menu command | Description | In logic sequence | In step sequence |
|---|-----------------------------|--|-------------------|------------------|
|  | Draw Line | Connects vertical or horizontal lines. | OK | OK |
|  | Delete Line | Deletes vertical or horizontal lines. | OK | OK |
|  | Convert Ladder to Mnemonics | Converts step ladder programs created in ladder diagrams to mnemonics. | OK | OK |
|  | Convert Mnemonics to Ladder | Converts step ladder programs created in mnemonics or uploaded mnemonics into ladder diagrams. | OK | OK |
|  | Display Data Name | Displays an explanation of the address (ITEM). | OK | OK |
|  | Annotation | Inserts an annotation (user-set comment). | OK | OK |

3-8 Creating Sequence Tables

Use the following procedure to create a Sequence Table Block (block model: 302).

This operation is supported for LCB05 and LCB05D only.

- Note** 1. Before creating a sequence table, always select *00-LCB05* or *00-LCB05D* in the dialog box displayed for **Settings/Insert/Insert LCB/LC001**.

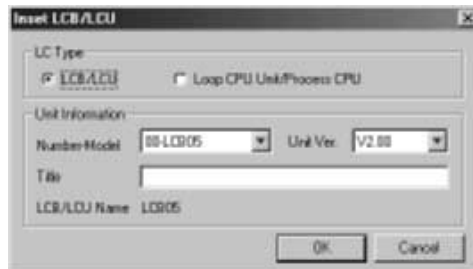

2. To convert a 00-LCB01 to a 00-LCB05 once 00-LCB01 has been selected, use the appropriate **Change LCB Type** command from the Execution Menu and then click the **OK** Button.

3-8-1 Creating a Sequence Table

- 1, 2, 3...** 1. Right-click the **03.Sequence Control** folder and select **Settings/Insert/Insert Function Block**. An Insert Sequence Control Block Dialog Box will be displayed.

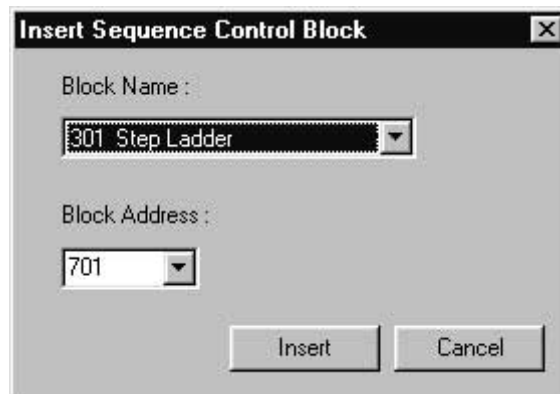

2. From the sequence block names, select **302 Sequence Table**. A **701.Sequence Table** will be created in the Sequence Control folder.

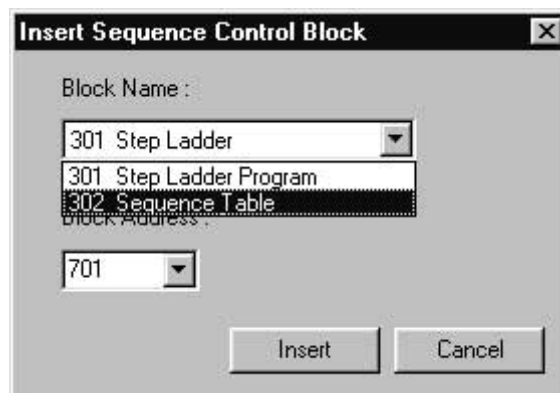

- Double-click the **701. Sequence Table**. The sequence table will be displayed on the right side of the window.

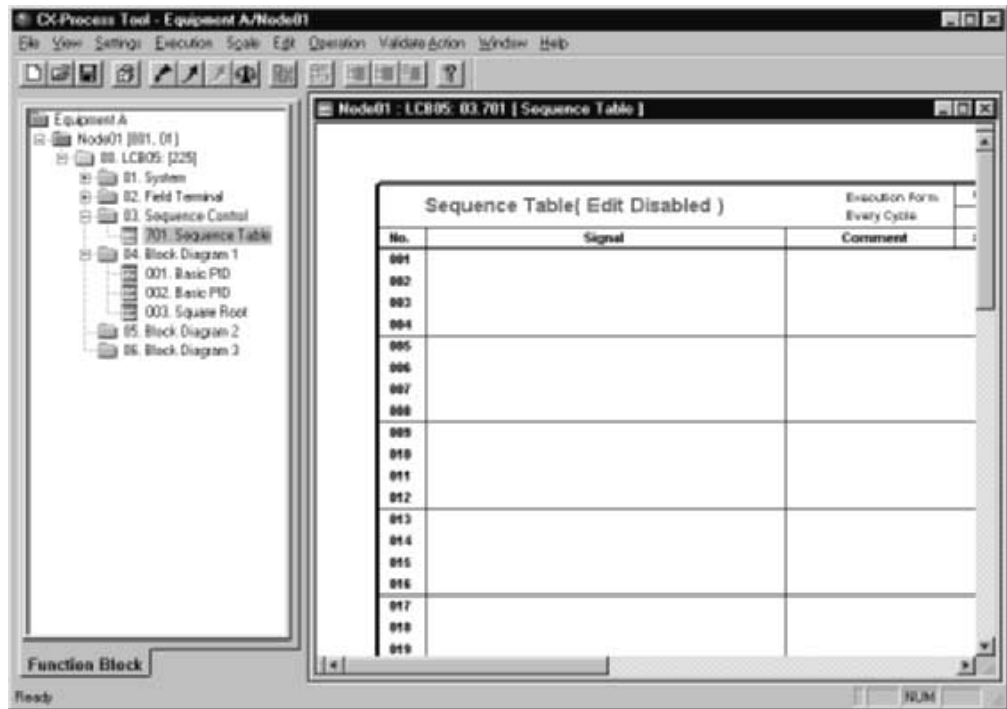

By default, the sequence table is set so that editing is disabled. (*Sequence Table (Edit Disabled)* will be displayed in red.) To edit the sequence table, right-click on it and select **Edit Mode/Enabled**.

3-8-2 Names of Sequence Table Elements

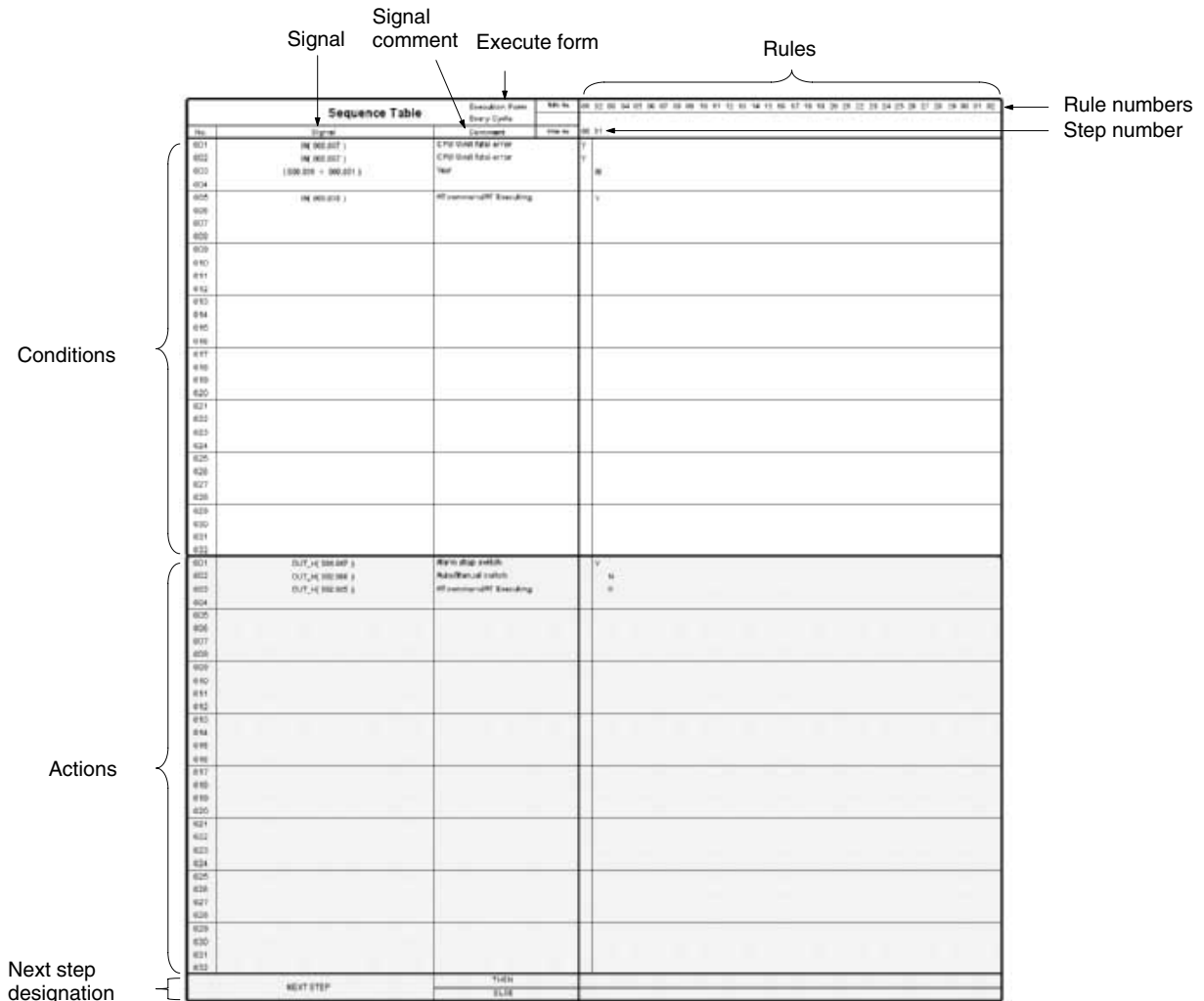

3-8-3 Setting Execution Forms

Right-click and select **Execute Form** and then **Every Cycle**, **Start by S1**, **Start Only First Cycle**, or **Not Execute** from the pop-up menu.

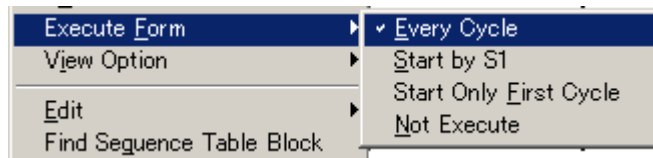

3-8-4 Zooming In and Out of a Sequence Table

Right-click and select **Scale** and then **100%**, **200%**, **50%**, **Zoom In**, or **Zoom Out** from the pop-up menu.

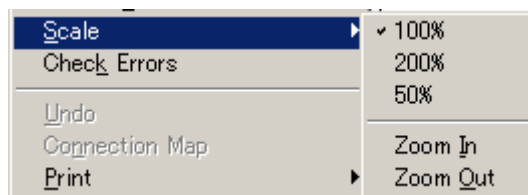

3-8-5 Editing Sequence Tables

- 1, 2, 3... 1. Right-click on the sequence table in the right side of the window and select **Edit Mode/Enabled**. The sequence table will be changed to Edit Mode. (*Sequence Table* will be displayed in black.)

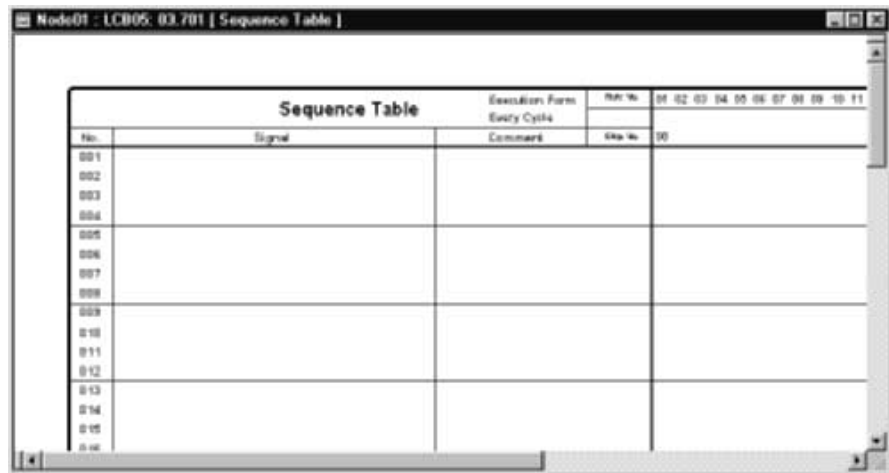

2. Double-click a row in the conditions or actions section, or select the row and select **Data Edit/Signal Name** from the pop-up menu. The Signal Dialog Box will be displayed.

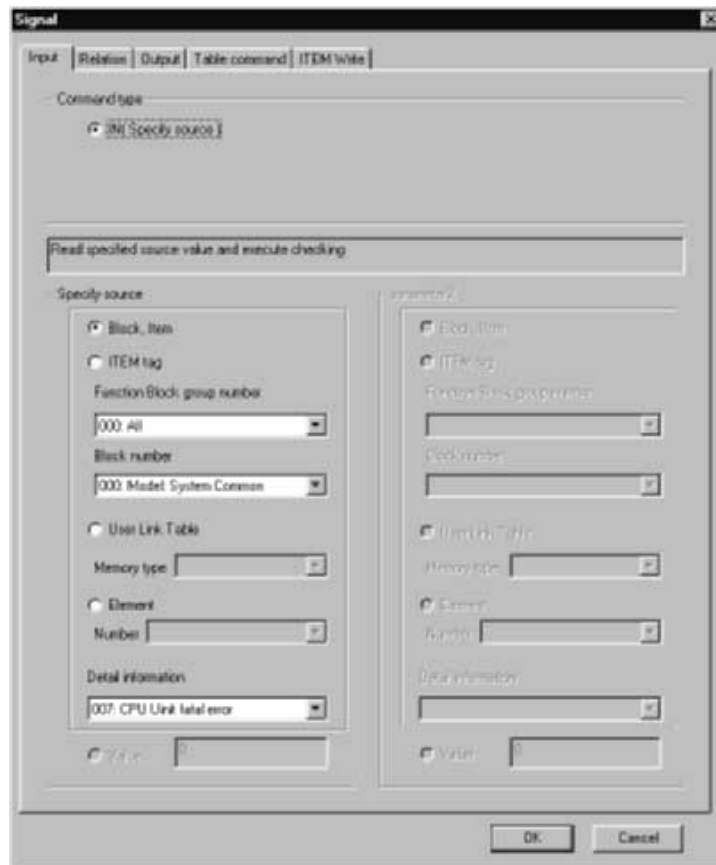

3. Select the **Input, Relation, Output, Table Command, or ITEM Write** Tab, and set a signal in the *Signal* field for a condition or action. Refer to the following tables in 3-8-6 *Settings for Conditions and Actions* for details.

Note Timers and counters must be set in advance in Element Edit Mode before they can be set. Refer to 3-8-7 *Editing Elements* for details.

- Set values for the signal in the rule column of the condition and action sections.

| No. | Signal | Comment | Value |
|-----|-----------------------|-------------------------|-------|
| 001 | (N) 000.010 | Run StartTag | Y |
| 002 | (N) T1000.H | | |
| 003 | (N) 000.011 + 000.001 | Year | N |
| 004 | | | |
| 005 | (N) 001.005 | AT command/RT Executing | Y |
| 006 | | | |
| 007 | | | |
| 008 | | | |
| 009 | | | |

3-8-6 Settings for Conditions and Actions

Conditions

The following contact signals can be used for sequence table conditions.

| Signal | Notation on CX-Process screen | Types | Settings on CX-Process screen | Setting method | Example |
|-----------------------|--|---|---|---|---|
| Input | IN (source specification) | Contact input or contact output ITEMS from function blocks | Input Tab Page source specification: Block and ITEM | Select the block and ITEM and select the ITEM number from the detailed information. | For block address 001 and ITEM 086: 001.086 |
| | | CSV tag and tag ITEM (contact input or contact output ITEM for control or operation block) | Input Tab Page source specification: Tag name. | Select the ITEM tag and select the ITEM from the detailed information. | For the A/M switch for the Master01 CSV tag: Master01.A_M |
| | | User link table tag name (I/O memory in CPU Unit) | Input Tab Page source specification: User link table | Select the area type and select the user link table tag name from the detailed information. | For SW01 user link table tag: LNK007:SW01 |
| | | Timer/counter completion status or status contact, such as a pre-alarm status contact for a timer/counter | Input Tab Page source specification: Element | Specify the timer/counter number and select the status contact from the detailed information. | --- |
| Relational Expression | <p>(parameter 1) < (parameter 2)</p> <p>(parameter) < #(value)</p> <p>"<" can be replaced with other comparison symbols</p> | Result of comparison for relational expression | <p>Relational expression types are set in the command classification on the Relation Tab Page.</p> <p>The same settings are possible for parameters 1 and 2 as for the inputs listed above, i.e. Block and ITEM, tag name., user link table, or element), or a value (constant) can be set.</p> | <p>Set the relational expression (<, <=, NOT, =, >, or >=) parameter 1, and parameter 2.</p> <p>For elements, specify the number and then select the present value of the PV, the remaining time, or the counter value.</p> | For a user link table tag type value equals 200: (LNK005:type = #200) |

Actions

The following contact signals can be used for sequence table outputs.

| Signal | Notation on CX-Process Tool screen | Types | Settings on CX-Process Tool screen | Setting method | Example |
|-----------------------|--|--|--|--|--|
| Output (See note.) | OUT_H (<i>destination</i>): Holding contact output operation | Function block contact output item | Output tab destination specification: Block ITEM | Select the block ITEM and select the ITEM number from the detailed information. | For block address 001 and ITEM 086: 001.086 |
| | OUT_L (<i>destination</i>): Non-holding contact output operation | CSV tag and tag ITEM (Contact output ITEM for control and operation blocks) | Output tab destination specification: Tag name | Select the ITEM tag and select the tag ITEM from the detailed information. | For the A/M switch for the Master01 CSV tag: Master01.A_M |
| | OUT_P (<i>destination</i>): Pulse contact output operation | User link table name (I/O memory in CPU Unit) | Output tab destination specification: User link table | Select the block ITEM and select the ITEM number from the detailed information. | For Value1 user link table tag: LNK007:Value01 |
| | OUT_F (<i>destination</i>): Flashing contact output operation | Timer/counter reset start, operation start/stop, and pause commands | Output tab destination specification: Element action (destination) | Select the area type and select the link table tag name from the detailed information. | --- |
| Table Command | STEP(<i>sequence table block address,step number</i>) | Setting of a specific step in another sequence table | Table Command Tab command classification: STEP(<i>block address, step number</i>) | Block address and step number | For block address 702, step 03: 70203 |
| | RUN(<i>sequence table block address</i>) | Starting another sequence table | Table Command Tab command classification: RUN(<i>block address</i>) | Block address | For block address 702: 702 |
| | STOP(<i>sequence table block address</i>) | Stopping another sequence table | Table Command Tab command classification: STOP(<i>block address</i>) | Block address | For block address 702: 702 |

| Signal | Notation on CX-Process Tool screen | Types | Settings on CX-Process Tool screen | Setting method | Example |
|---------------|------------------------------------|--|---|---|---------|
| Write to ITEM | SET (#value, destination) | Writing a constant to a function block ITEM write parameter | ITEM Write tab destination: Block ITEM | Select the block ITEM, select the ITEM number from the detailed information, and input the write data (-32,000 to 32,000). | --- |
| | | Writing a constant to an CSV tag and tag ITEM (Contact output ITEM for control and operation blocks) | ITEM Write tab destination: Tag name | Select the ITEM tag, select the tag ITEM from the detailed information, and input the write data (-32,000 to 32,000). | --- |
| | | User link table (writing a constant to I/O memory in the CPU Unit) | ITEM Write tab destination: User link table | Select the area type, select the user link table tag from the detailed information, and input the write data (-32,000 to 32,000: Input the scaled value for the user link table). | --- |

Note The following output forms can be selected.

| Signal | Output form | Setting screen on CX-Process Tool | Sequence table execute form (ITEM 006) | | Y/N specification in rule | Execution condition |
|--------|-------------|--|--|--------------------------------|--|--|
| | | | For Every Cycle (0) and Start on S1 (1) | For Start Only First Cycle (2) | | |
| Output | Holding | Output tab command classification: OUT_H (destination) | Y: ON when the condition is met and remains ON even when the condition is no longer met. Must be turned OFF from another rule. N: OFF when the condition is met and remains OFF even when the condition is no longer met. Must be turned ON from another rule. | | Y (ON) or N (OFF) | When condition changes from not met to met |
| | Non-holding | Output tab command classification: OUT_L (destination) | Y: Remains ON while condition is met and remain OFF while condition is not met. N: Cannot be specified. | Cannot be used. | Only Y (always ON) | While condition is met |
| | Pulse | Output tab command classification: OUT_P (destination) | Y: ON only once when condition is met and turns OFF the next operating cycle. The condition must be not met and then met again before the signal will turn ON again. N: Cannot be specified. | Cannot be used. | Only Y (pulse output) | When condition changes from not met to met |
| | Flashing | Output tab command classification: OUT_F (destination) | Y: Changes between ON and OFF when the condition is met and continues flashing even when the condition is no longer met. N: The flashing output is turned ON while the condition is met and remains ON even when the condition is no longer met. Note: To turn OFF and output that is being held ON, Use OUT_H with an N specification. Even when this is done, however, the signal will not turn OFF until the condition for OUT_F is no longer met (for both a Y and N specification). | Cannot be used. | Y (flashing) or N (remains ON when flashing stops) | While condition is met |

3-8-7 Editing Elements

The following procedure must be performed in order to use timers and counters. When editing the sequence table, **Element** must be selected in the Signal Dialog Box to display the elements set with this procedure and enable using them.

- 1, 2, 3... 1. Right-click the sequence table and select **View Mode/Element** from the pop-up menu to switch to Element Edit Mode.

2. Select a row and select **Data Edit/Element** from the menus. The Initial Data Configuration Dialog Box will be displayed.



3. Values are set for the timers and counters. The settings are shown in the following table.

| Element type | Set value | Pre-alarm value | Unit | System element number | Registered block address | Example |
|--------------|------------|-----------------|-----------------------------------|-----------------------|--------------------------|--------------------|
| Timer | 0 to 32767 | 0 to 32767 | 1: 0.01 s, 2: 0.1 s, 2: s, 4: min | Automatically set | Sequence table address | TIM 000 100 s |
| Counter | 0 to 32767 | 0 to 32767 | --- | | | CNT 001 200 counts |

3-8-8 Expanding the Sequence Table

Right-click and select **Expand/Vertical** or **Expand/Horizontal** from the pop-up menu. When a sequence table is expanded, the sequence table will be automatically expanded by the specified amount in descending order starting from block address 900.

- Note**
1. The expanded portion of the sequence table cannot be edited directly. When editing a sequence table edit the portion from the original table that existed before expansion.
 2. When sequence table expansion is cleared, the expanded portion of the table is deleted automatically.

The table above shows the relationship between the main table and the reference table. The evaluation results for the conditions set in the reference table are treated as the condition signals for the main table. For details on the table reference function, refer to the *Loop Control Boards Operation Manual* (Cat. No. W406).

Creating the Reference Table

Use the following procedure to create the reference table.

- 1, 2, 3... 1. Register a sequence table.
2. Double-click the sequence table that is to be the reference table in the Workspace tree. The Sequence Table Window will open.
3. Right-click in the Sequence Table Window and select **Reference Setting – Reference Table** from the pop-up menu or select **Operation – Reference Setting – Reference Table** from the main menus.

Using the Reference Table in the Main Table

Use the following procedure to set the main table to access input signals from the reference table.

- 1, 2, 3... 1. Display the Signal Dialog Box in the main table.
2. Select the **Input** Tab and select **TBL** as the command type.
3. Set the reference table as the source.

Clearing the Reference Table Setting

Use the following procedure to clear the reference table setting by setting the table as a main table.

- 1, 2, 3... 1. Double-click the reference table in the Workspace. The reference table will open.
2. Right-click in the Sequence Table Window and select **Reference Setting – Main Table** from the pop-up menu or select **Operation – Reference Table – Main Table** from the main menus.

3-8-10 Checking for Errors in the Sequence Table

Right-click and select **Check Errors** from the pop-up menu.

Note The sequence table can be downloaded to the Loop Controller even if the above check finds errors. Before downloading a sequence table with errors, confirm that the error will not affect normal control operation.

Sequence tables can be transferred to the Loop Controller even if errors have been detected in them in the error check. If transferring a sequence table with an error, first make sure that the error will not affect control operations before performing the transfer.

An error will occur in the following cases and the transfer will not be made to the LCB.

- The condition or operation signal is undefined and there is only Y/N data.
- The timer cycle is shorter than the operation cycle of the sequence table.
- There is no step number specified using THEN and ELSE.
- There is no step number specified using the STEP command in the referent sequence table N is specified for the non-holding output, pulse output, STEP command, RUN command, STOP command, and ITEM writing.
- The block address of a sequence table is specified in a STEP command, RUN command, or STOP command within that sequence table.
- A TBL command is set in a reference table.
- The block address of a sequence table is specified in a TBL command within that sequence table.

- The block address specified for a TBL command does not exist.

A warning will be displayed while downloading a sequence table in the following cases. Downloading will continue.

- A input signal is not registered in the reference table with the block address specified for a TBL command in the main table.
- Y/N data is not registered in the reference table for the block address specified for a TBL command in the main table.
- An output signal is registered in the reference table.
- The block address specified for the TBL command is not set as a reference table.

3-8-11 Validating the Actions of the Sequence Table

Right-click and select **Validate Action/Start** from the pop-up menu. The sequence table can be edited online during validation. Refer to *4-6-7 Validating Sequence Table Operation* for details.

3-8-12 Printing the Sequence Table

Right-click and select **Print/General** from the pop-up menu.

3-9 Displaying and Setting in Engineering Units

3-9-1 Overview

Engineering units can be used to display and set the analog data handled by the CX-Process Tool. Data is converted to engineering units based on the CSV tag information set for the function block.

Note This function can be used only with Loop Control Boards, Loop-control CPU Units, and Process-control CPU Units. It is not supported by Loop Control Units.

Configuration for Engineering Unit Conversion

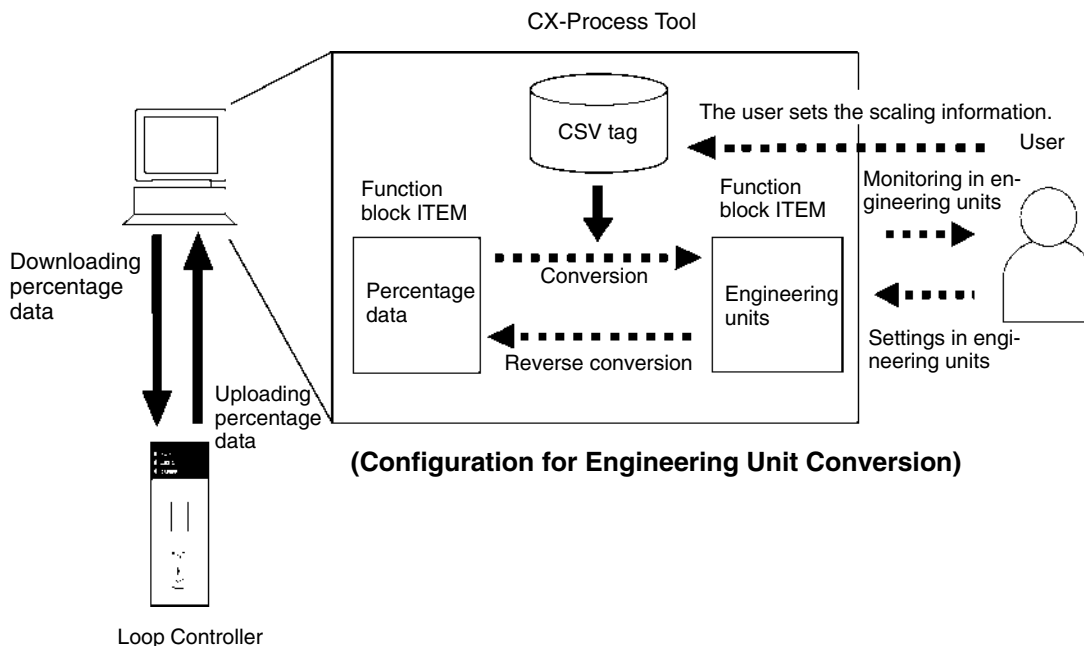

The above diagram shows the configuration for using the engineering unit display and setting function to convert Loop Controller parameters into engineering units.

Engineering units are values that have been converted into the values actually used for I/O based on scaling of ITEM data handled by the Loop Controller. They are applicable to values such as temperatures (°C) and voltages (Pa). Conversely, the main analog data handled by the Loop Controller (e.g., PV or SP for basic PID) is expressed in values such as -15.00% to +115% or -320.00% to +320%. This is called percentage (%) data.

The CX-Process Tool converts function block ITEM displays into engineering units based on CSV tags set by the user. Displays and settings on the CX-Process Tool can use engineering units when the engineering unit display and setting function is enabled, making it possible to check and input values more intuitively. (When this function is disabled, or when CSV tags are not set, editing is only possible for percentage (%) data.)

When the CX-Process Tool exchanges data with the Loop Controller, it is percentage (%) data that is transferred. Loop Controller internal processing is executed using percentage (%) data, so reverse conversion from engineering units to percentage (%) data is performed automatically when data is transferred.

Conversion Errors

The main analog data is processed as percentage data in the Loop Controller. The maximum resolution for this data is 64,000. Depending on the scaling set-

tings, conversion errors may occur during engineering unit conversion. If a conversion error occurs with the CX-Process Tool, the following warning will be displayed when the value is input. (When a conversion error occurs, the scaled value closest to the input value is automatically calculated.)



(Conversion Error Warning Display)

With the CX-Process Tool, an engineering unit that is input is converted to a percentage (%) value. The converted value is converted back to the engineering unit (reverse conversion), and the two values are compared. If there is a difference, a warning is displayed. The main cause of errors is rounding errors that occur in division during scaling.

Conversion Error Example

When the following settings are made for the CSV tag:
 Scaling upper limit: 8,500, Scaling lower limit: -2,000, DP position: 1, Unit: °C
 An input value of 32.0C becomes 2,209.52 when converted to percentage (%) data. The rounded-off value of 2,210 then becomes 32.05°C when converted back to the engineering unit. The rounded-off value with a DP position of 1 becomes 32.1C, and a warning is displayed because this value differs from the input value.

3-9-2 Functions for Which Engineering Unit Displays and Settings Are Enabled

The following table shows the functions for which engineering unit displays and settings are enabled.

Functions for Which Engineering Unit Displays and Settings Are Enabled

| Function name | Displays | Settings |
|---|----------|----------|
| Editing function block ITEMS | Yes | Yes |
| Printing and print previews for function block ITEMS | Yes | --- |
| Monitor ITEM lists | Yes | Yes |
| Block diagram operation checks | Yes | Yes |
| Wireless debugging | Yes | Yes |
| Segment Program 2 and Segment Program 3 ITEM settings | Yes | Yes |

3-9-3 Setting CSV Tags for Function Blocks

CSV tags must be set for a function block in order to execute the engineering unit display and settings. For details on setting CSV tags, refer to *3-4-1 Creating SCADA Software and RS View Tag Files*.

3-9-4 Setting Projects in Engineering Unit Mode

Select **View - Engineering Unit Mode - Display** from the menu, or click the  Icon in the toolbar. To clear the Engineering Unit Mode, select the command again or click the icon again.

The default setting is for the Engineering Unit Mode to be enabled. Setting the Engineering Unit Mode enables engineering unit displays and settings for all function blocks registered for the project.

Note The enable/disable status for the Engineering Unit Mode is held from the previous time that the CX-Process Tool was started.

3-9-5 Displaying Function Block ITEM Lists

When the Engineering Unit Mode is enabled, converted ITEMS in the ITEM list are displayed in blue. The values are displayed as engineering units and right-justified in the *Data* column in the ITEM list.

| ITEM | Type | ITEM tag | Data | Data Name |
|--------------------|------|----------|--------|---------------------------------|
| < Operation data > | | | | |
| D00 | O | HH_SP | 115.00 | High/high alarm setting |
| D09 | O | H_SP | 100.00 | High alarm setting |
| D10 | O | L_SP | 0.00 | Low alarm setting |
| D11 | O | LL_SP | -15.00 | Low/low alarm setting |
| D17 | O | ACF | 0 | Alarm stop switch |
| D23 | O | SP_W | 0.00 | Local Set Point setting |
| D26 | O | RL_SW | 0 | Remote/Local switch |
| D35 | O | AT | 0 | AT command/AT Executing |
| D36 | O | CYCL_OUT | 20.00 | Limit cycle MV amplitude |
| D37 | O | CYCL_HS | 0.20 | Limit cycle hysteresis |
| D38 | O | AT_GAIN | 1.00 | AT calculation gain |
| D39 | O | AT_DEV | 10.00 | Judgment DEV for provisional AT |
| D40 | O | AT_TYP | 0 | AT type |
| D41 | O | DVA_SP | 115.00 | Deviation alarm setting |
| D53 | O | DIR_CHG | 0 | Direction onnd |
| D54 | O | P | 100.0 | Proportional band |
| D55 | O | I | 0 | Integral time(0: No action) |
| D56 | O | D | 0 | Differential time(0:No action) |
| D65 | O | ALFA | 0.65 | 2-PID parameter alpha |
| D66 | O | BETA | 1.00 | 2-PID parameter beta |

(ITEM List Display (Basic PID) with Engineering Unit Mode Disabled)

| ITEM | Type | ITEM tag | Data | Data Name |
|--------------------|------|----------|-----------|---------------------------------|
| < Operation data > | | | | |
| D00 | O | HH_SP | 115.00 °C | High/high alarm setting |
| D09 | O | H_SP | 100.00 °C | High alarm setting |
| D10 | O | L_SP | -2.00 °C | Low alarm setting |
| D11 | O | LL_SP | -21.00 °C | Low/low alarm setting |
| D17 | O | ACF | 0 | Alarm stop switch |
| D23 | O | SP_W | -2.00 °C | Local Set Point setting |
| D26 | O | RL_SW | 0 | Remote/Local switch |
| D35 | O | AT | 0 | AT command/AT Executing |
| D36 | O | CYCL_OUT | 20.00 | Limit cycle MV amplitude |
| D37 | O | CYCL_HS | 0.20 | Limit cycle hysteresis |
| D38 | O | AT_GAIN | 1.00 | AT calculation gain |
| D39 | O | AT_DEV | 13.20 °C | Judgment DEV for provisional AT |
| D40 | O | AT_TYP | 0 | AT type |
| D41 | O | DVA_SP | 115.00 °C | Deviation alarm setting |
| D53 | O | DIR_CHG | 0 | Direction onnd |
| D54 | O | P | 100.0 | Proportional band |
| D55 | O | I | 0 | Integral time(0: No action) |
| D56 | O | D | 0 | Differential time(0:No action) |
| D65 | O | ALFA | 0.65 | 2-PID parameter alpha |
| D66 | O | BETA | 1.00 | 2-PID parameter beta |

(ITEM List Display (Basic PID) with Engineering Unit Mode Enabled)

3-9-6 Editing Function Block ITEMS

Use the following procedure to input analog data using engineering data.

- 1, 2, 3... 1. Enter the Engineering Unit Mode as described in 3-9-4 *Setting Projects in Engineering Unit Mode*.
2. Open the ITEM Setting Window and click on the *General Data* input area.
3. The Engineering Input Dialog Box will be displayed. Input the value.



4. If a conversion error occurs, a warning will be displayed. After confirmation, the rounded value will be set.

3-9-7 Displaying Engineering Units When Confirming Operation

Displaying Monitor ITEM Lists

Engineering unit display and settings are enabled in the monitor ITEM list. The notation is the same as for the ITEM list shown in 3-9-5 *Displaying Function Block ITEM Lists*. In addition, when the monitor ITEM list is executed, ITEM data transfer editing is enabled in engineering units.

Note For details on ITEM data transfers, refer to 4-6-2 *Downloading Individual ITEM Data Settings*.

Displays in Block Diagrams

When checking operation in a block diagram, the ITEM values are displayed in engineering units. The display can include integers, a decimal point, and a total of up to five characters for the unit.



(Engineering Unit Display When Checking Operation)

If there is more information than can be displayed in the diagram, it can be viewed in a tool chip when the cursor is over the function block, as shown below.



(Engineering Unit Display in Tool Chip Format)

Engineering units can also be set for forced changes to analog output signals while checking function block operation.

Note For details on forced changes, refer to 4-6-5 *Forced Changes to Analog Output Signals*.

Setting Engineering Units for Wireless Debugging

Engineering units can be used for numeric inputs for wireless debugging.

Note For details on the wireless debugging function, refer to 4-6-4 *Wireless Debugging (LCB Ver. 3.0 or Later Only)*.

3-9-8 Related Functions

Print Preview and Printing

When the Engineering Unit Mode is enabled, data strings in the ITEM list are printed in engineering units when the ITEM list is printed. The data strings are displayed as right-justified engineering units shown with the units included (in the same positions as in the ITEM list).

ITEM Setting Dialog Box for Segment Program 2 and Segment Program 3 Blocks

The ITEM setting dialog boxes for Segment Program 2 and Segment Program 3 blocks can be set using an engineering unit display.

Note For details on ITEM settings for Segment Program 2 and Segment Program 3 blocks, refer to *Appendix C Setting Segment Programs*.

3-10 Displaying Loop Controller Memory Maps

3-10-1 Overview

When using CX-Process Tool version 4.0 or higher, a list can be displayed showing the areas of the CPU Unit's I/O memory that are being used by the Loop Controller. The list is displayed for each area type in address order. The following areas can be displayed and the status can be confirmed by the color of the address cell.

- When HMI I/F Area is allocated:
Send Area (Loop Controller → CPU): Blue
Receive Area (CPU → Loop Controller): Pink
- When analog or contact signals are allocated in the addresses of the User Link Table: Green
- When analog or contact signals are allocated in the field terminal block: Orange
- When program pattern data is allocated in Segment Program 3 (Block Model 158): Dark green

- Note**
1. For User Link Table contacts, the I/O memory address in which the contact signal is allocated is displayed in color.
 2. The following two types of overlapping can be confirmed when checking whether the same I/O memory address has been used more than once.
 - When data has been written (sent) from the Loop Controller to the same I/O memory address in the CPU Unit: The corresponding cell will be displayed in red to indicate an overlap warning.
 - When data has been read (received) to the Loop Controller from the same I/O memory address in the CPU Unit, or when data has been read (received) from and written (sent) to the same I/O memory address in the CPU Unit: The corresponding cell will be displayed in aqua to indicate an overlap in the receive area.

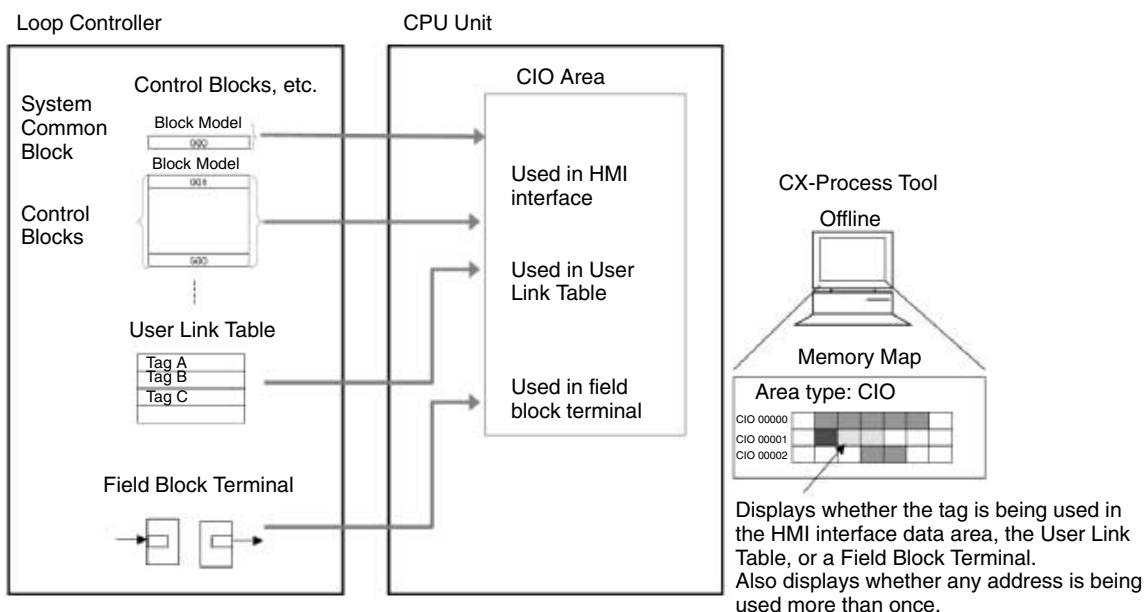

This function simplifies management of the CPU Unit memory by enabling confirmation of which areas in the CPU Unit's I/O memory are being used by the Loop Controller.

3-10-2 Operation Procedure

Use the following procedure to display a list showing the status of which words in the CPU Unit's I/O memory are being used by the Loop Controller.

- 1, 2, 3... 1. Select **Show Memory Map** from the Execute Menu.
2. The Memory Map of LCB Window will be displayed.

3-10-3 Screens

Memory Map Display

- 1, 2, 3... 1. Select the memory area type to be displayed as a list from the pull-down list at the top left of the screen (CIO, W, H, DM, EM bank Nos. 0 to 12).
2. Enter the first word of the memory area in the *Channel* field.
3. The corresponding address cells will be displayed using the following colors. The colors differentiate how each area is being used by the Loop Controller.

| Display color | Loop Controller allocated area |
|---------------|---|
| Green | User Link Table (except field terminals) |
| Blue | HMI I/F Send Area (Loop Controller → CPU) |
| Pink | HMI I/F Receive Area (CPU → Loop Controller) |
| Orange | Field Terminal |
| Red | Overlap (including overlap in data written to the CPU Unit) |
| Aqua | Overlap (Recv. Area) (overlap in data read from CPU Unit) |
| Dark green | Other memory links |

Example 1: Displaying Areas Used for User Link Table

Find Overlapping: Searches for addresses with overlaps.

Reload: Refreshes the list.

Find Overlapping (Whole Area): Displays a list of the overlapping addresses in the Search Result Window.

Bin/Hex.: Switches between binary and hexadecimal.

Checking for Overlapping of Reading attribute: Treats *Overlap (Recv. Area)* as *Overlap*. The function returns to *Overlap (Recv. Area)* when clicked again.

Enter the first word of the selected area to be displayed.

Detail: Displays the details for the selected address in Detail View.

Address with lowest digit 0.

Select the memory area to be displayed: CIO, W, H, DM, EM bank No. 0 to 12.

Indicates the lowest digit as 0 to 9.

Click this field to switch the displayed area.

W300 is used for the User Link Table, so it is displayed in green.

The range currently being displayed is indicated within a green frame.

W302 is displayed in aqua, indicating an overlap (CPU → Loop Controller only) of two or more read links in the User Link Table (*Overlap (Recv. Area)*).

W301 is displayed in red, indicating an overlap (Loop Controller → CPU) of two or more links including write links in the User Link Table.

Memory Map legend: Indicates the colors of the used areas.

Legend items: User Link Table, HMI I/F Send Area, HMI I/F Recv Area, Field Terminal, Overlap, Overlap(Recv Area).

Example 2: HMI I/F Area Display

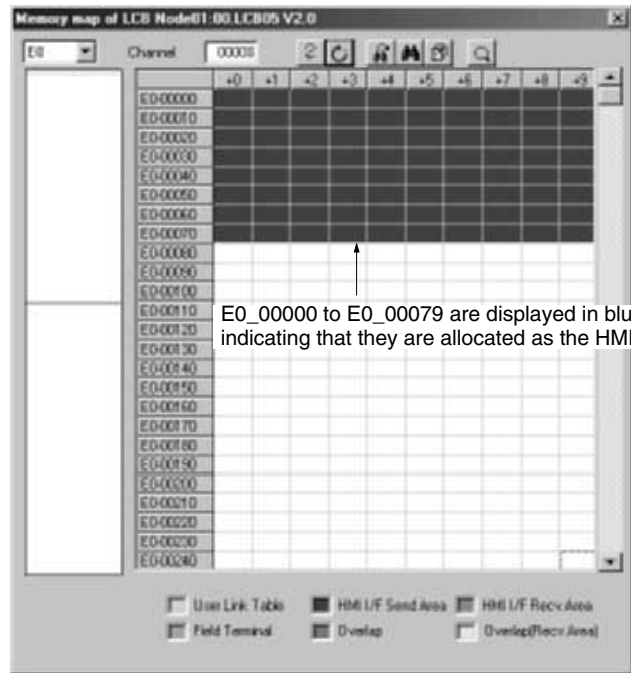

Memory Map Detail

Select the I/O memory word cell in the Memory Map Window, and click the  icon to display the Detail View Window.



Display Items

| Code | Color | Contents | Displayed items |
|------|------------|---|---|
| UL | Green | User Link Table (except field terminals) | Address, Tag Name, ITEM Name, R/W, Link Number |
| HS | Blue | HMI I/F Send Area | Address, Tag Name, ITEM Name |
| HR | Pink | HMI I/F Receive Area | Address, Tag Name, ITEM Name |
| FT | Orange | Field terminal | Address, Tag Name, ITEM Name, R/W |
| OT | Dark green | Other memory links | Address, R/W |

Checking the Result Window (Overlap)

Displays a list of any CPU Unit I/O memory addresses that are overlapping (including overlap in data written to CPU Unit) in the HMI I/F, User Link Table, or Field Terminals to enable checking for overlapping addresses. This can be done using either of the following two procedures.

• **Searching for Overlapping Addresses One at a Time**

Click the  **Find Overlapping** Icon in the Memory Map Display. The first address being used more than once will be displayed. Each time the icon is clicked, the next overlapping address will be displayed.

• **Searching for All Overlapping Addresses at Once**



Next, click the  **Find Overlapping (whole area)** Icon. The following Search Result Window will be displayed showing all of the addresses in I/O memory being used more than once.

Overlap: Displays the number of times the address has been used.

Type: Displays the type code (UL: User Link Table, HS: HMI Send Area, HR: HMI Receive Area, FT: Field Terminal)

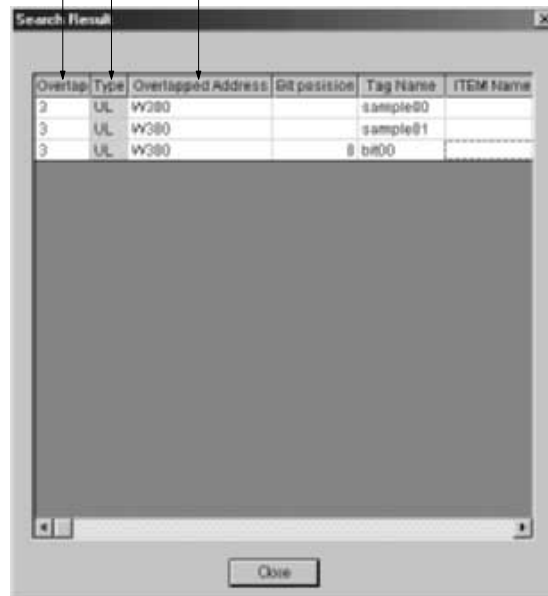
Overlapping Address: Displays the address that is being used more than once by the Loop Controller.



Note To display the Search Result Window treating *Overlap (Recv. Area)* (overlap in data read from CPU Unit) as *Overlap* (including overlap in data written to CPU Unit), click the  **Checking for Overlapping of Reading attribute** Icon, and then click the  Icon.

3-11 Printing

Function blocks, block diagrams, ladder diagrams, the cross-references of step ladder programs, or monitor tag lists can be printed.

Select the ITEM to be printed using the Project Workspace and then select **Print** and the type of data to be printed from the File Menu, or right-click the data that is currently open and select **Print** ○○ from the pop-up menu.

Note Data can be printed vertically (portrait) on A4 only. Do not use any other paper size. Block diagrams, however, can be printed horizontally (landscape) on A4.

3-11-1 Printable Data

| Data | Printable item | Condition for selection | File menu | Pop-up menu |
|--|---|--|------------------------|---|
| Function blocks | Block addresses, block models, block names, and all ITEM settings. Select the desired LCU/LCB element, function block group, or function block. | --- | Print/Function Block | None |
| Block diagrams | Block diagram Note Annotations (comments) can be inserted. | Edit Block Diagram Mode | Print/Block Diagram | Print Block Diagram in Block Diagram Edit Mode |
| Ladder diagrams | Ladder symbols and operands (address) Note Annotations (comments) can be inserted. | Edit Step Ladder Program Mode | Print/Ladder Diagram | Print Ladder Diagram in Ladder Diagram Edit Mode |
| Cross-references of Step Ladder Programs | Cross-references (i.e., contact addresses, block addresses, mnemonic row numbers, instructions, and output comments) | When cross-references are displayed | Print/Cross-References | Print Cross-Reference when cross references are displayed |
| Monitor tag list (Loop Control Units only) | Monitor tag list (i.e., open monitor tag lists, LCB elements, nodes, etc.) | When monitor tag lists are displayed | Print/Monitor Tag List | Print when the monitor tag list is displayed |
| CSV Tag List | CSV tag list (i.e., open CSV tag lists, LCU/LCB elements, or nodes). | When LCU/LCB element or node function block file is selected | Print/CSV Tag List | Print when the CSV tag list is displayed |
| All | All of the above data by LCU/LCB element or node (i.e., function blocks, block diagrams, ladder diagrams, cross-references, and monitor tag lists) | --- | Print/All | None |
| ITEM list | Open ITEM lists | When ITEM lists are displayed | Print/ITEM List | Print when the ITEM list is displayed |
| Sequence Table | Sequence table The entire table will be printed if <i>General</i> is selected. If <i>Separated</i> is selected, expanded portions will be printed on separate pages. | When LCU/LCB element is selected | Print/Sequence Table | Print/Sequence Table |
| User Link Table | --- | When LCU/LCB element is selected | Print/User Link Table | Print/User Link Table |
| Connection Map | --- | When LCU/LCB element or block is selected | Print/Connection Map | Print/Connection Map |

3-11-2 Printing Function Blocks

- 1, 2, 3... 1. Select **Print** and **Function Block** from the File Menu. The following dialog box will appear.

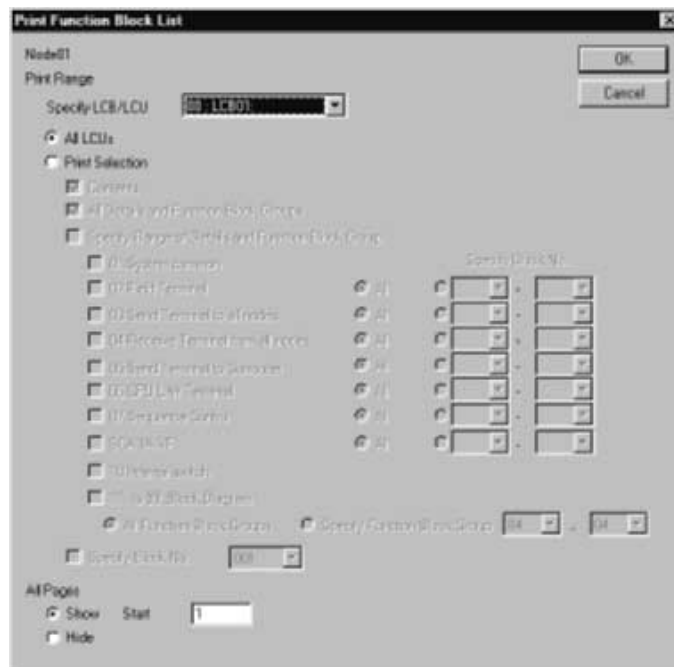

2. Select the LCU/LCB element to print.
3. Click the **OK** Button to print all the LCU/LCB element data.
To print a function block group, select the function block group or the block addresses to be printed.
The following Print Preview Screen will appear.

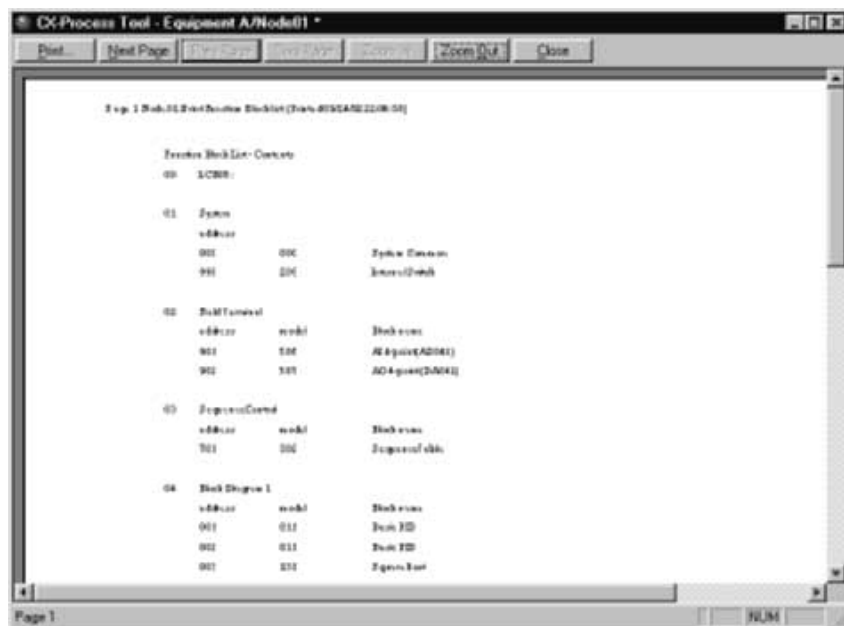

4. Click the **Print** Button to start printing.

Printing Example

Page 1 Mode 01:Print Function Block list (Printed 09/24/02 22:06:38)

| Function Block List - Contents | | | |
|--------------------------------|-----------------|-------|------------------|
| 00 | LCB05: | | |
| 01 | System | | |
| | address | | |
| | 00C | 00C | System Common |
| | 99E | 20E | Internal Switch |
| 02 | Field Terminal | | |
| | address | model | Block name |
| | 901 | 58E | A04-point(A0041) |
| | 902 | 58F | A04-point(DA041) |
| 03 | SequenceControl | | |
| | address | model | Block name |
| | 701 | 302 | SequenceTable |
| 04 | Block Diagram 1 | | |
| | address | model | Block name |
| | 001 | 011 | Basic PID |
| | 002 | 011 | Basic PID |
| | 003 | 131 | Square Root |

3-11-3 Printing Block Diagrams

Printing an Active (i.e., Currently Open) Block Diagram

- 1, 2, 3... 1. Select the block diagram folder and select **Edit/Block Diagram** from the Settings Menu to set the Edit Block Diagram Mode.
2. Right-click the block diagram window, and select **Print Block Diagram** from the pop-menu. The following Print Dialog Box will be displayed.

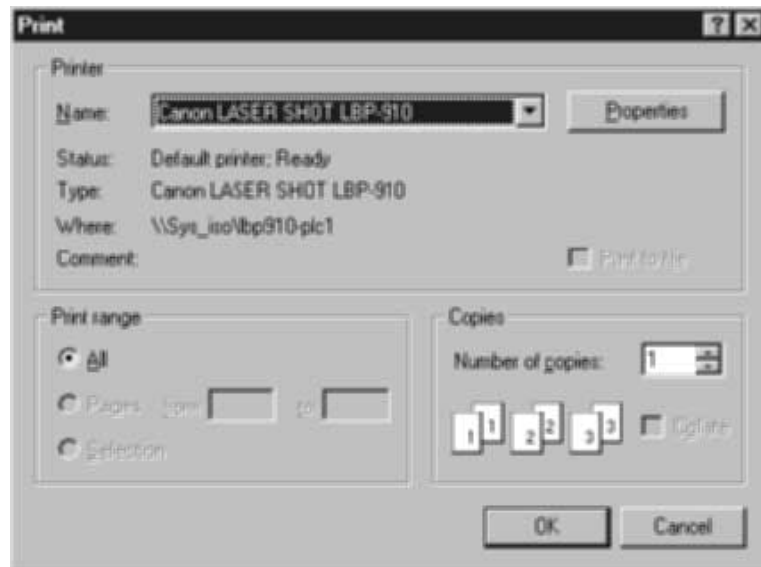

3. Set the number of copies to be printed, and then click the **OK** Button to start printing.

Printing Example

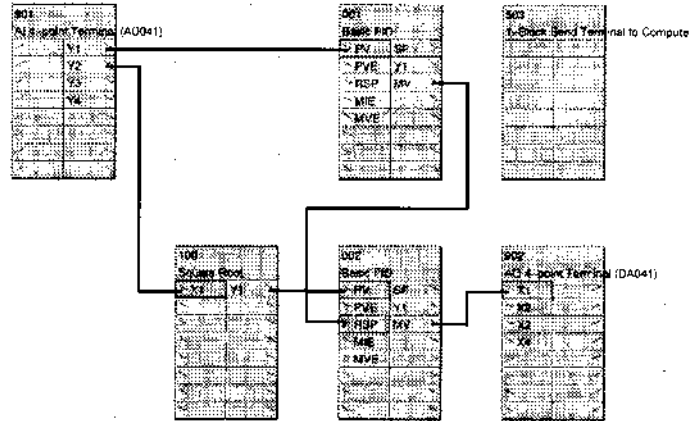

Printing for an LCU/LCB Element

- 1, 2, 3... 1. Select the LCU/LCB element in the Project Workspace, and then Select **Print** and **Block Diagram** from the File Menu. The following dialog box will be displayed.

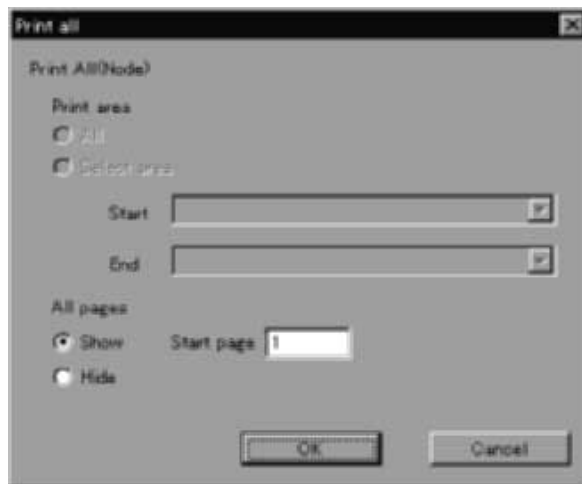

2. To print all the block diagrams within the LCU/LCB element, select the All check box. To select specific block diagrams for printing, select the Select Area check box, and specify the start block diagram and the end block diagram. (Start/End correspond to the start and end block diagram numbers registered in ascending order.) One block diagram will be printed per page. You can also specify the start page. Select the **Show** and **Hide** Buttons on each page to show and hide specific pages.
3. Click the **OK** Button. The block diagrams in active function block files will start printing.

Printing for a Node (Maximum 3 LCU Elements and 1 LCB Element)

- 1, 2, 3... 1. Select the active function block file in the Project Workspace, and then select **Print** and **Block Diagram** in the File Menu.
2. One block diagram will be printed per page. You can also specify the start page. Select the **Show** and **Hide** Buttons on each page to show and hide specific pages.
3. Click the **OK** Button. The block diagrams in active function block files will start printing.

3-11-4 Printing Ladder Diagrams

Printing an Active (i.e., Currently Open) Ladder Diagram

- 1, 2, 3... 1. Select Edit Step Ladder Mode. (Select the step ladder block, and then select Setting and Edit Step Ladder Program.)
2. Right-click the ladder diagram window, and then select **Print Ladder Diagram** from the pop-up menu. The Print Dialog Box will be displayed.
3. Set the number of copies to be printed, and then click the **OK** Button to start printing.

Note If there is more than one ladder diagram, click the **Print** Button for each ladder diagram.

Printing Example

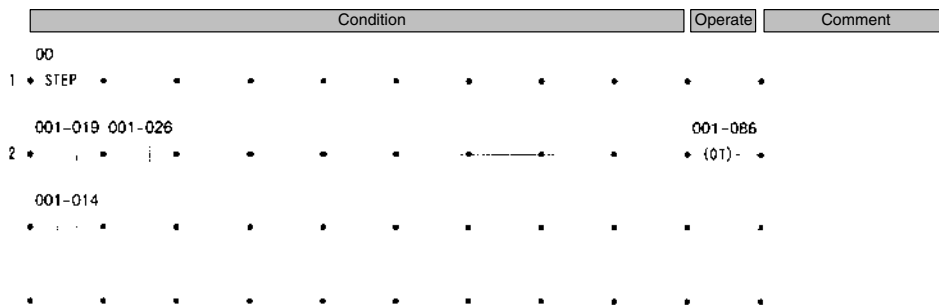

Printing for an LCU/LCB Element

- 1, 2, 3... 1. Select the LCU/LCB element from the Project Workspace, and then select **Print** and **Ladder Diagram** from the File Menu.
2. To print all the ladder diagrams within the LCU/LCB element, select the All check box. To select specific ladder diagrams for printing, select the Select Area check box, and specify the start ladder diagram and the end ladder diagram. (Start/End correspond to the start and end ladder diagram numbers registered in ascending order.) You can also specify the start page. Select the **Show** and **Hide** Buttons on each page to show and hide specific pages.
3. Click the **OK** Button. The ladder diagrams in the LCU/LCB element will start printing.

Printing for a Node (3 LCU Elements and 1 LCB□□ Element)

- 1, 2, 3... 1. Select the active function block files from the Project Workspace, and then select **Print** and **Ladder Diagram** from the File Menu.
2. You can also specify the start page. Select the **Show** and **Hide** Buttons on each page to show and hide specific pages.
3. Click the **OK** Button. The ladder diagrams in active function block files will start printing.

3-11-5 Printing Cross-references

Printing an Active (i.e., Currently Open) Cross-reference

- 1, 2, 3... 1. Display the cross-references. (With the mnemonic code displayed, select the **Refresh** Button, click the **OK** Button, and then select **LCU/LCB**. Next, select **Execution** and **Cross-reference**.)
2. Right-click the cross-reference window, and then select **Print Cross-Reference** from the pop-up window. The Print Dialog Box will be displayed.
3. Set the number of copies to be printed, and then click the **OK** Button to start printing.

Printing Example

| Contact Address | Block Address | Mnemonic | Row No. | Command | Output Comment |
|-----------------|---------------|----------|---------|---------|-------------------------|
| 001014 | 400 | 3 | | OR | H High alarm output |
| 001019 | 400 | 2 | | LOAD | PVE PV error indication |
| 001026 | 400 | 4 | | AND NOT | R/L Remote/Local switch |
| 001086 | 400 | 5 | | OUT | A/M Auto/Manual switch |

Printing for an LCU/LCB Element

- 1, 2, 3... 1. Select the LCU/LCB element from the Project Workspace, and then select **Print** and **Cross-reference** from the File Menu.
2. One cross-reference will be printed per page. You can also specify the start page. Select the **Show** and **Hide** Buttons on each page to show and hide specific pages.
3. Click the **OK** Button. The cross-references in the LCU/LCB element will start printing.

Printing for a Node (3 LCU Elements and 1 LCB□□ Element)

- 1, 2, 3... 1. Select the active function block file from the Project Workspace, and then select **Print** and **Cross-Reference** from the File Menu.
2. One cross-reference will be printed per page. You can also specify the start page. Select the **Show** and **Hide** Buttons on each page to show and hide specific pages.
3. Click the **OK** Button. The cross-references in active function block file will start printing.

3-11-6 Printing Monitor Tag Lists (Loop Control Units Only)

Printing an Active (i.e., Currently Open) Monitor Tag List

- 1, 2, 3... 1. Display the monitor tag lists. (Select **Execution**, and then **Monitor Tag List**.)
2. Right-click the Monitor Tag List Window, and then select **Print Monitor Tag List** from the pop-up menu. The Print Dialog Box will be displayed.
3. Set the number of copies to be printed, and then click the **OK** Button to start printing.

Printing for an LCU/LCB Element

- 1, 2, 3... 1. Select the LCU/LCB element from the Project Workspace, and then select **Print** and **Monitor Tag List** from the File Menu.
2. You can also specify the start page. Select the **Show** and **Hide** Buttons on each page to show and hide specific pages.
3. Click the **OK** Button. The ladder diagrams in the LCU/LCB element will start printing.

Printing for a Node (3 LCU/LCB Elements Maximum)

- 1, 2, 3... 1. Select the active function block file from the Project Workspace, and then select **Print** and **Monitor Tag List** from the File Menu.
2. You can also specify the start page. Select the **Show** and **Hide** Buttons on each page to show and hide specific pages.
3. Click the **OK** Button. The monitor tag lists in active function block file will start printing.

3-11-7 Printing CSV Tag Lists

Printing an Active (i.e., Currently Open) CSV Tag List

- 1, 2, 3... 1. Display the CSV tag lists. (Select **Execution**, and then **CSV Tag List**.)
2. Right-click the CSV Tag List Window, and then select **Print** from the pop-up menu. The Print Dialog Box will be displayed.
3. Click the **OK** Button to start printing.

Printing for an LCU/LCB Element

- 1, 2, 3... 1. Select the LCU/LCB element from the Project Workspace, and then select **Print** and **CSV Tag List** from the File Menu.
2. Click the **OK** Button. The CSV tag lists in the LCU/LCB element will start printing.

Printing for a Node (3 LCU Elements and 1 LCB□□ Element)

- 1, 2, 3... 1. Select the active function block file from the Project Workspace, and then select **Print** and **CSV Tag List** from the File Menu.
2. Click the **OK** Button. The CSV tag lists in active function block file will start printing.

3-11-8 Printing All

Printing All Data (Function Blocks, Block Diagrams, Ladder Diagrams, Cross-References, and Monitor Tag Lists) for an LCU/LCB Element

- 1, 2, 3... 1. Select the LCU/LCB element from the Project Workspace, and then select **Print** and **All** from the File Menu.
2. You can also specify the start page. Select the **Show** and **Hide** Buttons on each page to show and hide specific pages.
3. Click the **OK** Button. All the data in the LCU/LCB element will start printing.

Printing All Data (Function Blocks, Block Diagrams, Ladder Diagrams, Cross-References, and Monitor Tag Lists) for a Node (3 LCU Elements and 1 LCB□□ Element)

- 1, 2, 3... 1. Select the active node block function block files from the Project Workspace, and then select **Print** and **All** from the File Menu.
2. You can also specify the start page. Select the **Show** and **Hide** Buttons on each page to show and hide specific pages.
3. Click the **OK** Button. All data in active function block file will start printing.

3-11-9 Printing ITEM Lists

Printing an Active (i.e., Currently Open) ITEM List

- 1, 2, 3... 1. Display the ITEM list.
2. Right-click the ITEM List Window, and then select **Print ITEM List** from the pop-up menu. The Print Dialog Box will be displayed.
3. Set the number of copies to be printed, and then click the **OK** Button to start printing.

3-11-10 Printing Sequence Tables

Printing an Open Sequence Table

- 1, 2, 3... 1. Display the sequence table.
2. Right-click on the sequence table and select **Print/General** or **Print/Separated** from the pop-up menu. The Print Dialog Box will be displayed.
 - The entire sequence table will be printed if Print/General is selected.
 - If the sequence table has been expanded, the expanded portion will be printed separately if Print/Separated is selected.

3. Set the number of copies to be printed, and then click the **OK** Button to start printing.

Printing the Sequence Tables for an LCU/LCB Element

- 1, 2, 3... 1. Select the LCU/LCB element on the Project Workspace and select **Print/Sequence Control** from the File Menu.
2. Select **All** to print all of the sequence tables for the LCU/LCB element. Select **Select Area** to specify the sequence tables to print, and then input the numbers for the first and last sequence tables to print. The numbers correspond to the order that the block diagrams were registered in. The starting page can also be specified.
3. Click the **OK** Button. The specified sequence tables will be printed.

Printing Sequence Tables for a Node (for up to 3 LCU Elements and 1 LCB□□ Element)

- 1, 2, 3... 1. Select an active node file in the function block navigator select **Print/Sequence Control** from the File Menu.
2. If desired, specify the starting page and select the display setting for each page.
3. Click the **OK** Button. The specified sequence tables in the active node file will be printed.

3-11-11 Printing User Link Tables

Printing an Open User Link Table

- 1, 2, 3... 1. Display the user link table.
2. Right-click on the user link table and select **Print** from the pop-up menu. The Print Dialog Box will be displayed.
3. Set the number of copies to be printed, and then click the **OK** Button to start printing.

Printing User Link Tables for a Node (for up to 3 LCU Elements and 1 LCB□□ Element)

- 1, 2, 3... 1. Select an active node file in the Project Workspace select **Print/User Link Table** from the File Menu.
2. Click the **OK** Button. The specified sequence tables in the active node file will be printed.

3-11-12 Printing Connection Maps

Printing an Open Connection Map

- 1, 2, 3... 1. Display the connection map.
2. Right-click on the connection map and select **Print** from the pop-up menu. The Print Dialog Box will be displayed.
3. Set the number of copies to be printed, and then click the **OK** Button to start printing.

Note To print the connection map for a function block selected in the Project Workspace, select **Print** from the File Menu.

3-12 Setting Options

3-12-1 Overview

Options can be set for the CX-Process Tool. Select **Options** from the Setting Menu. The following Product Information Settings Dialog Box will be displayed.

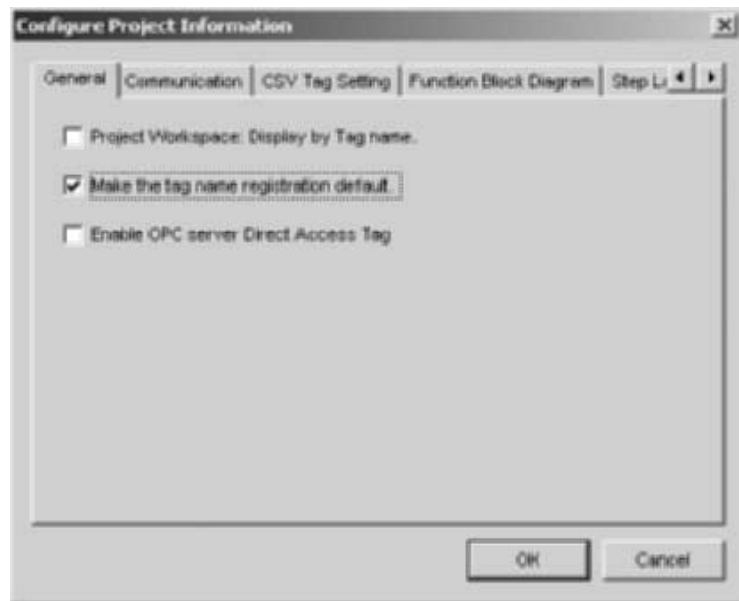

The settings made here apply to the entire Project Workspace (i.e., the entire project).

Option Settings

The following items can be set.

| Tab | Option | Meaning | Default |
|---------------|---|--|----------|
| General | Project Workspace: Display by Tag name. | When selected, displays CSV tag names for function blocks on the project tree. | Off |
| | Make the tag name registration default. | When selected, selects using tag names and tag ITEMS when setting ITEMS, such as when specifying the send source of function blocks. When not selected, selects inputting numerical values (BBBBIIII) are in sequence. | On |
| | Enable OPC server Direct Access Tag | When selected, adds ITEMS other than for HMI data to the tag file as OPC server direct access tag when outputting the tag file. | Off |
| Communication | Retry times | Set the number of retries for communications with the PLC. | 3 |
| | Time-out value | Sets the response timeout monitoring time (only when FinsGateway is the communications driver). | 5,000 ms |

| Tab | Option | Meaning | Default |
|------------------------|--|---|---------|
| CSV Tag Setting | Show extended property | When selected, outputs OPC Server scaling tags. Use this option to perform scaling using an OPC Server. | Off |
| | Always enable OPC Server scaling tag option | When selected, makes outputting OPC Server scaling tags the default setting. | Off |
| | Treat User Link Table as OPC Server scaling tag | When selected, outputs scaling tags for CSV tags in the user link table. OPC Server scaling tag output is also enabled for CSV tag entries in the user link table. | Off |
| | Assume data range of ITEM related to MV to be 0-100% | When selected, the limits for the data range of the three ITEMS MV, MH_LMT, and ML_LMT on the OPC Server are set to lower limit = 0.00% and upper limit = 100.00%. | Off |
| | Replace the first character of tag name with “_” | When selected, replaces the hash symbol (#) at the beginning of tag names in the CSV tag file with an underscore (_). | Off |
| Function Block Diagram | Scale | Set the display zoom for function block diagrams. | 100 |
| | Grid Mode | When selected, displays the grid. | Off |
| | Tag Display Mode | When selected, displays CSV tag names for function block names. | Off |
| | Color Function Block bitmap | When selected, displays function blocks pasted in the function block diagram in colors according to the type of function block. | Off |
| Step Ladder | Scale | Sets the display zoom for the ladder diagram. | 100 |
| | Data title display | When selected, displays information for the selected ITEM. | Off |
| Sequence Table | Scale | Sets the display zoom for the sequence table. | 100 |
| | Edit Mode enabled when window is opened. | When selected, edit mode is automatically entered when a sequence table is displayed. | Off |
| | Show Point Navigation. | When selected, displays intersections | On |
| | Show Vertical Line. | When selected, displays vertical lines. | Off |
| User Link Table | Register Tag Name automatically when connected to Field Terminal. | When selected, automatically registers tags in the user link table (with automatic tag naming) when software connections are made for field terminals. | On |
| | Set default to update refresh cycle of User Link Table automatically when LCU/LCB element is downloaded. | When selected, sets the refresh period for tags in user link tables to the same value as the processing period for the function block to which a software connection is made. | On |
| Connection Map | Scale | Sets the display zoom for the connection map. | 100 |
| | Always update the contents of connection map. | When selected, , refreshes connection map displays continuously. | On |

3-12-2 General Tab Page

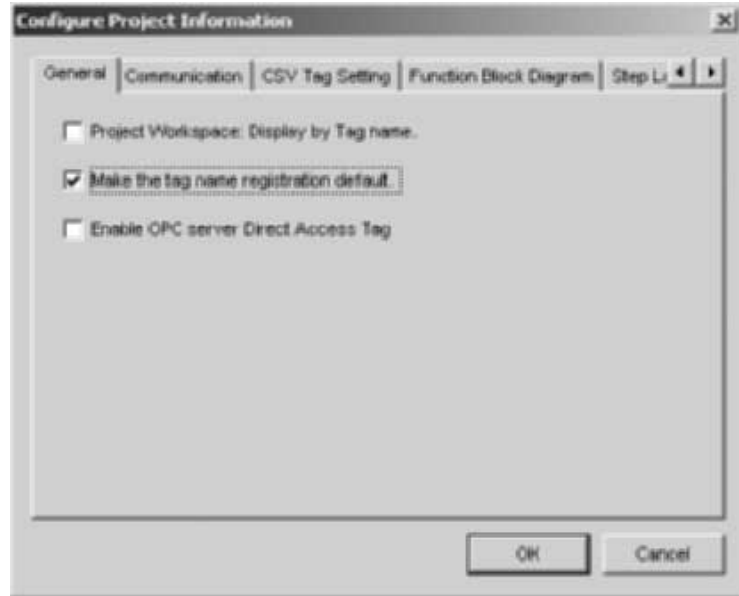

Project Workspace: Display by Tag name.

When this option is selected, CSV tag names will be displayed for function blocks on the project tree whenever CSV tag names have been set.

When this option is not selected (the default), function block names will be displayed for function blocks on the project tree as normal.

Make the tag name registration default.

When this option is selected (the default), ITEMS can be specified from pull-down lists of tag names and tag ITEM names for the following:

- For the source designation (connection data designation) for a function block
- When **Edit – Edit Connection** is selected after right-clicking an ITEM displayed in blue
- When editing signals in sequence tables
- When editing symbols in step ladder diagrams

The following example shows designating the source (i.e., the connection data) for a function block.

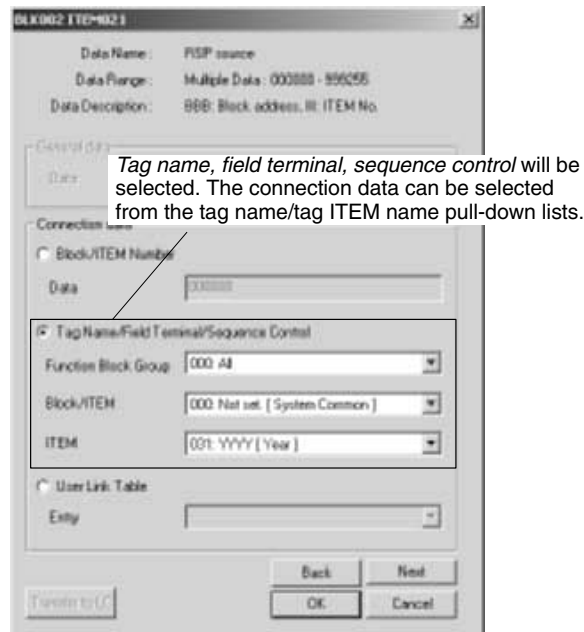

When this option is not selected, ITEMS are specified by inputting the block address followed by the ITEM number as a continuous series of numbers (BBBBIII) for the following.

- For the source designation (connection data designation) for a function block
- When **Edit – Edit Connection** is selected after right-clicking an ITEM displayed in blue
- When editing signals in sequence tables
- When editing symbols in step ladder diagrams

The following example shows designating the source (i.e., the connection data) for a function block.

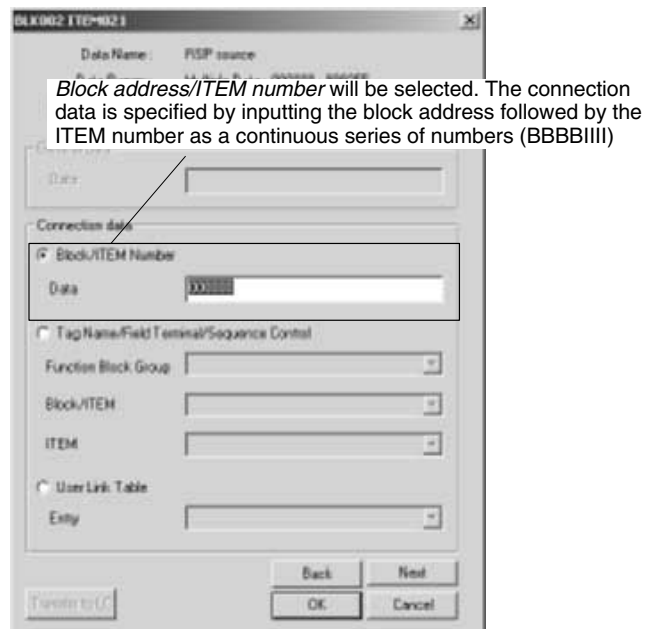

Enable OPC Server Direct Access Tag

When this option is selected, ITEMS other than for HMI data will be added to the tag file as OPC server direct access tags when outputting the tag file. This applies to Ramp Program (Block Model 155), Segment Program (Block Model 156), and Segment Program 2 (Block Model 157) only. This option is selected when the HMI area is not used and all of the ITEMS for these blocks are to be monitored and set directly from the SYSMAC OPC Server.

Function Blocks That Can Be Directly Accessed from the OPC Server

- Ramp Program (Block Model 155)
- Segment Program (Block Model 156)
- Segment Program 2 (Block Model 157)

3-12-3 Communication Tab Page

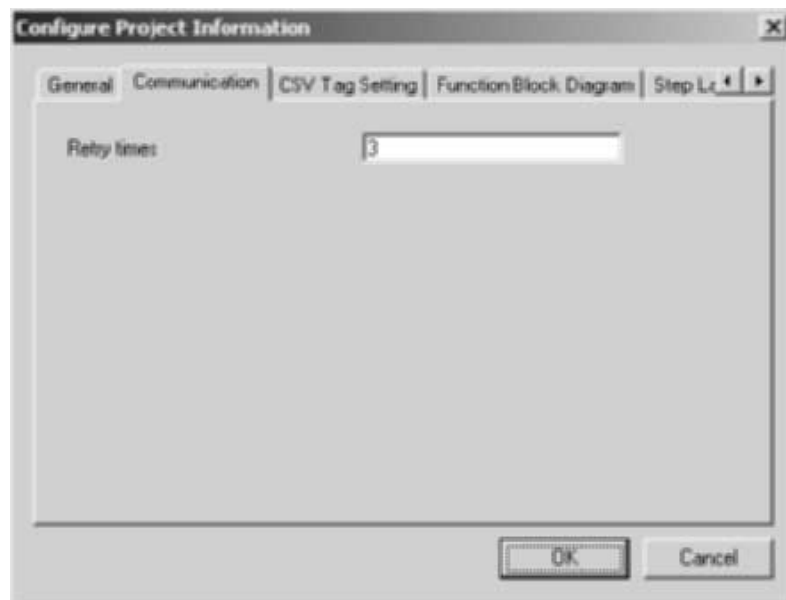
**Retry times**

This option sets the number of retries for communications with the Loop Controller. The default is 3 retries. Increase this number if there are communications timeouts.

Time-out value

This option sets the timeout time for communications with the Loop Controller. The default is 5,000 ms. If a heavy communications load causes timeouts, increase this time. The maximum time is 60,000 ms.

3-12-4 CSV Tag Setting Tab Page

Use this tab page to make the settings for exporting expanded scaling data for SYSMAC OPC Server version 2.6. Using expanded scaling data enables scaling in engineering units using a OPC Server. When this is done, scaling settings in the SCADA software are not required. For details, refer to *Expanded Scaling*

Data for SYSMAC OPC Server Version 2.6 (CX-Process Tool Version 4.0 or Higher Only) on page 142.



Show extended property

Select this option to output OPC engineering tags. This function enables scaling to be performed using the OPC Server.

Always enable OPC Server scaling tag option

Select this option to make outputting OPC engineering tags the default setting.

Treat User Link Table as OPC Server scaling tag

Select this option to output engineering tags for the CSV tags in the user link table. When this option is selected, OPC server engineering tags can also be output to CSV tag entries in the user link table.

Assume Data Range of ITEM Related to MV to Be 0-100%

Select this option to set the data range's lower limit to 0.00% and upper limit to 100.00% for the three items MV (MV output value or manual MV during MAN mode), MH_LMT (high MV limit), ML_LMT (low MV limit) in the OPC Server.

Replace the first character of tag name with “_”

Select this option to replace the hash symbol (#) at the beginning of tag names in the CSV tag file with an underscore (_). Tags cannot be imported to some SCA-DA software if a hash symbol is used as the first character of the tag names. The hash symbol can be changed to an underscore to enable importing.

3-12-5 Function Block Diagram Tab Page

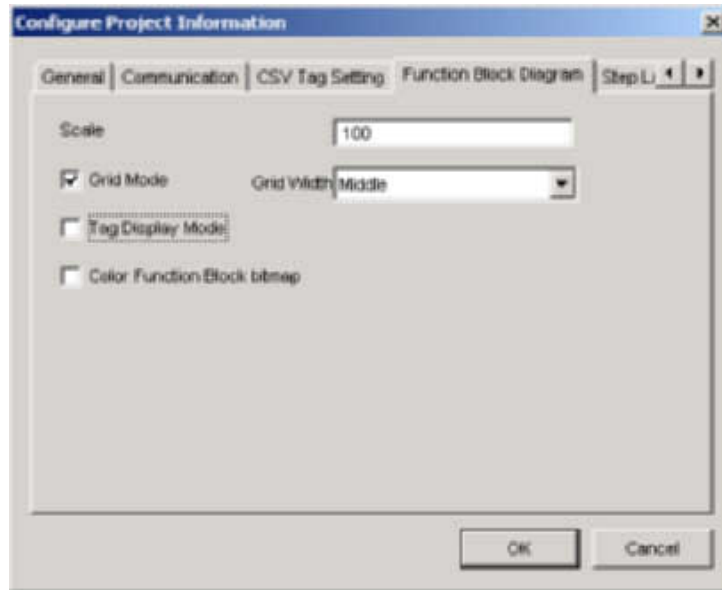

Scale

This option sets the zoom factor for block diagrams. (This option performs the same function as the Scale Menu in Edit Block Diagram Mode.)

100 (default): The normal display size

50: Half of the default size

200: Twice the default size

Grid Mode

- Newly Generated Projects in LCB□□ Ver. 3.0 or later

To display the grid, select the checkbox and set the grid width. The default grid width setting is enabled and *Narrow*. Grids can be displayed on block diagrams and lines can be created at the spacing for the selected grid and moved.

- Newly Generated Project Other Than the Above

Select the checkbox (default: cleared) and select the grid width from *Wide*, *Middle*, and *Narrow*. Grids can be displayed on block diagrams and lines can be created at the spacing for the selected grid and moved.

In either case, the function will be the same as selecting **Grid Mode** from the Display Mode Menu for the block diagram display mode.

Tag Display Mode

When this option is selected, CSV tag names are displayed for the function block names of function blocks pasted on the block diagram. This option is not selected by default. (This option performs the same function as the **Show CSV Tag Name** command on the Change Mode Menu in Edit Block Diagram Mode.)

Color Function Block bitmap

When this option is selected, function blocks pasted in the function block diagram are displayed in colors according to the type of function block. When this option is not selected, all function blocks are displayed in gray. This option is not selected by default.

- Adjustment blocks: Green
- Operation blocks: Light brown
- Field terminals: Pink
- User-defined blocks: Blue
- Other: Gray

Note The setting will not apply to any function block diagrams that are open when the setting is changed. Close the function block diagram window and then reopen it to see the results of changing this option.

3-12-6 Step Ladder Tab Page

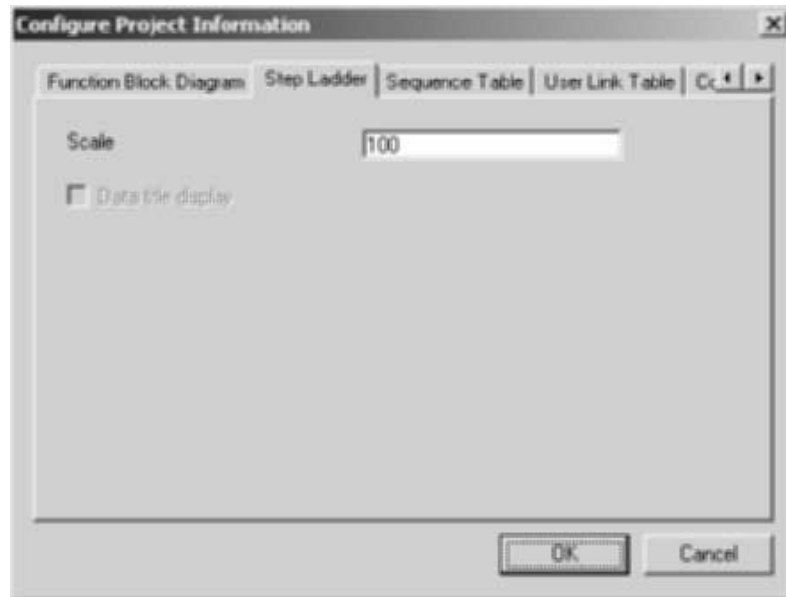

Scale

This option sets the zoom factor for ladder diagrams. (This option performs the same function as the Scale Menu in Ladder Diagram Mode.)

100 (default): The normal display size

50: Half of the default size

200: Twice the default size

Data title display

When this option is selected, information is displayed on selected ITEMS. This option is not selected by default. (This option performs the same function as ***Data title display*** on the Change Mode Menu in Ladder Diagram Mode.)

3-12-7 Sequence Table Tab Page

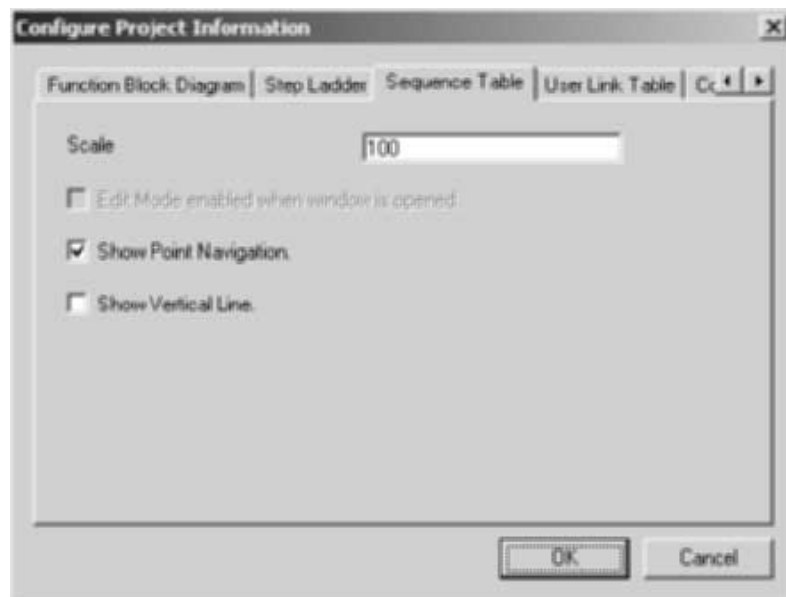

Scale

This option sets the zoom factor for sequence tables. (This option performs the same function as the Scale Menu in Sequence Table Mode.)

100 (default): The normal display size

50: Half of the default size

200: Twice the default size

Edit Mode enabled when window is opened.

When this option is selected (the default), edit mode is automatically entered when a sequence table is displayed.

When this option is not selected, edit mode is not entered when a sequence table is displayed. (To enter edit mode, **Edit Mode – Enable** must be selected from the pop-up menu that appears after right-clicking on the sequence table.)

Show Point Navigation

When this option is selected, intersection points are displayed. This option is selected by default. (This option performs the same function as **Point Navigation – Enable** on the Operation Menu.)

Show Vertical Line

When this option is selected, vertical lines are displayed. This option is not selected by default. (This option performs the same function as **Vertical Line – Show** on the Operation Menu.)

3-12-8 User Link Tab Page

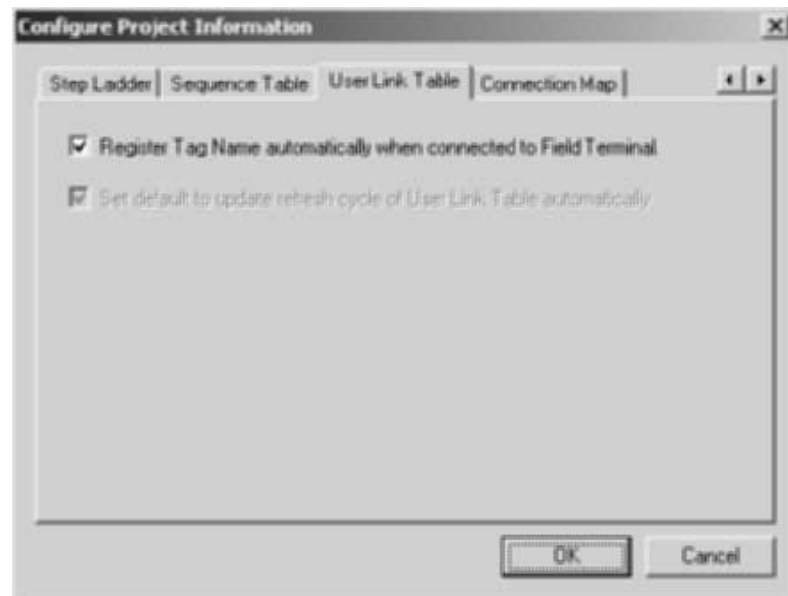
**Register Tag Name automatically when connected to Field Terminal.**

When this option is selected, tags are automatically registered in the user link table (with automatic tag naming) when software connections are made for field terminals. This option is selected by default.

Set default to update refresh cycle of User Link Table automatically.

When this option is selected (the default), the refresh period for tags in user link tables is set to the same value as the processing period for the function block to which a software connection is made.

When this option is not selected, the refresh period specified for tags in user link tables is used.

(This option performs the same function as the *Update user link table refresh cycle* option in the LCB Download Dialog Box display when downloading Loop Controllers.)

3-12-9 Connection Map Tab Page

Note The connection map is displayed by selecting **Connection Map** from the Execute Menu.

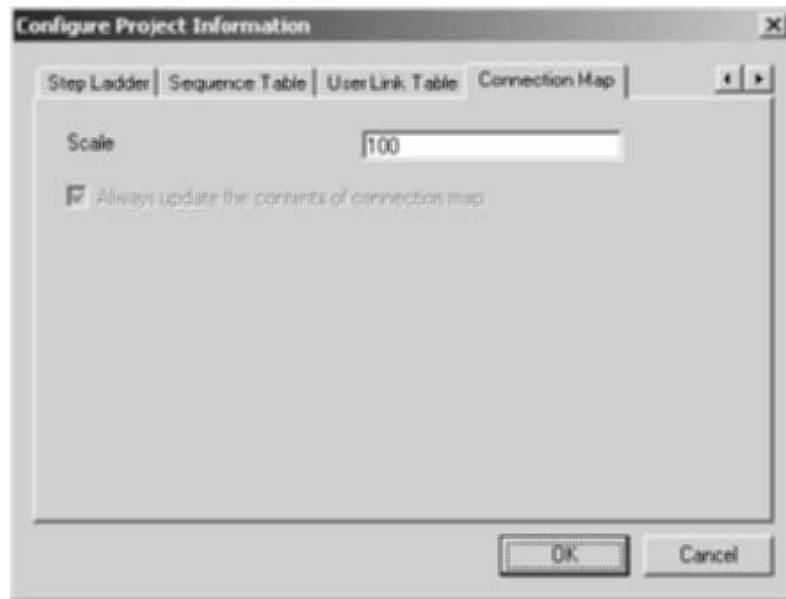

Scale

This option sets the zoom factor for the connection map. (This option performs the same function as the **Change Scale** command on the pop-up menu display after right-clicking on the connection map.)

Always update the contents of connection map.

When this option is selected (the default), the connection map is continuously refreshed.

When this option is not selected, the connection map is not continuously refreshed.

SECTION 4

Online Operation

This section describes online operations for uploading, downloading, and testing function block data.

| | | |
|--------|--|-----|
| 4-1 | Overview of Online Functions | 236 |
| 4-2 | Initial Settings for Online Connections | 238 |
| 4-2-1 | Selecting the Communications Driver | 238 |
| 4-2-2 | Using FinsGateway | 239 |
| 4-2-3 | Using CX-Server | 248 |
| 4-2-4 | Peripheral Bus (Toolbus) Connections | 249 |
| 4-3 | Downloading, Uploading and Comparing Data | 251 |
| 4-3-1 | Downloading (Transfer to LC) | 252 |
| 4-3-2 | Uploading (Transfer from LC) | 257 |
| 4-3-3 | Compare | 260 |
| 4-4 | Run/Stop Command | 264 |
| 4-5 | Monitor Run Status | 266 |
| 4-5-1 | Monitoring the System Run Status | 266 |
| 4-5-2 | ITEMs Marked “Reset” | 267 |
| 4-5-3 | ITEMs Marked “Detailed display” | 267 |
| 4-5-4 | Checking Versions | 269 |
| 4-6 | Operation Check | 270 |
| 4-6-1 | Monitoring ITEM Data for Selected Function Blocks | 271 |
| 4-6-2 | Downloading Individual ITEM Data Settings | 271 |
| 4-6-3 | Block Diagram Check | 271 |
| 4-6-4 | Wireless Debugging (LCB□□ Ver. 3.0 or Later Only) | 275 |
| 4-6-5 | Forced Changes to Analog Output Signals | 276 |
| 4-6-6 | Ladder Diagram Operation Check | 278 |
| 4-6-7 | Validating Sequence Table Operation (LCB05/05D Only) | 281 |
| 4-7 | Tuning | 294 |
| 4-7-1 | Switching to the Tuning Screen | 294 |
| 4-7-2 | Data Logging on Tuning Screens | 295 |
| 4-7-3 | Screen Configuration | 297 |
| 4-7-4 | Face Plate Controls | 298 |
| 4-7-5 | Operation Procedures | 302 |
| 4-8 | Backup and Recovery | 306 |
| 4-8-1 | Backup Procedure | 306 |
| 4-8-2 | Recovery Procedure | 307 |
| 4-9 | Transferring Tag and Comment Data | 309 |
| 4-9-1 | Backing Up Data to the Memory Card | 309 |
| 4-9-2 | Recovering Data from the Memory Card | 311 |
| 4-10 | Clear All | 313 |
| 4-11 | Controlling the CPU Unit | 314 |
| 4-11-1 | Creating the I/O Tables | 314 |
| 4-11-2 | Setting the PLC Setup | 314 |
| 4-11-3 | Changing the Operating Mode of the CPU Unit | 314 |
| 4-12 | Password Protection | 315 |
| 4-12-1 | Online Operations for Loop Controller | 315 |
| 4-12-2 | Inputting the Password before Uploading Data | 316 |

4-1 Overview of Online Functions

The CX-Process Tool has the following online functions.

| Function | Description | | Menu commands |
|--------------------------|---|---|--|
| Download/Upload | Downloads, uploads, or compares function block files (.ist) to RAM in the Loop Controller. Note The comparison of two function block files including mnemonics is possible. | | Execute/Download, Upload New, Upload Previous, and Compare |
| Download Individual ITEM | Individual ITEM data can be downloaded from the ITEM's Settings Dialog Box. | | Click the Download Button after setting a value in the function block ITEM's Settings Dialog Box. Alternatively, display the ITEM's Settings Dialog Box from the ITEM List, set the desired value, and click the Download Button. |
| Run/Stop command | Runs or stops the Loop Controller. | | Execute/Operation, and Run/Stop |
| Monitor run status | Sets and monitors the System Common Block (block model 000) of a Loop Controller. | | Execute/Operation, and Monitor Run Status |
| Validate action | Debugs the function block data in RAM of a Loop Controller. | | |
| | 1) Monitors all ITEM data in specified function blocks. | Reading and displaying all f the ITEM data in function blocks (except Step Ladder Program). | Select Monitor/ITEM List from the pop-up menu or Execution menu. |
| | 2) Checks the operation of function block connections for a Loop Controller. (Block Diagram Validate Action Mode) | The following can be performed for function blocks (excluding step ladder programs): Displaying analog output signal values Forcibly changing analog output signals Independently stopping block operation or canceling the stop block operation command for a function block. Pseudo-inputting present values (<i>Wireless Debug</i> Setting – Calibration Mode) | Select Start from the Validate Action Menu with the block diagram displayed. Double-click each function block and operate in the Execute Dialog Box. |
| | 3) Checks the operation of the ladder diagram in the Loop Controller. (Ladder Diagram Validate Action Mode) | The following can be performed for a step ladder program (block model 301): Displaying the status of contact ITEMS. Contact ITEM force-setting/resetting Independently stopping block operation or canceling the stop block operation command for a function block incorporating contact ITEMS. Note It is possible to force-set or force-reset the contact ITEMS of registered function blocks. | Select Start from the Validate Action Menu with the ladder diagram displayed. Double-click the command symbol and operate in the Execute Dialog Box. |
| | 4) Validates the operation of a sequence table (Sequence Table Validate Action Mode) | The following can be checked in a sequence table (block model 302): Current step number Rule conditions (met/not met) Condition signal conditions (met/not met) Action signal conditions (met/not met) | Select Start from the Validate Action Menu with the sequence table displayed. |

| Function | Description | Menu commands |
|-----------------|--|---|
| Tuning | Settings such as the function block's PID constants can be adjusted. | Select Monitor/Tuning Screen from the Execution Menu. |
| Backup/Recovery | Copies function block data from RAM to flash memory in the Loop Controller or restores the data back to RAM. | Select Backup Data operation from the Execute Menu. |
| Clear all | Initializes the function block data in the Loop Controller. | Select Operation and Clear all from the Execution Menu. |

4-2 Initial Settings for Online Connections

The following initial settings are required in order to connect the CX-Process Tool to the PLC online and enable the online functions described above.

Select one of the following communications drivers for the online connection with the PLC (Programmable Controller):

- FinsGateway
- CX-Server

4-2-1 Selecting the Communications Driver

The following dialog box is displayed when the CX-Process Tool is started from the Windows Start Menu or when **Start Only** is selected from the I/O tables.

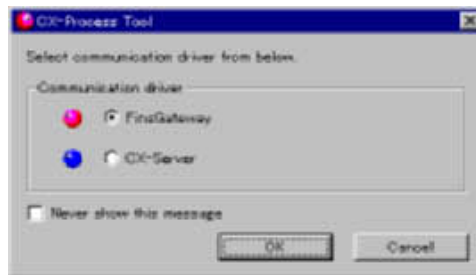

Using FinsGateway

Select **FinsGateway** as the communications driver.

Using CX-Server

Select **CX-Server** as the communications driver.

- Note**
1. The above dialog box will be displayed when the CX-Process Tool is started while **File – Show Drive Select Dialog – Display** is selected. It will not be displayed if **File – Show Drive Select Dialog – Hide** is selected. To change the communications driver, select **File – Show Drive Select Dialog – Display** and then start the CX-Process by selecting **Start Only** from the Start Menu or I/O tables. If the CX-Process was installed as part of the CX-One (not independently), the above dialog box will not be displayed (i.e., **File – Show Drive Select Dialog – Hide** will be selected) and the CX-Server will automatically be used as the communications driver. To switch to the FinsGateway, select **File – Show Drive Select Dialog – Display** and then select **FinsGateway** at startup.
 2. Projects created with CX-Server selected as the communications driver are not completely compatible with projects created with FinsGateway selected as the communications driver. The following points are incompatible between the projects created with different communications drivers:
 - When CX-Server is selected as the communications driver and the computer is connected directly to the PLC (node address set to 0), it won't be possible to select FinsGateway and open the project later because FinsGateway must have a node address setting of 1 or higher. It is possible to open the project and use FinsGateway if the node address is changed. Select CX-Server, open the project, change the node address to 1 or higher (file name other than "Node00"), and save the project again. Select FinsGateway and open the project.
 - When a project has been created with FinsGateway selected as the communications driver and that project is later opened with CX-Server selected as the communications driver, the network address will be set to 0 automatically. After opening the project, reset the network address setting in each node's function block file.

4-2-2 Using FinsGateway

Serial Connections

Initial Settings

- 1, 2, 3...
1. Set the unit numbers of the Loop Control Units (with the rotary switches on the front panels) (Loop Control Units only).
 2. Set the I/O tables.

Note The creation of the I/O tables with the version 6.1 or higher of the CX-Programmer is restricted as follows:

- The Loop Control Unit will not be recognized. Instead, a message saying that the type of the Unit is unknown will appear after mounting the Unit/Board, creating the I/O table online, and reading the registered I/O table on the I/O table window (using **From PLC**).
 - The Loop Control Unit cannot be set in the I/O table by editing the I/O table offline.
3. Set the CPU Unit's serial communications mode (in PLC Setup settings).
 4. Set the DIP switch on the front panel of the CPU Unit, or for a CS1D Duplex System, on the front panel of the Duplex Unit.
 - To use the peripheral port, turn ON pin 4 or the PRPHL pin and set PLC Setup Programming Console address 144 to 0000 HEX.
 - To use the RS-232C port, set pin 5 or the COMM pin to OFF and set PLC Setup Programming Console address 160 to 0000 HEX (i.e., the default value).

Initial Settings in CX-Process Tool

After the above steps, take the following steps in the CX-Process Tool.

- Set the network address to any value between 000 and 127 for direct serial connections and set the node address to 01.
- Set the unit address (input in decimal the unit number of the Loop Control Unit plus 10 Hex) (Loop Control Units only).
- Select **Activate Serial Port Driver** from the File Menu, set the COM port and communications speed, and click the **OK** Button.

If any of the above settings is incorrect, the CX-Process Tool will not connect to the Loop Controller.

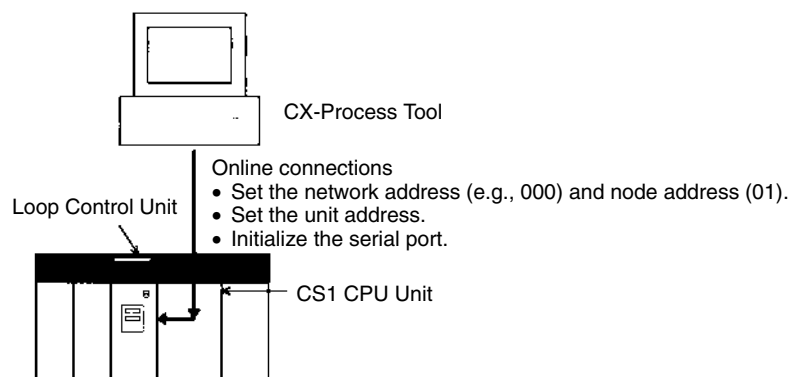

Setting Network and Node Addresses

- 1, 2, 3... 1. Select the active function block file in the Project Workspace first. Select **Network Settings** from the Settings Menu. The following dialog box will appear.



2. Click the **OK** Button. The following dialog box will appear.



3. Set the network address (to any value between 000 and 127) in the Network Address Field and set node address 01 in the Node Address Field. Do not set the node address to a different value if the serial connection is used, otherwise no communications will be possible.
4. Click the **OK** Button.

Note The COM1 and COM2 ports of the personal computer must have different network addresses. The COM1 and COM2 ports will be specified during serial initialization, explained later. If there is any duplication of network addresses, serial communications will not be possible.

Setting Unit Addresses (Loop Control Units only)

- 1, 2, 3... 1. After the above settings, select the LCU element (LC001-1 to LC001-3) and select **Network Settings** from the Settings Menu. The following dialog box will appear with the network address and node address already set.

- Note**
- a) If the network address or node address has not been set, a different dialog box will appear and prompt the user to input them. After the addresses are input, the dialog box for unit address setting will appear.
 - b) The unit address can be set with the LCU element selected but not with the Project Workspace selected.



2. Input the unit address between 16 and 31 in decimal into the unit address field. The unit address to be input is between 16 and 31 (10 and 1F Hex). In

other words, add 16 (10 Hex) to the unit number between 0 and 15 (0 to F Hex) set with the rotary switch on the front panel of the Loop Control Unit as a CPU Bus Unit.

If the value is incorrect, the personal computer will not connect to the Loop Control Unit.

Note In the CX-Process, input the unit address in decimal (between 16 and 31).

3. Click the **OK** Button.

Note It is necessary to set the unit address for the serial connection as well. If the wrong unit address is set, a dialog box will appear with a message during data downloading with error code 0401 or 0202.

- Note**
1. When the network address, node address, and unit address are set, these addresses will appear in order on the right of the LCU element in the Project Workspace.

Example

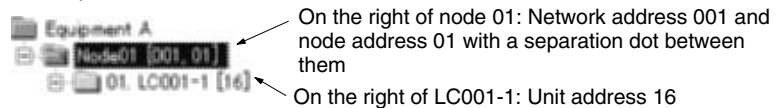

2. In addition to manually setting the addresses, as described above, they can also be set automatically by searching for Loop Controllers connected to networks of the PLC connected to the CX-Process Tool. Select the LCU element and then select **Find LCU/LCB** from the File Menu. This can be performed even before initializing serial communications. Refer to *Automatically Setting Addresses* (page 245) for details.

Initializing Serial Communications

If a serial connection is used, it is possible to start FinsGateway Communications service with the following steps.

- 1, 2, 3... 1. Select **Activate Serial Port Driver** from the File Menu. The following dialog box will appear.



2. Input the name of the COM port of the personal computer and the baud rate. The baud rate can be set to 9600, 19200, 38400, 57600, or 115200 bps but it must be the same as that set in the CPU Unit in serial communications mode, otherwise no communications will be possible.

Note Set the data length to seven bits, the number of stop bits to two, and the parity to even as communications conditions.

3. Click the **OK** Button.
4. The following dialog box will appear.

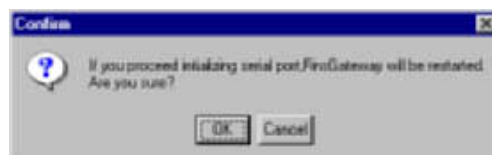

5. Click the **OK** Button. Serial communications will be initiated.

- Note** 1. The following dialog box will appear is an online function, such as downloading or uploading data, is attempted before the initialization of serial communications has been finished. The dialog box will include a message stating an error occurrence at the stage of initialization with error code 0503.



2. If another Support Software application communicating over the CX-Server, such as the CX-Programmer, CX-Protocol, or CX-Motion, or an application using the dedicated serial driver is connected online, the CX-Process Tool cannot be connected to the same COM port online via Host Link. (The initialization of serial communications is possible but actual online connections will not be possible.) Disconnect any other applications, then reconnect the CX-Process Tool by initializing serial communications. (If the CX-Process Tool is connected or initializing serial communications using FinsGateway as the driver, no software applications communicating over the CX-Server can be connected to the same COM port.)
3. When serial communications are initialized, the FinsGateway communications service will start. If another FinsGateway application is running, the FINS communications of the application may be affected by the initialization of serial communications.
4. With Windows NT4.0, serial communications cannot be initialized unless the user is the administrator.
5. Initializing serial communications will start the SYSWAY-CV communications for the FinsGateway. With this method, a FINS commands are sent wrapped in a Host Link header and terminator. Before operating the FinsGateway Version 3 Serial Unit, select SYSWAY-CV as the protocol.

Controller Link

Initial Settings

- 1, 2, 3...**
1. Set the unit numbers of the Loop Control Units (with the thumbwheel switches on the front panels) (Loop Control Units only).
 2. Set the I/O tables.
 3. Make switch settings on the Controller Link Support Board and mount the Controller Link Support Board to the personal computer.
 4. Connect the cable between the Controller Link Support Board and Controller Link Unit.

Note Refer to the *Controller Link Support Board Operation Manual* for details.

Initial Settings in CX-Process Tool

Setting Network and Node Addresses

Select the active function block file in the Project Workspace and select **Network Settings** from the Settings Menu. The following dialog box will appear.



- 1, 2, 3...**
1. Set the network address to between 000 and 127 in the Network Address Field and set the node address to between 1 and 32 in the Node Address Field.
 2. Click the **OK** Button.

Note Set the network address to 0 if the local network is connected to the Controller Link.

Note If Controller Link is used, manually set the above network address and node address using the FinsGateway manual setting. If the manual settings are not made or different addresses are set, no online connections will be possible.

Setting Unit Addresses (Loop Control Units Only)

After the above settings, select the LCU element (LC001-1 to LC001-3) and select **Network Settings** from the Settings Menu. The following dialog box will appear with the network address and node address already set.



- 1, 2, 3...**
1. Input the unit address between 16 and 31 into the Unit Address Field. The unit address is between 16 and 31 (10 and 1F Hex). In other words, add 16 (10 Hex) to the unit number between 0 and 15 (0 to F Hex) set on the rotary switches on the front panel of the Loop Control Unit as a CPU Bus Unit.
 2. Click the **OK** Button.

Note In addition to manually setting the addresses, as described above, they can also be set automatically by searching for Loop Controllers connected to networks of the PLC connected to the CX-Process Tool. Select the LCU element and then select **Find LCU/LCB** from the File Menu. This can be performed even before initializing serial communications. Refer to *Automatically Setting Addresses* (page 245) for details.

Starting Communications Service

If the Controller Link is used, it is necessary to start the FinsGateway communications service manually. Select **FinsGateway Settings** from the FinsGateway Menu.

Ethernet Initial Settings

- 1, 2, 3...**
1. Set the unit numbers of the Loop Control Units (with the rotary switches on the front panels) (Loop Control Units only).
 2. Set the I/O tables.

3. Set the IP address and subnet mask.
4. Connect the cable between the Ethernet connector and Ethernet Unit (see note).

Note Refer to the *Ethernet Unit Operation Manuals* (W420, W421) for details.

CX-Process Initial Settings

Setting Network and Node Addresses

Select the active function block file in the Project Workspace and select **Network Settings** from the Settings Menu. The following dialog box will appear.



- 1, 2, 3... 1. Set the network address to between 000 and 127 in the Network Address Field and set the node address to between 1 and 32 in the Node Address Field.
2. Click the **OK** Button.

Note Set the network address to 0 if the local network is connected to Ethernet.

Note If Ethernet is used, manually set the above network address and node address using the FinsGateway manual setting. If the manual settings are not made or different addresses are set, no online connections will be possible.

Unit Addresses (Loop Control Units Only)

After the above settings, select the LCU element (LC001-1 to LC001-3) and select **Network Settings** from the Settings Menu. The following dialog box will appear with the network address and node address already set.



- 1, 2, 3... 1. Input the unit address between 16 and 31 in decimal into the Unit Address Field. The unit address to be input is between 16 and 31 (10 and 1F Hex). In other words, add 16 (10 Hex) to the unit number between 0 and 15 (0 to F Hex) set with the rotary switches on the front panel of the Loop Control Unit as a CPU Bus Unit.
2. Click the **OK** Button.

Note In addition to manually setting the addresses, as described above, they can also be set automatically by searching for Loop Controllers connected to networks of the PLC connected to the CX-Process Tool. Select the LCU element and then select **Find LCU/LCB** from the File Menu. This can be performed even before initializing serial communications. Refer to *Automatically Setting Addresses* (see below) for details.

**Starting Up
Communications Service**

If Ethernet is used, it is necessary to start up the FinsGateway communications service manually. Select **FinsGateway Settings** from the FinsGateway Menu.

Automatically Setting Addresses

In addition to manually setting the network, node, and unit addresses, they can also be set automatically by searching for Loop Control Units connected to networks of the PLC connected to the CX-Process Tool.

Use the following procedure to automatically set the addresses.

- 1, 2, 3...** 1. Select the LCU element and then select **Find LCU** from the File Menu.

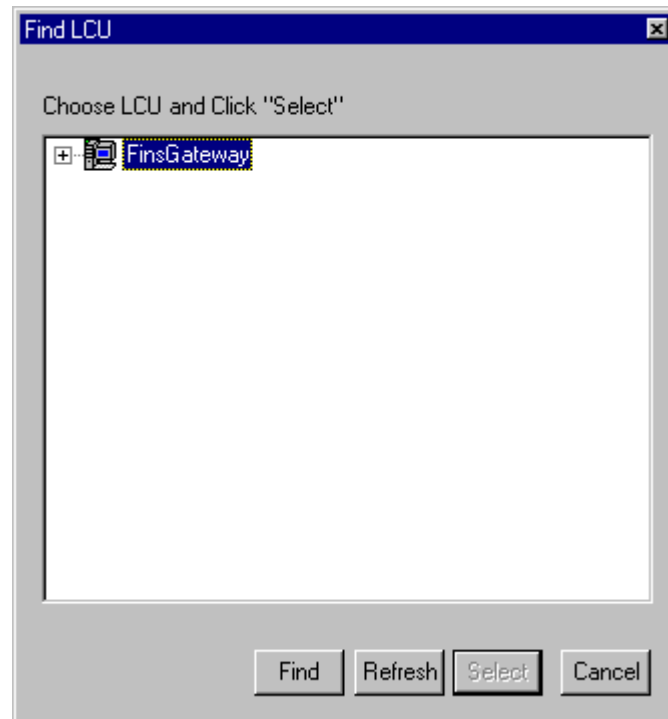

- Click the **Find** Button. The Loop Control Units on networks of the PLC to which the CX-Process is connected will be found and the cursor will move to the Loop Control Unit that was found.

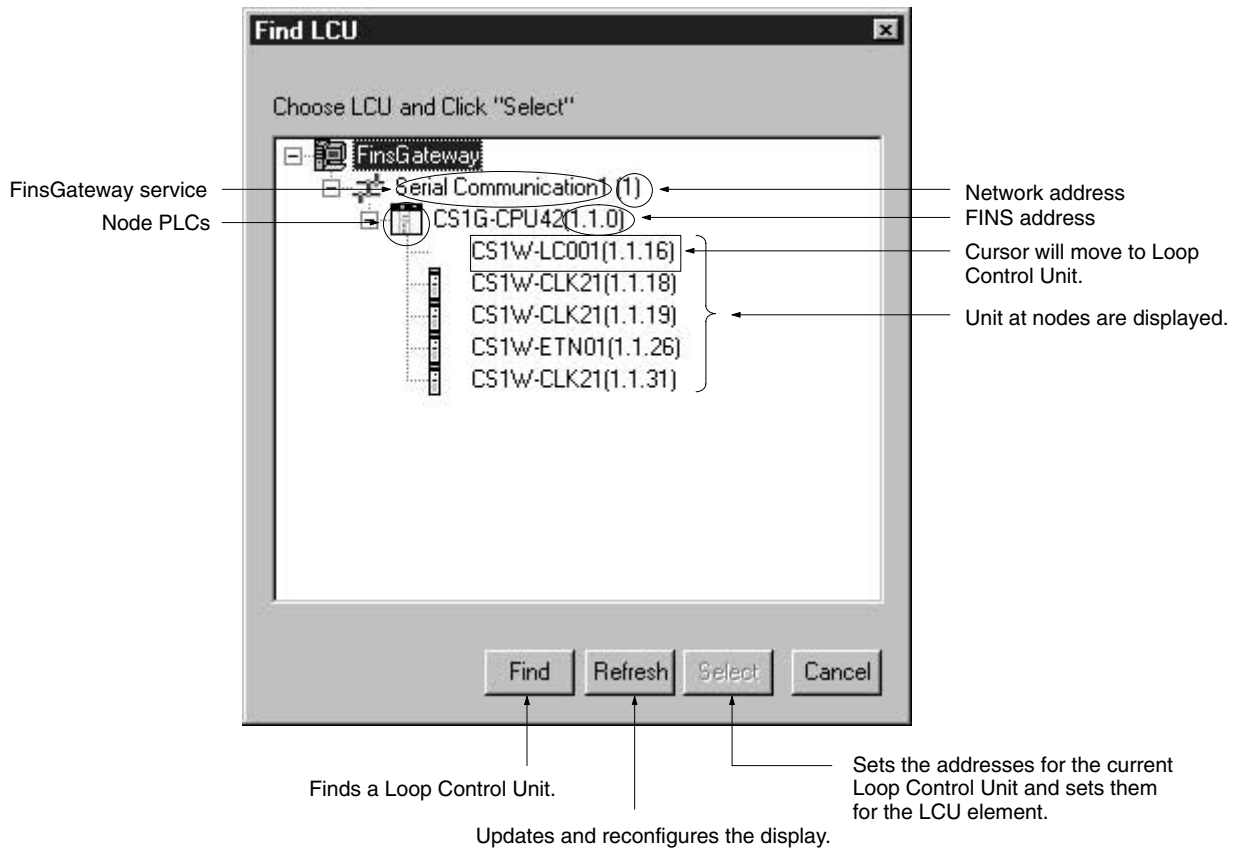

- Keep on pressing the **Find** Button to find the next Loop Control Unit.

Note Although it is possible to search for a Loop Control Board as well, the unit address is always 255 and thus Loop Control Boards are not supported by this function.
- To register the addresses of a selected Loop Control Unit, click the **Select** Button. The addresses will automatically be set for the LCU element.

Direct FinsGateway Online Connections

To make initial settings for direct FinsGateway online connections, take the following steps. Refer to the *FinsGateway Operation Manual* for details.

- 1, 2, 3...** 1. Serial Settings

Make necessary settings, such as personal computer communications port, node address, and protocol (serial communications mode) settings.

Select **FinsGateway Settings** from the FinsGateway Menu. The following dialog box will appear.

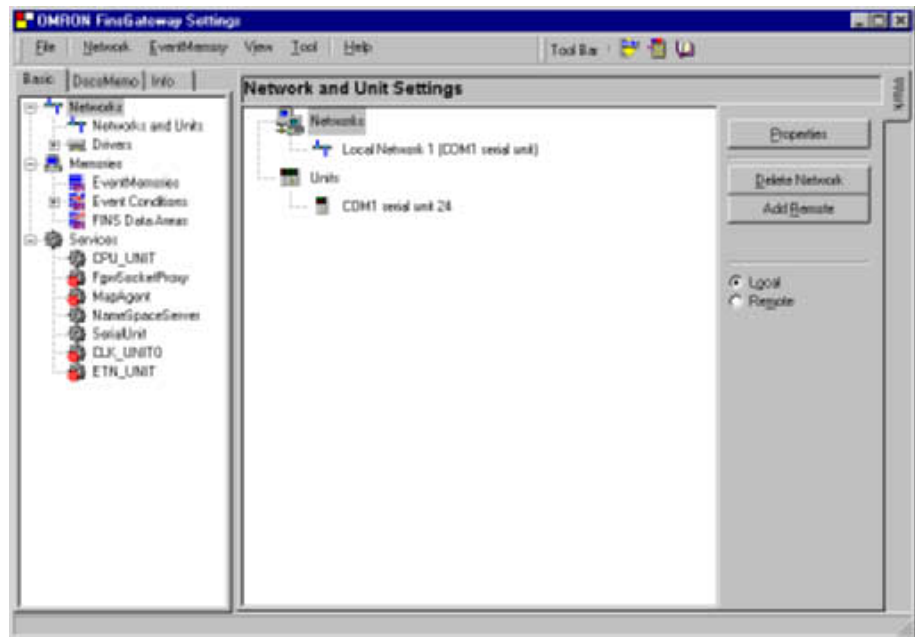

Select **Network/Driver** from the directory tree on the left side of the window and double-click **SerialUnit** in the compatible drivers listed on the right side of the window. Click the **Node** Tab to display the following dialog box.

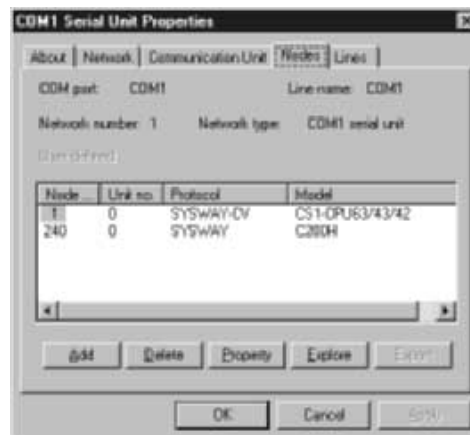

After serial initialization, the node number will be set to 1 (actually 01) and the protocol will be set to SYSWAY CV. To modify the settings, click the **Properties** Button.

2. FinsGateway Settings

The FinsGateway Settings start and stop communications service.

If the Controller Link or Ethernet is being used, start the FinsGateway communications service from the FinsGateway Settings.

Select **FinsGateway Settings** from the FinsGateway Menu and select **SerialUnit** from the **Services** directory tree on the left side of the window.

Click the **Start** Button on the right side of the window to perform the same operations that are performed in serial initialization. The Serial Unit will start (CPU_UNIT is always started) as shown in the following diagram.

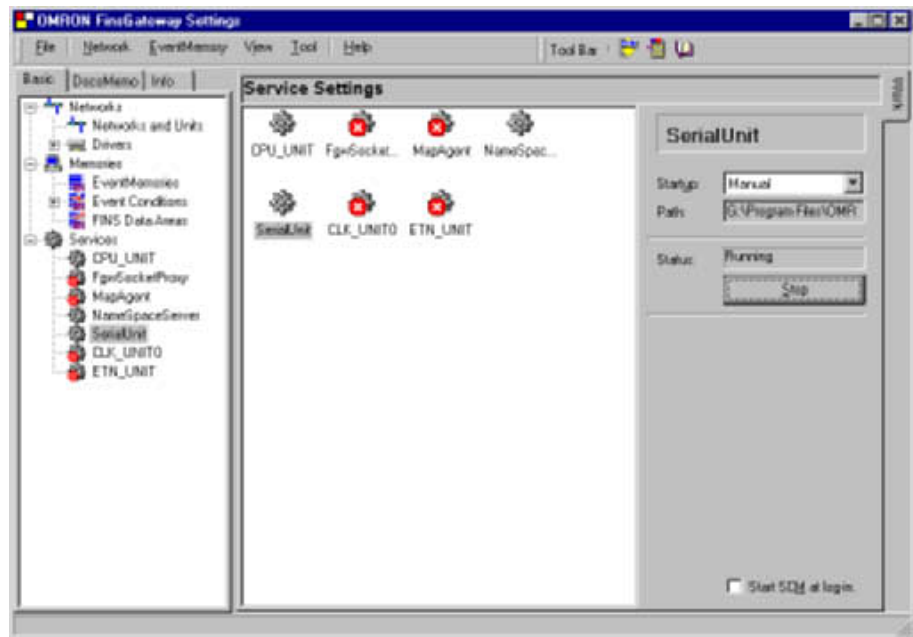

The FinsGateway Settings Window can be used to check whether or not on-line communications were properly established by the serial initialization operations.

4-2-3 Using CX-Server

When CX-Server is selected as the communications driver and the initial settings described below have been made, the online connection is established automatically when online operations such as downloading are executed. (There is no need for operations like the FinsGateway “serial initialization” operations.)

Serial Connections

Initial Settings

The unit number setting procedure is the same as the procedure for the FinsGateway.

Initial Settings in CX-Process Tool

1, 2, 3...

After setting the unit number, take the following steps in the CX-Process Tool.

1. Select **Change PLC** from the Settings Menu.
2. The Change PLC Dialog Box will be displayed.



Select **SYSMAC WAY** (Host Link) as the network type.

- If necessary, the Network Settings Dialog Box can be displayed by clicking the **Settings (S)** Button next to the network type.

The port name (COM port number) can be selected in the Driver Tab. Also, the baud rate and data format can be set to match those of the connected PLC.

When the computer is being connected directly to the PLC, leave the node address set to 0 (the default setting) in the Network Tab. (It will not be possible to open this project later with FinsGateway selected as the communications driver without changing the node address to a non-zero setting.)

Note When CX-Server has been selected as the communications driver, set the node address to a non-zero value in the Network Settings Dialog Box before compiling the Monitor tag file or CSV tag file. Select **Change PLC** from the Settings Menu to display the dialog box. (If the computer is connected online, return the node address setting to 0.)

Setting Unit Addresses (Loop Control Units Only)

- 1, 2, 3... 1. After completing the settings described above, select the title (LC001-1 to LC001-3). Select **Network Settings** from the Settings menu and the following dialog box will be displayed.

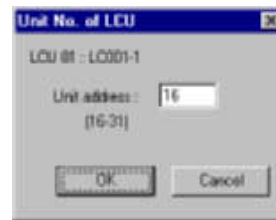

2. Input the unit address in decimal (16 to 31) in the unit address field. Set the value calculated by adding 16 (10 Hex) to the CPU Bus Unit unit number setting (0 to 15, or 0 to F Hex) set on the front of the Loop Control Unit.

If the unit address setting is not correct (16 + the unit number setting), it will not be possible to connect the Loop Control Unit online.

Note The unit address is input in decimal (16 to 31) with the CX-Process Tool.

3. After inputting the unit address, click the **OK** Button.

Note The node address must be set whether a Host Link (SYSMAC WAY) or Peripheral Bus (Toolbus) connection is being used. If the node address setting is incorrect, an error will occur in downloading operations and the following error message will be displayed in the dialog box: *Error occurred during Clear All. ERROR CODE 0401 or 0202.*

Note When CX-Server has been selected (Host Link or Peripheral Bus connection), the PLC model and CPU that were set in the Change PLC Dialog Box will be displayed next to the title in the Project Workspace. Also, the unit address setting of the Loop Controller will be displayed next to the LCU/LCB element name, as shown in the following diagram.

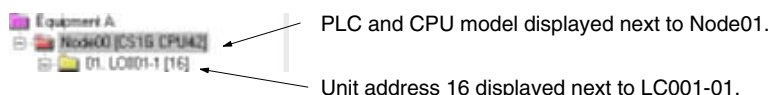

4-2-4 Peripheral Bus (Toolbus) Connections

Initial Settings

The initial Unit settings are the same as the settings for FinsGateway, although the Peripheral Bus connection can be used to connect to the CPU Unit only. Set the CPU Unit's serial communications mode to Peripheral Bus mode.

- Turn OFF pin 4 (or the PRPHL for a CS1D Duplex System) of the DIP Switch when using the peripheral port.

- Turn ON pin 5 (or the COMM pin for a CS1D Duplex System) of the DIP Switch when using the RS-232C port. Also, set the appropriate word in the PLC Setup (Programming Console address 160) to 0400 Hex.

**Initial Settings in
CX-Process Tool**

After completing the steps described above, take the following steps in the CX-Process Tool.

- 1, 2, 3...**
1. Select **Change PLC** from the Settings Menu.
 2. The Change PLC Dialog Box will be displayed.
Select **Toolbus** (Peripheral Bus) as the network type.
 3. If necessary, the Network Settings Dialog Box can be displayed by clicking the **Settings (S)** Button next to the network type.
The port name (COM port number) can be selected in the Driver Tab.

Note When CX-Server has been selected as the communications driver, set the node address to a non-zero value in the Network Settings Dialog Box before compiling the Monitor tag file or CSV tag file. Select **Change PLC** from the Settings Menu to display the dialog box. (If the computer is connected online, return the node address setting to 0.)

**Setting Unit Addresses
(Loop Control Units
Only)**

The unit address setting for the Peripheral Bus connection is the same as the unit address setting for the serial connection. Refer to *Setting Unit Addresses* on page 249 for details.

4-3 Downloading, Uploading and Comparing Data

The specified LCU/LCB element data or function block data in a function block file (.ist) can be downloaded to RAM in the Loop Controller. The specified LCU/LCB element data or function block in RAM in a Loop Controller can be uploaded to the specified LCU/LCB element or function block file or compared with other files. (In the following description, transferring from the personal computer to the Loop Controller is called downloading and transferring from the Loop Controller to the personal computer is called uploading.)

With an LCB□□, after downloading the function block data to RAM in the Loop Controller, the data can be backed up in flash memory in the Loop Controller by selecting the option *LCB backup indication after download*. Refer to *4-8 Backup and Recovery* for details.

Data to be downloaded, uploaded, or compared can be in the following units in addition to units of LCU/LCB elements or function blocks.

| Selected item(s) | Download | Upload | | Compare |
|--|------------------------------|--------------|--------------|-------------------------|
| | | Previous | New | |
| Two or more LCU/LCB elements | Not possible | Not possible | Not possible | OK (between files only) |
| One LCU/LCB element | OK | OK | OK | OK |
| One item in a step ladder program (sequence control directory) | Not possible | OK | OK | OK |
| One ITEM | OK (Operation data (O) only) | Not possible | Not possible | Not possible |

The following data can be downloaded, uploaded, or compared.

| Data | Description |
|---|---|
| Initial settings (S) | Initial settings in the function blocks in the data for an LCU/LCB element in the function block file (.ist) and mnemonic data in step ladder programs. Note The above includes registered function blocks (data on block address allocations) and data on software connections for analog and accumulator signals. |
| Operation data (O) | Operation data on the function blocks in the data for an LCU/LCB element in the function block file (.ist) |
| Initial settings and operation data (S and O) | The data for an LCU/LCB element in the function block file (.ist) and the mnemonic data in step ladder programs. |

Note The classification of initial settings (S) and operation data (O) items are shown in the *Type* column in the list of ITEMS for each function block.

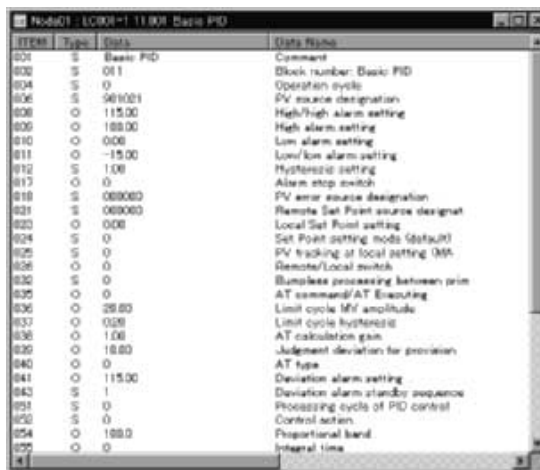

The classification can be checked using the following details in the *Function Block Reference Manual*.

S: Initial settings (set with CX-Process Tool)
 O: Operation data (set with either CX-Process Tool or CX-Process Monitor)

| ITEM type | ITEM | R/W method R: Read, W: Write, R/W: Read and write, ---: R/W disabled r, t/w: CX-Process Tool operation monitor/Operation monitor read and write (S): Initial setting data, (O): Operation data | Data length (bytes) | | | |
|------------------------------|------|--|---------------------|--------------------|------------------|---------------------|
| | | | CX-Process Tool | CX-Process Monitor | ITEM write block | Step ladder program |
| Contact input | 000 | --- | --- | --- | R/W | 1 |
| Parameter | 001 | R/W | --- | --- | --- | 2# |
| | 002 | R/W | --- | --- | --- | 2 |
| Special | 003 | r | --- | --- | --- | 2 |
| Parameter | 004 | R/W (S) | --- | --- | --- | 2 |
| Measurement PV | | | | | | |
| Analog input connection data | 006 | R/W (S) | --- | --- | --- | 4 |

Note The function block file (.ist) can be downloaded to and uploaded from the Loop Controller and compared with other files regardless of the operation mode of the CPU Unit.

4-3-1 Downloading (Transfer to LC)

Specified LCU/LCB elements (LCB01/03/05/00, or LC001 to LC003) or function blocks can be transferred to the Loop Controller.

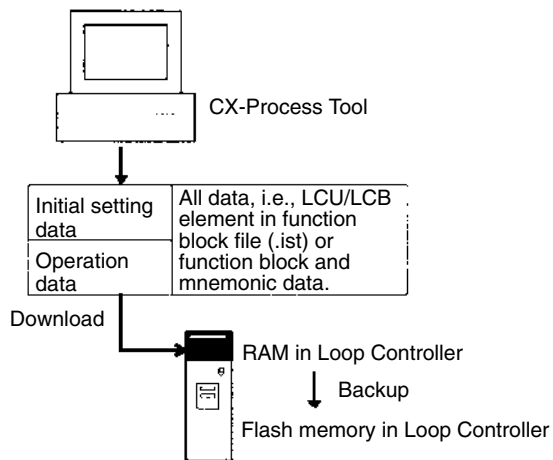

The following functions are supported for downloading.

- Function block data (i.e., LCU/LCB elements, function blocks, or ITEMS) can be transferred to the RAM in the Loop Controller. (Selection can be made when transferring between initial data, operation data, or initial data and operation data.)
- The data stored in RAM is copied to the internal compact flash memory. (See note.)
- Tag data, comment data, and block diagram data is transferred to a Memory Card or to the internal flash memory (refer to 4-9 *Transferring Tag and Comment Data* on page 309 for details). (See note.)

Note This function is supported for the LCB□□ only.

Any of the functions can be selected by setting the required option when downloading.

- Note**
1. The default values for each function block are transferred as operation data when downloading function blocks. Default values are also transferred to output ITEMS (e.g., MV) if function groups are downloaded while the Loop Controller is in operation. Confirm the status of connected devices before downloading.
 2. To check the compatibility of the Loop Controller version for the online connection and the CX-Process version before downloading, select **Check Version** from the Run Menu.

Restrictions for Loop Controller Model and Version

(1) Loop Controller Boards (LCB□□)

- Ver. 2.0 or Lower
If LCB□□ Ver. 2.0 or lower is used and a Memory Card is not installed in the CPU Unit, tag, comment, annotation, and block diagram line data will not be transferred. To transfer this data to a Memory Card, refer to 4-9 *Transferring Tag and Comment Data*.
When LCB□□ Ver. 3.0 or higher is used, tag, comment, and annotation data can be stored in the Loop Controller without a Memory Card.

(2) Loop Control Units (LC001)

- Ver. 2.0 or Later
Block diagram information can be transferred partially (only the layout data for the function blocks). Data on lines between function blocks created in block diagrams cannot be transferred.
- Ver. 1.5 or Earlier
Block connection line data is not transferred. Consequently, the block diagram will not be displayed when an upload is performed.

Precautions for Use of Step Ladder Program Blocks

- Step ladder programs created as ladder diagrams will not be transferred when ITEM 200 (mnemonic flag) for the step ladder block is 1. Always change ITEM 200 (mnemonic flag) to 0, convert into mnemonic code (assemble), and then perform the transfer.
- To perform an assembly operation for LCU/LCB elements, select **Execute – Assemble All**. For step ladder programs, select **Operation – Assembly**. Mnemonic code can be transferred when ITEM 200 (mnemonic flag) is 1.
- If a download is executed when ITEM 200 (mnemonic flag) is 0, assembly (i.e., conversion from ladder diagram to mnemonic code) will be automatically performed and mnemonic code will be downloaded (automatic assembly).

Downloading Procedure

- 1, 2, 3...**
1. Select the LCU/LCB element (LCB01, LCB03, LCB05, LCB05D, LC001-1 to LC001-3) or function block and select **Transfer to LC – Selected** from the Execute Menu.

The following dialog box will appear unless the data in function blocks are to be downloaded.



- Click the **OK** Button to overwrite the function block file in the destination Loop Controller. The following dialog box will appear unless the data in function blocks are to be downloaded.

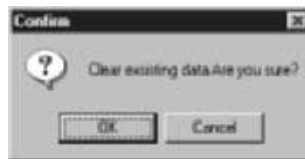

- The following dialog box will appear.

Select the field.

- Initial setting data (S): Initial settings for each function block and step ladder programs
- Operation data (O): Operating parameters for each function block. This cannot be selected for LCU/LCB element downloads.
- Initial setting data and operation data (S and O): All the above items (The data in an LCU/LCB element in the function block file (.ist) and mnemonic data)



With an LCB□□, checkmark selection boxes will be displayed in the dialog box. Turn these selections ON or OFF and then click the **Start** Button.

| Checkmark selection | Meaning |
|--------------------------------------|---|
| Update User Link Table Refresh Cycle | If this item is check marked, the refresh cycles for the tags in the user link table will be changed to the operating cycle for the function block to which the software connection is made. |
| Transfer FBD Information | This item is valid only when downloading by function block. (FBD information is automatically downloaded when an LCU/LCB element is downloaded.) If this item is selected, the layout information for the selected function block diagram will be downloaded. If this item is not selected, the layout information will not be downloaded. |
| Backup LCB Data to FROM | If this item is check marked, the data that is downloaded will also be backed up in flash memory in the Loop Controller. If this item is not selected, the data will not be backed up. |
| Transfer data to Memory Card | If this item is check marked, connection data, tags, comments, and annotations that are downloaded will also be backed up to the Memory Card. If this item is not selected, the data will not be backed up. Note This item is automatically selected when a Memory Card is installed in the CPU Unit. Supported for LCB□□ Ver. 2.00 or earlier only. |

Note If an error occurs, the following dialog box will appear and downloading will not be possible.

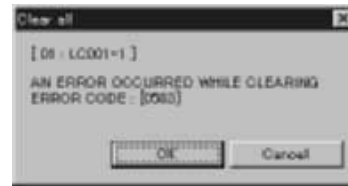

The error message will appear with an error code or a communications time-out notice. The probable cause can be determined from the error code.

| Error code | Probable cause |
|-------------------------|---|
| 0503 | Serial communications have not been initialized. |
| 0202 | Unit address setting error. The unit address is not for a Loop Controller. |
| | No I/O tables have been created. |
| 0401 | Node address setting error (i.e., the address set is not 01 for Host Link communications). |
| 0101 | The baud rate in the Controller Link does not match. |
| 110C | The number of step ladder program instructions per LCU/LCB element exceeds 4,000. |
| | Even though ITEM 059 in the Loop Controller's System Common block (block model 000) is set to 0 to enable using the HMI, the EM Area bank specified in ITEM 050 (EM Area bank to allocate to HMI) cannot be used because the specified bank does not exist in the CPU Unit or the specified bank has been converted to file memory. |
| Communications time-out | The CPU Unit is not in Host Link serial communications mode or the CPU Unit's communications conditions are wrong. (DIP switch settings or PLC Setup settings are wrong.) |

4. Click the **Start** Button. A bar will appear and show the progress of data downloading. The following dialog box will appear on completion of data downloading.

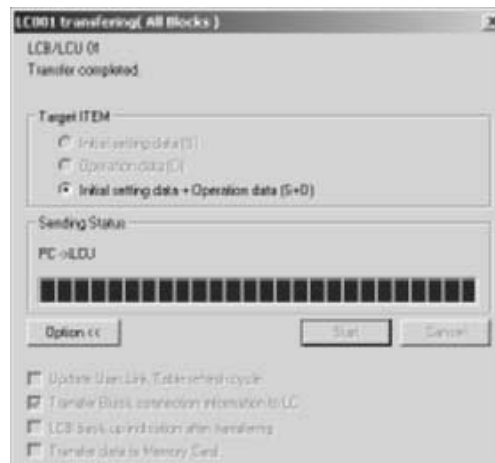

5. The box will be closed automatically when processing is completed.

Note 1. After the data in an LCU/LCB element in the function block file is downloaded, the Loop Controller will stop operating. The Loop Controller will not stop operating if function blocks are downloaded. To start the Loop Controller again, select **Operation** and **Run/Stop Command** from the Execute Menu. Then select **Hot Start** or **Cold Start** from the Run/Stop Command Dialog Box or turn the PLC OFF and ON. When the PLC is turned OFF and

ON, the hot or cold start function will be controlled by the start mode of ITEM018 of the System Common Block. The Loop Controller will stop operating after the data in an LCU/LCB element in the function block file is downloaded. The Loop Controller will not stop operating if function blocks are downloaded. The following dialog box to confirm the start of operation will be displayed after downloading. Execute the operation command as required.

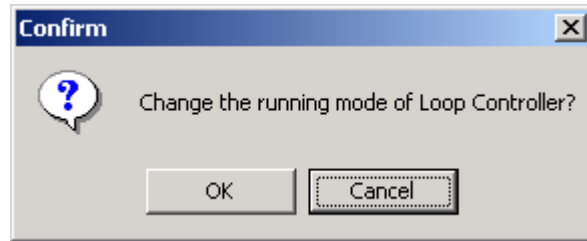

Other Methods for Starting Operation

- Turn the CPU Unit’s power supply OFF and then ON. (A hot or cold start will be performed according to the start mode for System Common block ITEM 018.)
- Execute the Operation Command from the Menu.

Transferring ITEMS

Layout information for the block diagram is not downloaded when an individual function block is downloaded. Always download the entire LCU/LCB element when layout information has changed.

It is also possible to download just the individual ITEM data (operation data only) that was set from a function block’s ITEM List. It is also possible to download just the individual ITEM data (operation data only) that was set from a function block’s ITEM List. The ITEM’s setting can be downloaded from the Setting ITEM List (a) or Monitor ITEM List (b) as described below. Only operation data (Type O in the ITEM List) can be downloaded.

a) Downloading from the Setting ITEM List

- Double-click the desired ITEM in the Setting ITEM List.
- Input the desired value and click the **Transfer to LC** Button.

Note In this case, the displayed value will be the computer’s offline value and not the value in the Loop Controller.

b) Downloading from the Monitor ITEM List

- Select **Monitor/ITEM List** from the Execute menu or pop-up menu.
- Input the desired value and click the **Transfer to LC** Button.

Note In this case, the displayed value will be the value in the Loop Controller.

Transferring Block Diagram Data

This function can be performed if LCB□□ Ver. 2.0 or earlier is used. Only the layout data for the function blocks in the block diagram is transferred to the Loop Controller. Block diagram layout data cannot be transferred when function blocks are downloaded. Therefore, if the diagram layout data has changed, select **Execution – Transfer to LC – FBD Information** and transfer the diagram layout data for function blocks to the Loop Controller.

Transferring to Memory Card and Internal FROM

Refer to 4-9 *Transferring Tag and Comment Data* for details.

4-3-2 Uploading (Transfer from LC)

The function block data in the Loop Controller can be transferred to the computer.

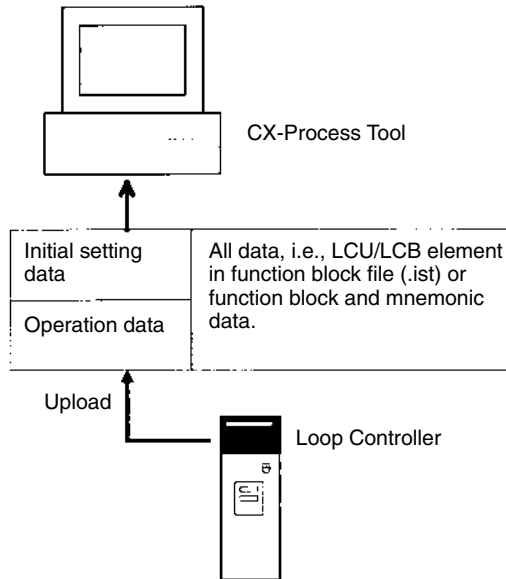

The following functions are executed in the upload.

- Function block data (i.e., LCU/LCB elements and function groups) can be transferred from the RAM in the Loop Controller to the computer.
- Tag data, comment data, and block diagram data can be transferred from a Memory Card or internal flash memory to the computer (refer to 4-9 *Transferring Tag and Comment Data* for details) (see note).

Note This function is supported for the LCB□□ only.

The following two types of data uploading are available.

1) Upload New (New Transfer from Loop Controller to Computer)

A new function block file will be created and the function block data in the Loop Controller will be saved in it. Function block data in units of LCU/LCB elements can be read in this method.

Select this method if there is no function block file as a base of the function block data in the Loop Controller.

Precautions and Restrictions for Loop Controller Model and Version

(1) Loop Controller Boards (LCB□□) Ver. 3.0

- Ver. 3.0

Block diagrams are displayed when an upload is performed. Data on tags, comments, annotations, and block diagram lines transferred when downloading was performed will be restored.

- Ver. 2.0 or Earlier

Memory Card Not Installed

Block diagrams are displayed when an upload is performed. Block diagram line data, however, is not included, so lines are drawn automatically. Afterward, manually adjust the connection lines.

Memory Card Installed

Block diagrams are displayed when an upload is performed. Data on tags, comments, annotations, and block diagram lines transferred when downloading was performed will be restored.

(2) Loop Control Units (LC001)

- Ver. 2.0 or Later
Block diagrams are displayed when an upload is performed. Block diagram line data, however, is not included, so lines are drawn automatically. Afterward, manually adjust the connection lines.
- Ver. 1.5 or Earlier
Connection line diagrams between function blocks are not displayed after an upload is performed. (See note 1.) (To display connection line diagrams, first clear the ITEM data for the connection line data, and then it is necessary to connect lines.

Note At this time, the analog connection data as execution item data is not lost; it is saved. Therefore, the I/O for analog/accumulated values will be executed normally even if the data is downloaded to the Loop Controller and operation is performed. ITEM 200 (mnemonic flag) will automatically become 1 if a step ladder program (block model 301) is uploaded. Therefore, to display ladder diagrams, first set ITEM 200 (mnemonic flag) to 0 and then convert mnemonics to ladder diagrams.

2) Upload Previous (Update Transfer from Loop Controller to Computer)

If there is a function block file as a base of the function block data in the LCU/LCB element, the function block data in the Loop Controller will be read. Data can be read in units of LCU/LCB elements or function blocks.

Data on the Edit Block Diagram Screen will be displayed by using the block diagram information file. After function block data created with the CX-Process Tool is downloaded to the Loop Controller and the operation data is changed with the CX-Process Monitor, select this method if only the operation data needs to be refreshed.

To use this method for data in units of LCU/LCB elements, the source LCU/LCB element (LCB01, LCB03, LCB05, LCB05D, LC001-1 to LC001-3) currently opened with the CX-Process Tool must match the function block data in the Loop Controller in the following items.

- 1, 2, 3...**
1. Registered function block (block address vs. block model)
 2. Block diagram information
 3. Step ladder program in mnemonics

If the LCU/LCB element does not match with the function block data in item 1 or 2, the data with the same ITEM number in the function block with the same block address will be under any condition read (regardless of whether the block model matches or not). The data will overwrite the data currently opened. Therefore, the data currently opened may change to illegal data.

If the LCU/LCB element does not match with the function block data in item 3, the operation depends on the setting of ITEM200 (the Mnemonic Flag).

- When ITEM200 = 1, the mnemonic code that is read will not match the previous ladder diagram. Therefore, before uploading data in this method, it is recommended to compare the initial setting data items in the Loop Controller and check that the LCU/LCB element matches the function block data in item 1 through 3 (especially 1 and 2). Refer to 4-3-3 *Compare* for details.
- When ITEM200 = 0, the mnemonic code that is read is automatically disassembled (converted from Mnemonics to Ladder).

Note When a Step Ladder Program (Block Model 301) Is Uploaded

- ITEM 200 (Mnemonic Flag) Is 1
Ladder diagrams cannot be displayed. To display ladder diagrams, first set ITEM 200 (mnemonic flag) to 0 and then convert mnemonics to ladder.
- ITEM 200 (Mnemonic Flag) Is 0
Reverse assembly (i.e., conversion from mnemonics to ladder diagrams) will automatically be performed when the download is performed.

Upload New

To upload a new function block file, create the new function block file by taking the following steps 1 and 2 or insert LCU/LCB element data in the existing file and begin with step 3.

- 1, 2, 3...**
1. Select **New** from the File Menu.
 2. Create a multi-node folder.
 3. Select **Insert – Insert Node** from the Settings Menu and input the LCU/LCB element name (LCB01, LCB03, LCB05, LCB05D, LC001-1 to LC001-3).
 4. Select **Network Settings** from the Settings Menu to set the network address and node address.
 5. Select the LCU/LCB element. Select **Transfer from LC – New** from the Execution Menu.

The following dialog box will appear.

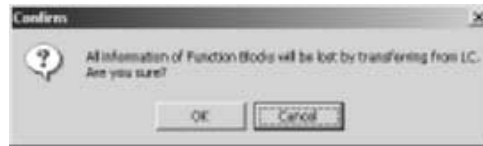

6. Click the **OK** Button.

The following dialog box will appear.

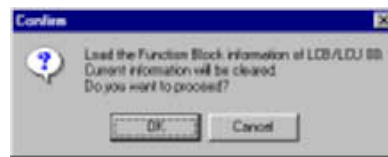

Note Here, data on the Edit Block Diagram Screen (function block information) will be lost and the block diagram showing the connections between function blocks will not be displayed. To display the block diagram, connect the function blocks again after the function block file is uploaded.

7. Click the **OK** Button.



8. Click the **Start** Button. The uploading of the new function block file will start. A dialog box will appear while the new function block file is uploaded.
9. The box will be closed automatically when processing is completed.

Upload Previous

- 1, 2, 3...**
1. Open the existing file of function block data in the Loop Controller.
 2. Compare the file and the function block data in the Loop Controller.
 - a) Select the LCU/LCB element or the function block to be refreshed. Select **Compare** from the Execute Menu.

- b) Select an LCU/LCB element from the File and Block to Compare field.
 - c) Set the level to initial setting data and operation data.
 - d) Click the **Compare** Button.
 - e) Check the comparison results and confirm that the file matches the data in registered function block and block diagram information. If they match, take step 3 below.
3. Select the LCU/LCB element (LCB01, LCB03, LCB05, LCB05D, LC001-1 to LC001-3) or the function block to be refreshed and select **Transfer from LC – Previous** from the Execute Menu. The following dialog box will appear.

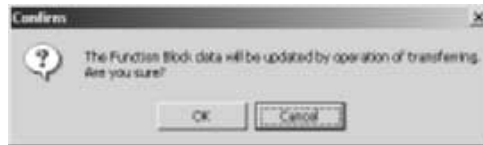

4. Click the **OK** Button.
The following dialog box will appear.



5. Click the **Start** Button.

Note If the data of the existing file currently opened with the CX-Process Tool does not match the function block data in the Loop Controller in the following item a) or b), the data currently opened will be illegal.

- a) Registered function block (block address vs. block model)
- b) Block diagram information

If the file does not match the data in item c) below and ITEM200 (the Mnemonics Flag) is set to 1, the mnemonics to be read will not match the ladder diagram.

- c) Step ladder program in mnemonics

- 6. The uploading of the previous data will start. A dialog box will appear while the data is uploaded.
- 7. The box will be closed automatically when processing is completed.

4-3-3 Compare

It is possible to compare the data in the currently active function block file and the data in the Loop Controller connected online. The data can be in units of LCU/LCB elements, sequence control folders in the function block group, or function blocks.

It is also possible to compare the data in the currently active function block file with the data in other files. The data can be compared in units of files, LCU/LCB elements, sequence control folders in the function block group, or function blocks.

Initial setting data or operation data or initial setting data and operation data can be selected for comparison.

Note Comparison between data in active function block files and comments, annotations, tags, or connection data that have been backed up in the Memory Card is not supported.

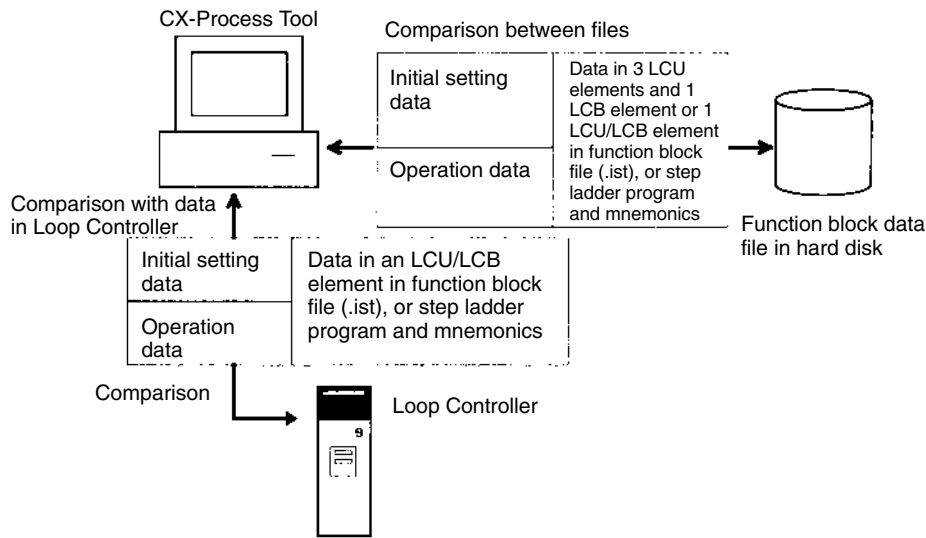

Comparison with Data in Loop Controller

Take the following steps to compare the currently active function block file with the function block data in the Loop Controller connected online. This method is used for either of the following purposes.

- To check before the Upload Previous Operation if the function block data in the Loop Controller matches the currently active function block file. In this case, the comparison is set for the initial setting data.
- To check if the data is downloaded or uploaded correctly. In this case, the comparison is set to both initial setting data and operation data.

1, 2, 3...

1. Select one of the following item and select **Compare** from the Execute Menu.
 - Comparison of a single LCU/LCB element: LCU/LCB element (LCB01, LCB03, LCB05, LCB05D, LC001-1 to LC001-3)
 - Comparison of a single function block: Function block
 - Comparison of a step ladder program: Sequence control folder
- The following dialog box will appear.

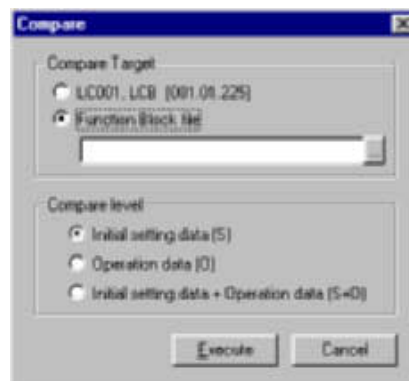

2. Select LC001 from the File and Block to Compare Field, provided that online connections are possible.
3. Select the level.

- Click the **Execute** Button. The comparison of the file and data will start. If they match, a message will be displayed as shown below to indicate that the comparison has been completed normally.



If they do not match, the details of the differences between them will appear.

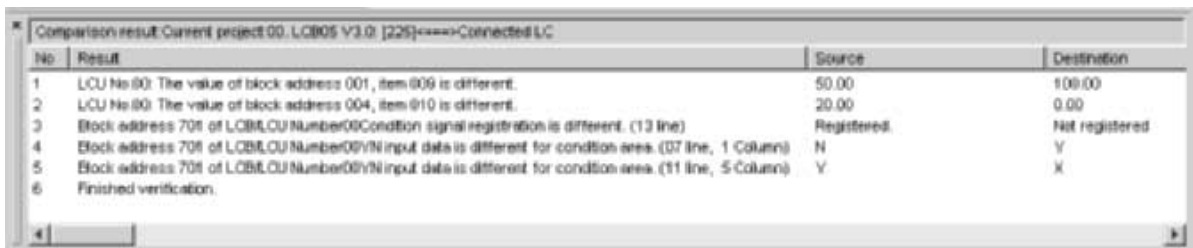

Comparison between Files

Take the following steps to compare the currently active function block file and mnemonics with another function block file and mnemonics.

Note The mnemonics in the function block file (.ist) are compared with the mnemonics in the mnemonics/ladder diagram information file (.mtd).

- 1, 2, 3... 1. Select one of the following items and select **Compare** from the Execute Menu.
 - Comparison of a number of LCU/LCB elements: Project Workspace
 - Comparison of an LCU/LCB element: LCU/LCB element (LCB01, LCB03, LCB05, LCB05D, LC001-1 to LC001-3)
 - Comparison with a single function block: Function block
 - Comparison of a step ladder program: Sequence control folder

The following dialog box will appear.

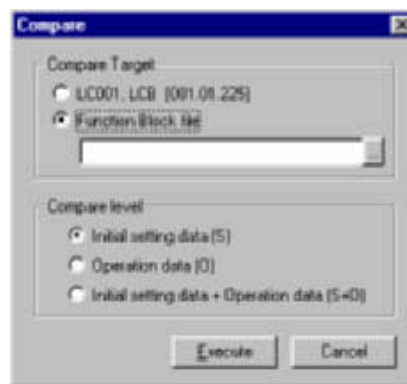

2. Select the function block file from the File and Block to Compare Field.

Click the button on the right of the function block file. The following Open Dialog Box will appear.

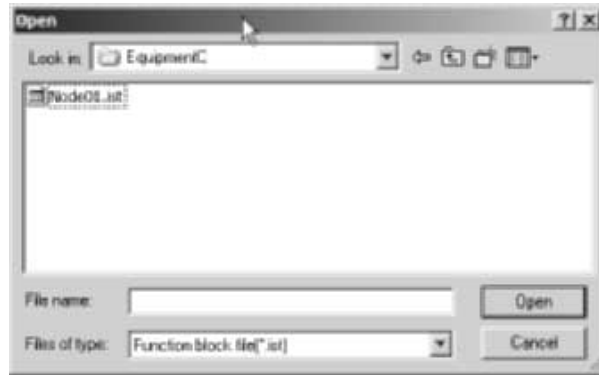

3. Select the file to be compared.

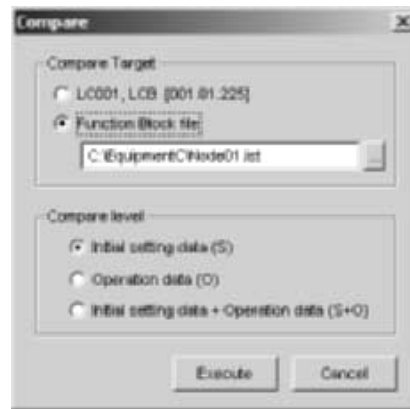

4. Select the level.

5. Click the **Execute** Button. The results will be displayed in the Output Window. If the data match, a message will be displayed to indicate that the comparison was completed normally. If they do not match, the details of the differences will be displayed as shown below.

Comparison result: Current project 00: LC805 V3 E: (225)=====Function Block file:C:\EquipmentC\node01.lst

| No | Result | Source | Destination |
|----|---|----------------|----------------|
| 1 | LCU No.88: The value of block address 001, item 029 is different. | 88.80 | 100.80 |
| 2 | LCU No.88: The value of block address 002, item 028 is different. | 115.00 | 90.80 |
| 3 | LCU No.88: The value of block address 002, item 029 is different. | 88.80 | 100.80 |
| 4 | LCU No.88: The value of block address 002, item 029 is different. | 18.80 | 5.00 |
| 5 | LCU No.88: The value of block address 004, item 029 is different. | 1.888 | 2.088 |
| 6 | LCU No.88: The value of block address 004, item 018 is different. | 28.80 | 0.00 |
| 7 | Block address 701 of LCB,LCU Number80Condition signal registration is different. (07 line) | Registered. | NOT registered |
| 8 | Block address 701 of LCB,LCU Number80Condition signal registration is different. (10 line) | NOT registered | Registered. |
| 9 | Block address 701 of LCB,LCU Number80Condition signal registration is different. (11 line) | Registered. | NOT registered |
| 10 | Block address 701 of LCB,LCU Number80Condition signal registration is different. (13 line) | Registered. | NOT registered |
| 11 | Block address 701 of LCB,LCU Number80Operation signal registration is different. (06 line) | Registered. | NOT registered |
| 12 | Block address 701 of LCB,LCU Number80YH input data is different for condition area. (12 line, 5 Column) | N | Y |
| 13 | Finished verification. | | |

4-4 Run/Stop Command

Run/stop commands can be sent from the CX-Process Tool to a Loop Controller connected remotely.

Run/Stop Commands

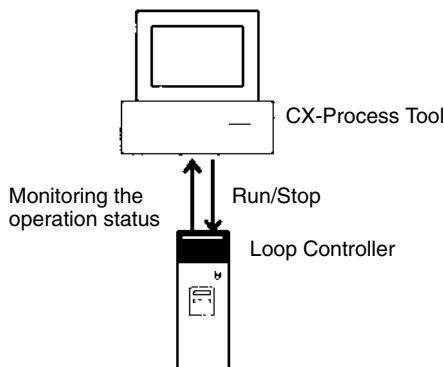

Caution Check the following items before operating the Loop Controller.

- Make sure the Analog I/O Units used with the Loop Controller are properly mounted.
- Make sure the unit numbers on the front panel of the Analog I/O Units coincide with the unit numbers set in the Field Terminal Function Blocks. Data for another Special I/O Unit will be read and written if an incorrect unit number is used.
- Make sure the initial settings in the System Common Block in the Loop Controller are correct. Check that the DM Area words for the Node Terminal Function Block in the CPU Unit of the Loop Control Unit will not be used for any other purpose.
- When writing data to the I/O memory in the CPU Unit with function blocks (e.g., using Send All Blocks, Expanded DO/AO Terminal to CPU Unit, or DO/AO Terminal to CPU Unit for a Loop Control Unit and using user link tables and the HMI function for an LCB□□), be sure that the words written to in the I/O memory are not being used for any other purpose. If I/O memory words are allocated to more than one purpose, the PLC system may act unexpectedly and cause injury.

Take the following steps to execute run/stop commands.

- 1, 2, 3... 1. Select **Operation** and **Run/Stop Command** from the Execute Menu. The following dialog box will appear.

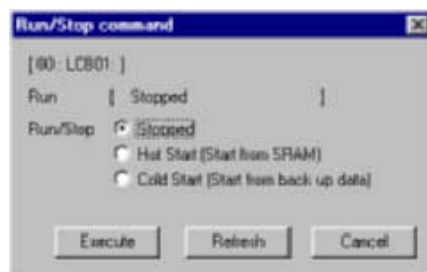

2. Select **Hot Start** to hot-start the Loop Control Unit/Board.
Select **Cold Start** to cold-start the Loop Control Unit/Board.

- Click the **Execute** Button. As shown below, **HOT START** or **COLD START** will appear in the Run Status Field.



- To stop operating the Loop Control Unit/Board, select **Stopped** and click the **Execute** Button.

Note The Run Status Field in the Run/Stop Command Dialog Box shows the status of the dialog box opened or with the **Execute** Button clicked. To refresh the status, click the **Refresh** Button.

- Note**
- If **Hot Start** or **Cold Start** is selected after downloading function block data that will change the operation cycle, a communications time-out error may occur. In that case, close the Run/Stop Command Dialog Box for approximately 30 seconds, and then open the dialog box again and select **Hot Start** or **Cold Start**.
 - A hot start or cold start will not be executed if **Hot Start** or **Cold Start** is selected and the **Execute** Button is clicked when backing up data during operation for the LCB01/LCB05 unit Ver. 1.5 or later, the LCB03, or the LCB05D. If an attempt is made, an error will occur (error code: 110C).

4-5 Monitor Run Status

4-5-1 Monitoring the System Run Status

It is possible to monitor or control the status of System Common Block of the Loop Controller. The following items can be monitored or controlled. This function is mainly used for checking the load rate or execution errors.

Monitor items: Present load rate, maximum load rate, operation cycle automatic change flag, minimum block address with an execution error, execution error code of each block address, block address with a database error, battery error, and ITEM data for System Common Block.

Control items: Maximum load rate and resetting operation cycle automatic change flag.

Monitor Run Status

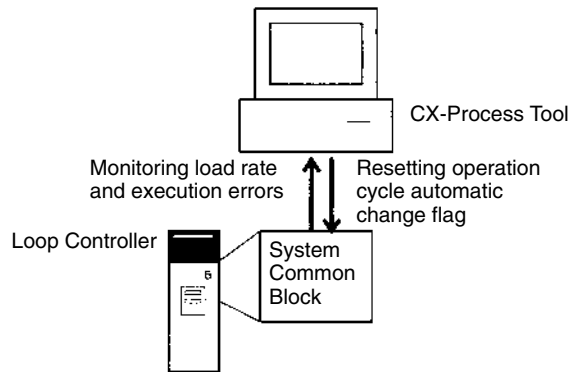

Note Do not apply function block data to practical use unless the suitability of the data for the system is fully checked with the CX-Process Tool, including a check on the load rate by selecting **Operation** and **Monitor Run Status** from the Execute Menu. For details on the load rate, refer to the operation manual for the Loop Controller.

Take the following steps to monitor the run status of System Common Block of the Loop Controller.

Select **Operation** and **Monitor Run Status** from the Execute Menu. The following dialog box will appear.

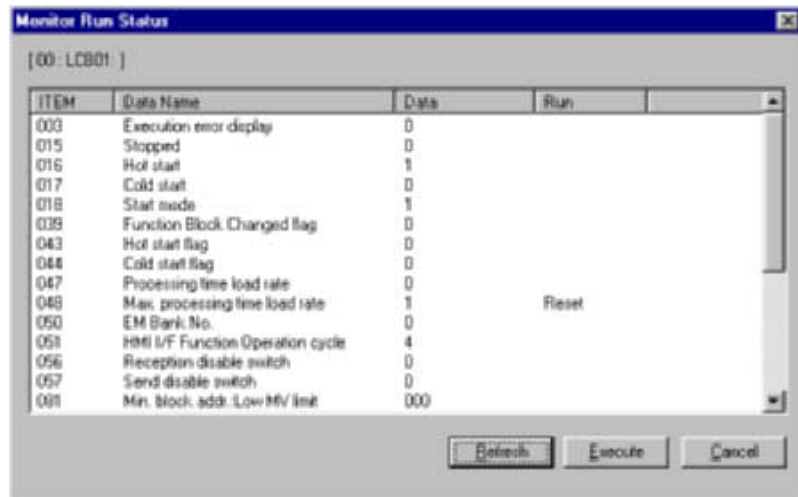

The ITEMS and data displayed on the Monitor Run Status Dialog Box is from the System Common block (block model 000). For details, refer to the list of ITEMS for the System Common block in the *Function Block Reference Manual*.

Note For a Loop Control Unit, the processing time load rate and maximum control load rate indication for each operation cycle block (e.g., ITEM 054 and ITEM 055), are indicated in 0.01% units. The data range is 0.00 to 100.00 (unit: 0.01%). For an LCB□□, the processing time load rate and maximum control load rate indication (LCB load rate and maximum load rate) for the overall Loop Controller for each operation cycle block (e.g., ITEM 047 and ITEM 048), are indicated in 1% units. The data range is 0 to 100 (unit: 1%).

- 1, 2, 3...
1. The values under the *Data* column are recorded when the Monitor Run Status Dialog Box is opened.
 2. To refresh the data with the dialog box displayed, click the **Refresh** Button.
 3. To execute the ITEM displayed under the *Run* column, select the ITEM and click the **Execute** Button.

4-5-2 ITEMS Marked “Reset”

Example

| | | | |
|-----|----------------------------------|------|-------|
| 051 | Processing time load rate | 0.01 | |
| 052 | Max. processing time load rate i | 0.01 | Reset |
| 053 | Operation Cycle Automatic Switch | 0 | Reset |
| 054 | Processing time load rate | 0.00 | |

ITEMs remarked “Reset” can be set to 0 (reset). Select the ITEM and click the **Execute** Button. The following dialog box will appear. Click the **OK** Button.

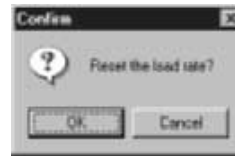

4-5-3 ITEMS Marked “Detailed display”

Example

| | | | |
|-----|----------------------------------|-----|-------------|
| 093 | Min. block addr. execution error | 000 | Show detail |
| 094 | Block addr. database error | 000 | Show detail |

The details of ITEMS remarked “Detailed display” can be changed through the Execution Menu.

Example: Minimum block address with an execution error resulted

The error code (i.e., the value stored in ITEM003) for each function block will be displayed in the block address with the vertical row specifying the 10’s digit in the block address and the horizontal row specifying the 1’s digit in the block address.

- 1: Block address not used
- 0: Normal (Execution error code)
- Other (1 to 89): Error (Execution error code)

For details on execution error codes, refer to the Operation Manual for the Loop Controller, or *Function Block Reference Manual*.

Example: Minimum block address with an execution error is 002.

| | | | |
|-----|----------------------------------|-----|-------------|
| 093 | Min. block addr. execution error | 000 | Show detail |
|-----|----------------------------------|-----|-------------|

Example: Block address 002 with an execution error 1 (source/destination designation error) while registering block addresses 000, 001, 002, and 100.

Execution error code: 0 (Normal)
 Execution error code: 1 (Source/Destination designation error)
 Block address not used: -1

| BLOCK | 0 | 1 | 2 | 3 | 4 | 5 | 6 | 7 | 8 |
|-------|----|----|----|----|----|----|----|----|----|
| 000 | 0 | 0 | 0 | 0 | -1 | -1 | -1 | -1 | -1 |
| 010 | -1 | -1 | -1 | -1 | -1 | -1 | -1 | -1 | -1 |
| 020 | -1 | -1 | -1 | -1 | -1 | -1 | -1 | -1 | -1 |
| 030 | -1 | -1 | -1 | -1 | -1 | -1 | -1 | -1 | -1 |
| 040 | -1 | -1 | -1 | -1 | -1 | -1 | -1 | -1 | -1 |
| 050 | -1 | -1 | -1 | -1 | -1 | -1 | -1 | -1 | -1 |
| 060 | -1 | -1 | -1 | -1 | -1 | -1 | -1 | -1 | -1 |
| 070 | -1 | -1 | -1 | -1 | -1 | -1 | -1 | -1 | -1 |
| 080 | -1 | -1 | -1 | -1 | -1 | -1 | -1 | -1 | -1 |
| 090 | -1 | -1 | -1 | -1 | -1 | -1 | -1 | -1 | -1 |
| 100 | 0 | -1 | -1 | -1 | -1 | -1 | -1 | -1 | -1 |
| 110 | -1 | -1 | -1 | -1 | -1 | -1 | -1 | -1 | -1 |
| 120 | -1 | -1 | -1 | -1 | -1 | -1 | -1 | -1 | -1 |
| 130 | -1 | -1 | -1 | -1 | -1 | -1 | -1 | -1 | -1 |
| 140 | -1 | -1 | -1 | -1 | -1 | -1 | -1 | -1 | -1 |

If the block address has a RAM checksum error in the function block database, one of the following values will be displayed in the block address with the vertical row specifying the 10's digit in the block address and the horizontal row specifying the 1's digit in the block address.

- 1: Block address not used
- 0: Normal (no function block database error)
- 90: Database error in the function block (See note.)

Note For a database error in all the function blocks, the value will be indefinite.

Example: No database error while registering block addresses 000, 001, 002, and 100.

0: Normal (with no database error in function block)
 Block address not used: -1

| BLOCK | 0 | 1 | 2 | 3 | 4 | 5 | 6 | 7 | 8 | 9 |
|-------|----|----|----|----|----|----|----|----|----|----|
| 000 | 0 | 0 | 0 | -1 | -1 | -1 | -1 | -1 | -1 | -1 |
| 010 | -1 | -1 | -1 | -1 | -1 | -1 | -1 | -1 | -1 | -1 |
| 020 | -1 | -1 | -1 | -1 | -1 | -1 | -1 | -1 | -1 | -1 |
| 030 | -1 | -1 | -1 | -1 | -1 | -1 | -1 | -1 | -1 | -1 |
| 040 | -1 | -1 | -1 | -1 | -1 | -1 | -1 | -1 | -1 | -1 |
| 050 | -1 | -1 | -1 | -1 | -1 | -1 | -1 | -1 | -1 | -1 |
| 060 | -1 | -1 | -1 | -1 | -1 | -1 | -1 | -1 | -1 | -1 |
| 070 | -1 | -1 | -1 | -1 | -1 | -1 | -1 | -1 | -1 | -1 |
| 080 | -1 | -1 | -1 | -1 | -1 | -1 | -1 | -1 | -1 | -1 |
| 090 | -1 | -1 | -1 | -1 | -1 | -1 | -1 | -1 | -1 | -1 |
| 100 | 0 | -1 | -1 | -1 | -1 | -1 | -1 | -1 | -1 | -1 |
| 110 | -1 | -1 | -1 | -1 | -1 | -1 | -1 | -1 | -1 | -1 |
| 120 | -1 | -1 | -1 | -1 | -1 | -1 | -1 | -1 | -1 | -1 |
| 130 | -1 | -1 | -1 | -1 | -1 | -1 | -1 | -1 | -1 | -1 |
| 140 | -1 | -1 | -1 | -1 | -1 | -1 | -1 | -1 | -1 | -1 |

Note The unit Ver. of the Loop Controller can be monitored using ITEM 099 as shown below.

| ITEM | Data name | Data |
|------|------------------|------------|
| 099 | MPU/FROM version | V1.20V1.20 |

Indicates that a Loop Controller with Unit Ver. 1.20 is being used.

4-5-4 Checking Versions

Check whether the version of the Loop Controller connected online and the version of the CX-Process Tool are compatible. Check that the Loop Controller version and the version of the created project are compatible.

- 1, 2, 3...**
1. Enable communications with the Loop Controller.
 2. Select **Check Version** from the Execute Menu. The following Check Version Dialog Box will be displayed. The following Version Check Dialog Box will be displayed.

Compatible

The following dialog box will be displayed if the project data currently being created and the version match.

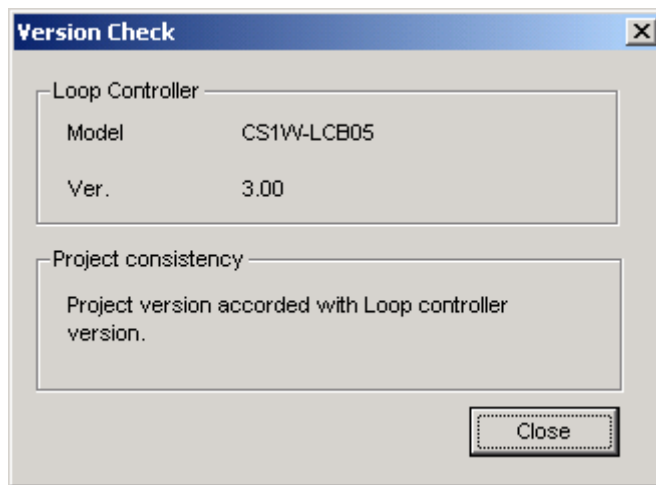

Incompatible

The following dialog box will be displayed if the project data currently being created and the version do not match. If they do not match, the project data format must be converted. Select **Change LC Type** from the Execution Menu.

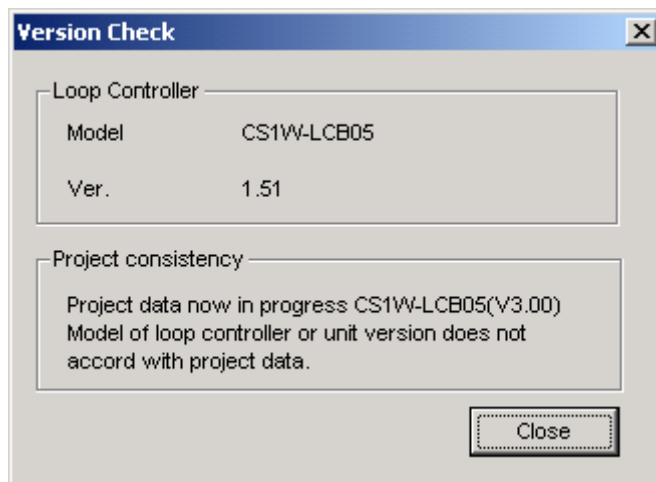



Note For the format conversion refer to 3-1-12 Editing Projects.

4-6 Operation Check

This section provides information on how to check the operation of the function block data in the Loop Controller. The following two types of checks are possible.

- 1, 2, 3...
1. Monitoring ITEM Data for Selected Function Blocks
 2. Downloading individual ITEM Data settings
 3. Operation Check of Block Diagrams
Checks if analog connections have been properly done.
It is possible to apply forced set/reset to analog signals.
 4. Operation Check of Sequence Tables or Ladder Diagrams
Checks sequence tables or ladder diagrams execution.
It is possible to apply forced set/reset to contact ITEMS.

 **WARNING** When the calibration function is executed, the MV (manipulated variable) will change due to changes in the PVs (present values) input to the control block. Therefore, set pseudo-input values to confirm safety when the MW changes before executing the calibration function. Devices may perform unexpected operations, resulting in serious accidents.

 **Caution** Compare the currently opened function block file and the function block data in the Loop Controller before checking the operation of the function block data. If the relationship between the block address and block model of the registered function block is incorrect, the operation of the function block data cannot be checked.

 **Caution** The operation of the function block data is checked according to the block address and ITEM numbers. If the function block file is different from the function block data in block model, the operation of the function block data will still be checked as long as the function block file is the same as the function block data in block address.

 **Caution** Analog or contact signals may be forcibly changed through the monitoring control of function block data. You must, however, confirm the safety of the whole system, otherwise the system or machine may operated unexpectedly.

Do not apply function block data to practical use unless the suitability of the data for the system is fully checked with the CX-Process Tool by selecting **Operation** and **Monitor Run Status** from the Execute Menu.

Perform the checks in the following sections to check the operation of each part of the system.

4-6-1 Monitoring ITEM Data for Selected Function Blocks

The ITEM data for a specified function block can be read from a Loop Controller and displayed.

- 1, 2, 3... 1. Select a function block that has been pasted.
2. Click the right mouse button to display the pop-up menu and select **Monitor/ITEM List**. The following dialog box will be display and the ITEM data can be monitored.

| ITEM | Type | ITEM tag | Data | Data Name |
|------|------|----------|-------------------|-------------------------------|
| 000 | | MT_ST | 0 | Stop block operation command |
| 001 | S | COMMENT | Basic PID | Comment |
| 002 | S | MODEL | 011 | Model:Basic PID |
| 003 | | ERR | 0 | Execution error display |
| 004 | S | CNT_TMEX | System common ... | Operation cycle(0:common) |
| 005 | S | SCAN_NO | 2000 | Operation order |
| 006 | S | PV_AD | 000.000 | PV source designation |
| 007 | | PV | 0.00 | PV input |
| 008 | O | HH_SP | 115.00 | High/high alarm setting |
| 009 | O | H_SP | 100.00 | High alarm setting |
| 010 | O | L_SP | 0.00 | Low alarm setting |
| 011 | O | LL_SP | -15.00 | Low/low alarm setting |
| 012 | S | HS_SP | 1.00 | Hysteresis setting |
| 013 | | HH | 0 | High/high alarm output |
| 014 | | H | 0 | High alarm output |
| 015 | | L | 1 | Low alarm output |
| 016 | | LL | 0 | Low/low alarm output |
| 017 | O | ADF | 0 | Alarm stop switch |
| 018 | S | PVE_AD | 000.000 | PV error source designation |
| 019 | | PV_ABN | 0 | PV execution error indication |
| 020 | S | ALM LIM | 0 | Alarm limit |

4-6-2 Downloading Individual ITEM Data Settings

It is also possible to change a single ITEM's data and download that ITEM's data to the Loop Controller, but only operation data (Type O in the ITEM List) can be downloaded this way.

- 1, 2, 3... 1. Double-click the ITEM that you want to change. A setting dialog box like the one in the following diagram will be displayed.

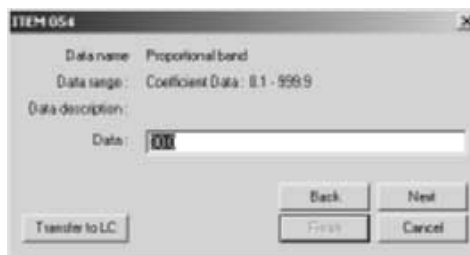

2. Change the data to the desired value and click the **Transfer to LC** Button. The changed value will be displayed in the ITEM List.

4-6-3 Block Diagram Check

This section provides information on how to check the block diagrams connecting the function blocks of a Loop Controller. The following data on the function blocks, excluding step ladder programs, will be displayed or set.

- Display of analog signal values
- Forced change of analog output signals
- Stop block operation/Cancel stop command for each function block

Operation Check of Block Diagrams

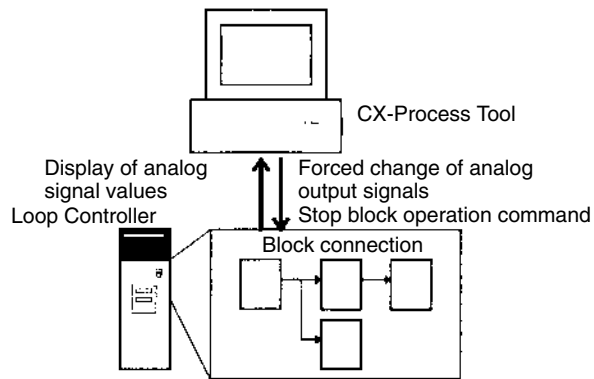

Changing to Block Diagram Validate Action Mode

Take the following steps to change the CX-Process Tool to Validate Action Mode.

- 1, 2, 3... 1. Select the block diagram folder and select **Edit/Block Diagram** from the Settings Menu. The block diagram will appear.
2. Select **Start** from the Validate Action Menu. The following screen will appear and the cursor will change to the  icon.

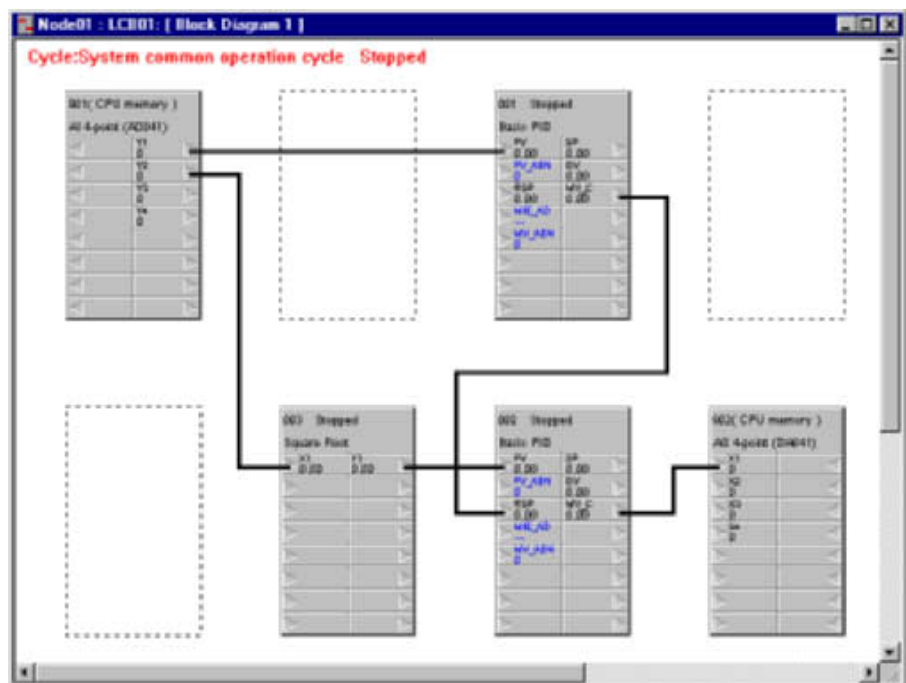

When the Loop Controller is not operating, “Stopped” in red will appear on the upper left. Nothing will be displayed when the Loop Controller is in operation.

The present values of the analog I/O ITEMS for all function block diagrams will be displayed.

If there is an execution error in a function block while the Loop Controller is in operation, the execution error code with the prefix ER will appear on the upper right of the function block.

Input value (0.00 in this example)

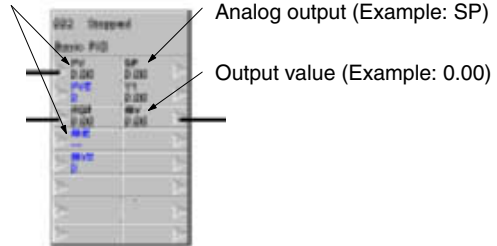

Connection Check

Check items 1 and 2 below to determine if the function blocks are connected correctly.

- 1, 2, 3... 1. Outputting the Source Function Blocks

In the above example, check on the output side (right side) of the function block that output Y of the source Square Root Block is 89.44.

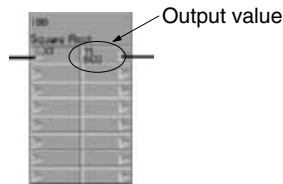

Note By double-clicking the source function block, the output value can be checked as well. The following Send Dialog Box will appear when the Square Root Block is double-clicked.

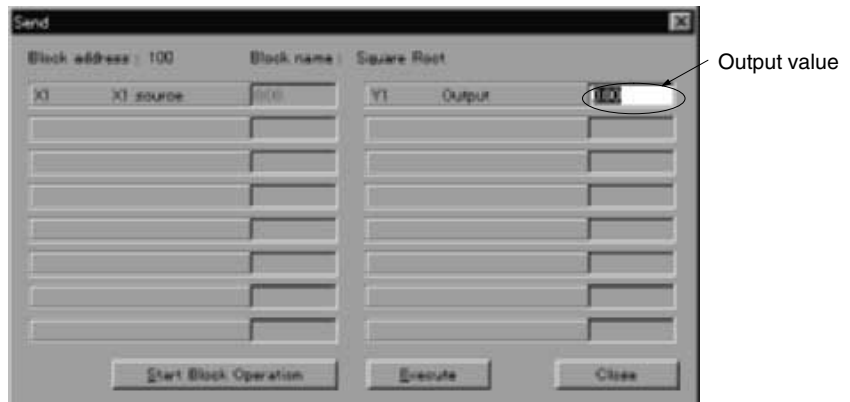

2. Input Value

Double-click the destination function block. The following Send Dialog Box will appear.

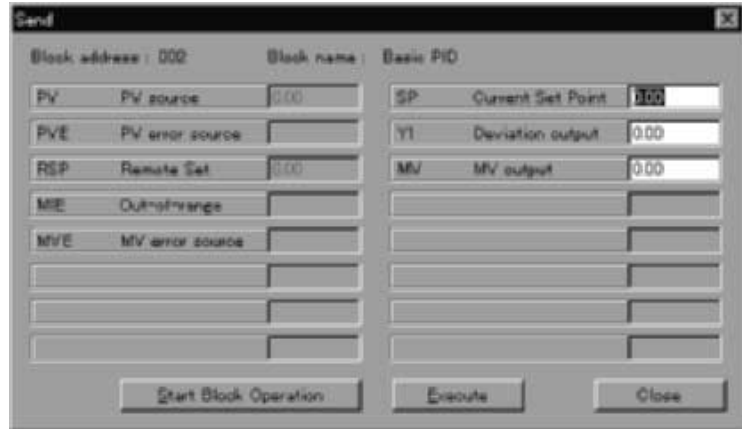

3. Check the input value in the dialog box.

In the above example, the grayed-out value on the right of the PV source designation reads 0.00.

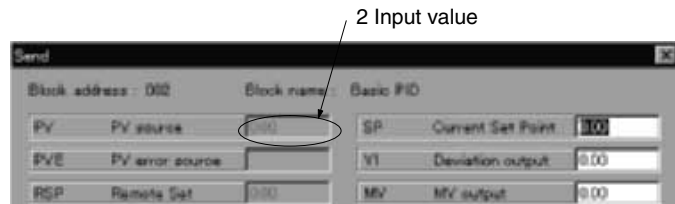

If the above item 1 matches item 2 in value, the connections are correct.

Stop Block Operation Command for each Function Block

From the above Validate Action Screen, the stop block operation command can be sent to each function block.

Take the following steps to execute the stop block operation command.

- 1, 2, 3... 1. Double-click the function block.

Example



The following Send Dialog Box will appear.

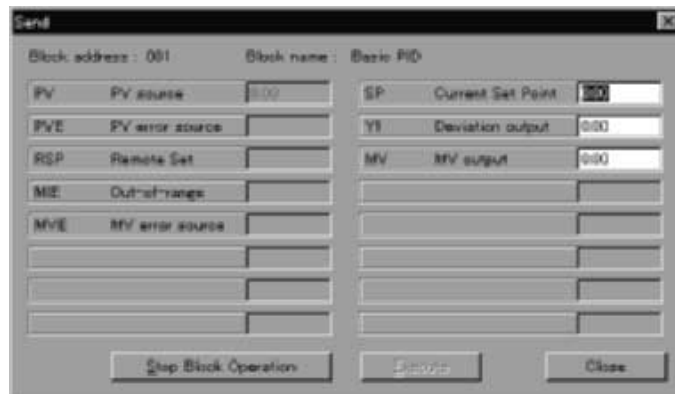

- Click the **Stop Block Operation** Button. The operation of the function block will stop and “Stopped” will appear at the top of the function block.

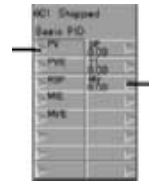

4-6-4 Wireless Debugging (LCB□□ Ver. 3.0 or Later Only)

The function for online debugging of created function blocks is referred to as the wireless debugging.

Calibration Mode

The present values for the control block can be force-set as pseudo-input values from the Monitor Run Status Window. The mode that performs pseudo-input using the wireless debugging function is called the Calibration Mode.

Starting Calibration Mode

Use the following procedure to set pseudo-values.

- 1, 2, 3... 1. Confirm the operation of block diagrams.
2. Right-click a function block for which the present values are to be changed and select **Wireless Debug** from the pop-up window.
3. The following dialog box will be displayed.



4. Select the *Calibration* Option for debugging settings in the dialog box.
5. The ITEMS that can be input and the values are determined by each function block. Input the values according to the following table.

ITEMS That Can Be Input in Calibration Mode

| Block model, function block | ITEM number | Possible ITEM setting | Maximum setting | Minimum setting |
|------------------------------|-------------|-----------------------|-----------------|-----------------|
| 001 2-position ON/OFF | 007 | PV (PV input) | 115.00 (%) | -15.00 (%) |
| 002 3-position ON/OFF | 007 | PV (PV input) | 115.00 (%) | -15.00 (%) |
| 011 Basic PID | 007 | PV (PV input) | 115.00 (%) | -15.00 (%) |
| 012 Advanced PID | 007 | PV (PV input) | 115.00 (%) | -15.00 (%) |
| 013 Blended PID | 007 | P1 (P1 input) | 9999 | 0 |
| 014 Batch Flowrate Capture | 007 | P1 (P1 input) | 9999 | 0 |
| 031 Indication and Setting | 007 | PV (PV input) | 115.00 (%) | -15.00 (%) |
| 032 Indication and Operation | 007 | PV (PV input) | 115.00 (%) | -15.00 (%) |
| 033 Ratio Setting | 007 | PV (PV input) | 115.00 (%) | -15.00 (%) |
| 034 Indicator | 007 | PV (PV input) | 115.00 (%) | -15.00 (%) |

6. Click the **OK** or **Apply** Button.
 - If the **OK** button is clicked, the settings will be reflected and the dialog box will close.
 - If the **Apply** Button is clicked, the settings will be reflected but the dialog box will not close.
7. The function blocks on the block diagrams will be displayed as in the following figure. (A CAL icon will be displayed in the upper-right corner.) ITEMS set as input values will be outlined.

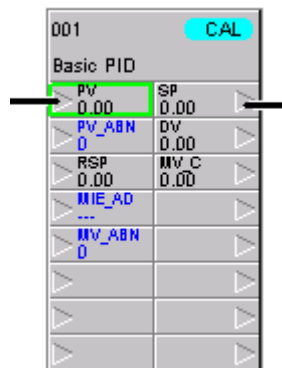

Exiting Calibration Mode

Use the following procedure to exit calibration mode.

- 1, 2, 3... 1. Confirm the operation of block diagrams
2. Right-click a function block for which the Calibration Mode is to be exited. Right-click and select **Wireless Debug** from the pop-up window.
3. A dialog box will be displayed. Select the None Option for debugging settings.
4. Click the **OK** or **Apply** Button.

4-6-5 Forced Changes to Analog Output Signals

From the above Validate Action Screen, analog output signal values can be changed forcibly after sending the stop block operation command to the function block. Take the following steps.

- 1, 2, 3... 1. Double-click the function block.

Example



The following Send Dialog Box will appear.



2. Click the **Stop Block Operation** Button.
 3. Change the analog output signal value.

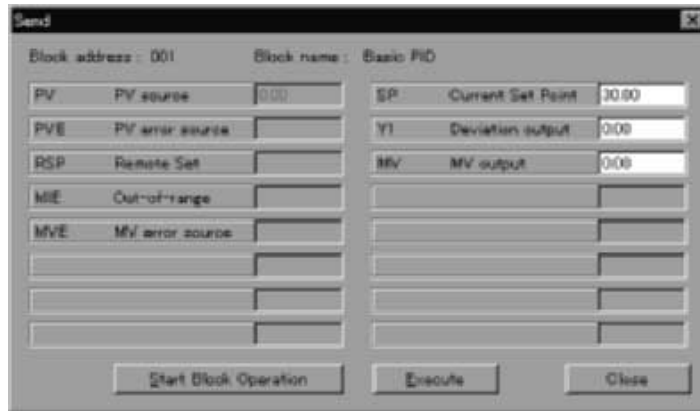

4. Click the **Execute** Button.

The function block in the block diagram will display the following changes.

- “Stopped” will appear on upper side of the function block.
- The SP has been forcibly changed to 30.00. Therefore, “30.00” will appear below the SP.

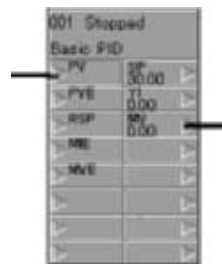

Note The new value must be within the permissible range of the ITEM, otherwise an error will result and the CX-Process Tool will end the

Validate Action Mode. Refer to the data range of each ITEM in the *Function Block Reference Manual*.

4-6-6 Ladder Diagram Operation Check

The following description provides information on how to check the operation of ladder diagrams for the Loop Controller in Validate Action Mode.

The following data of step ladders (block model 301) will be displayed or set.

- Display of the status of contact ITEM
- Force set or reset of contact ITEM
- Stop block operation/Cancel stop of function blocks incorporating contact ITEMS

Ladder Diagram Operation Check

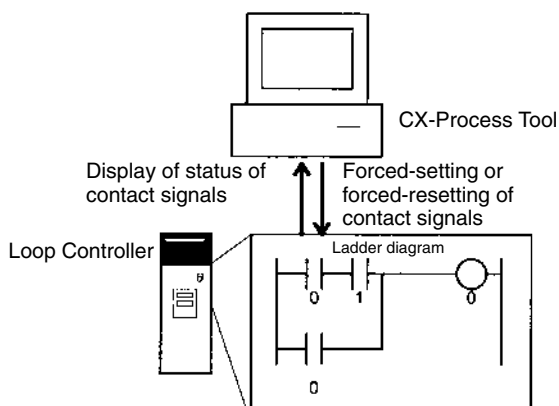

Changing to Ladder Diagram Validate Action Mode

Take the following steps to change the CX-Process Tool to Validate Action Mode.

- 1, 2, 3... 1. Select the block diagram folder and select **Edit/Step Ladder Program** from the Settings Menu. The ladder diagram will appear.
2. Select **Start** from the Validate Action Menu. The following screen will appear and the cursor will change to the  icon.

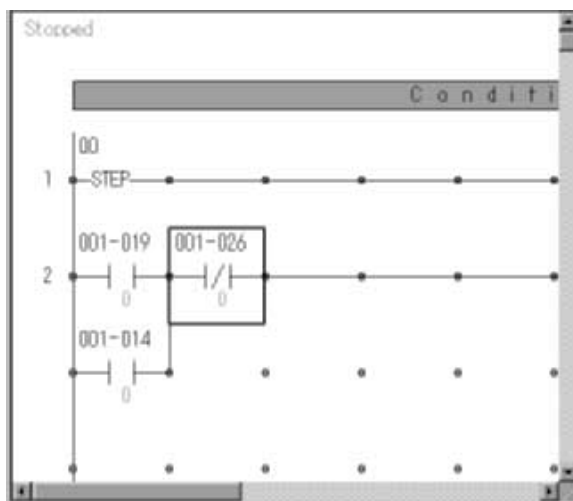

Displaying Contact ITEM Status

The status of the ITEM will be displayed by "1" or "0" below the contact.

Note For a normally closed contact, "0" will be displayed if the ITEM is 0. When the contact is closed, "1" will be displayed.

Example

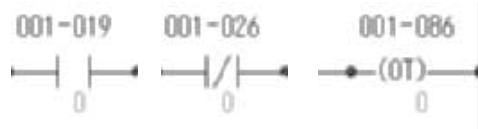

Forced-setting or Forced-resetting of Contact ITEMS

Take the following steps to set or reset the contact ITEMS.

Set or reset the input contact with the arithmetic operation of the source function block stopped. If it is an output contact, set or reset the contact with the operation of the destination function block stopped.

- 1, 2, 3... 1. Double-click the contact. The following Execute Dialog Box will appear.

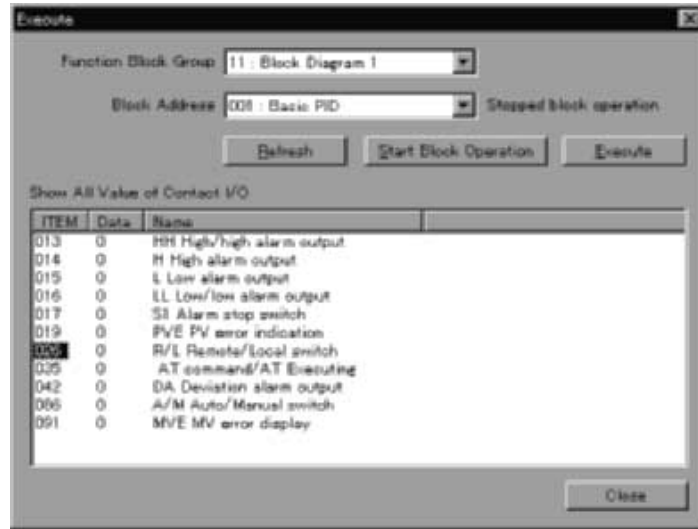

2. Double-click **ITEM** and change the data to 1. (Example: Change ITEM 026 to 1.)



3. Click the **Stop Block Operation** Button. (Example: 001. The operation of the Basic PID Block will stop.)

- Click the **Execute** Button. (Example: As shown below, "1" will appear under contact 001-026.)

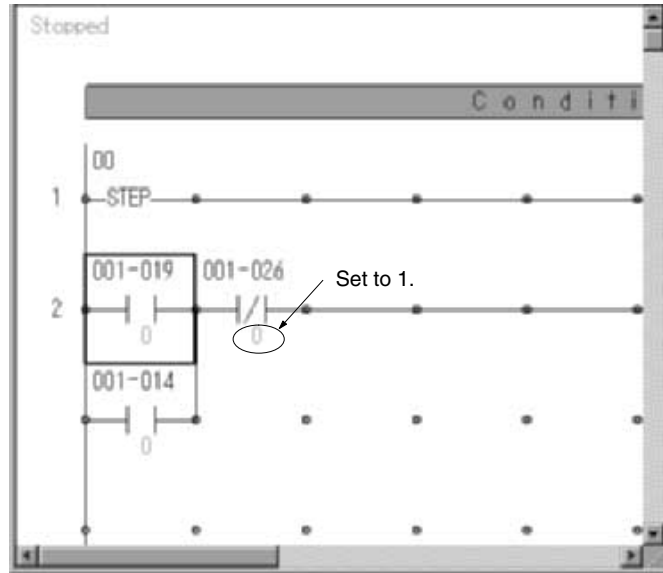

Note The following dialog box will appear if the transmission fails.

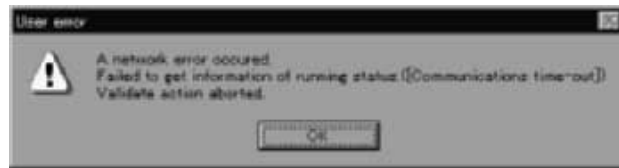

Note Not only the contact ITEMS used in the step ladder program, but also the contact ITEMS in function blocks and other contact ITEMS can be reset through the Execute Dialog Box.

Stopping Operation of Function Blocks with Contact ITEMS

Click the **Stop Block Operation** Button to stop the operation of the function block displayed in the block address (the basic PID in block address 001 in the following case).

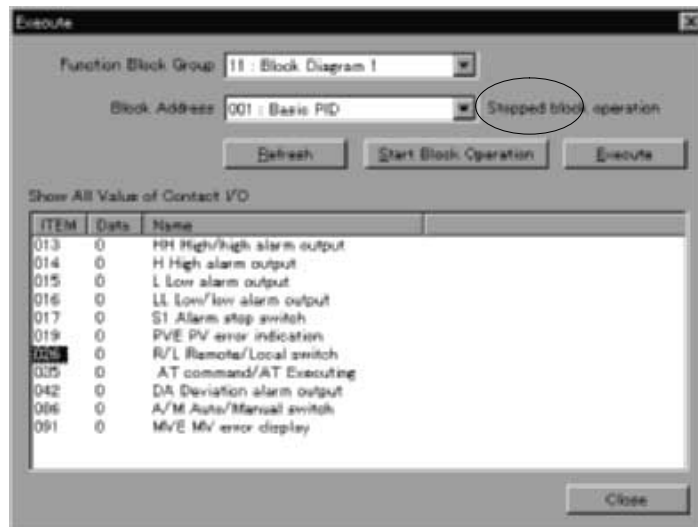

Restarting Function Blocks

Click the **Start Block Operation** Button in the Execute Dialog Box to make the operation of the function block displayed in the block address (the basic PID in block address 001 in the following case) resume.

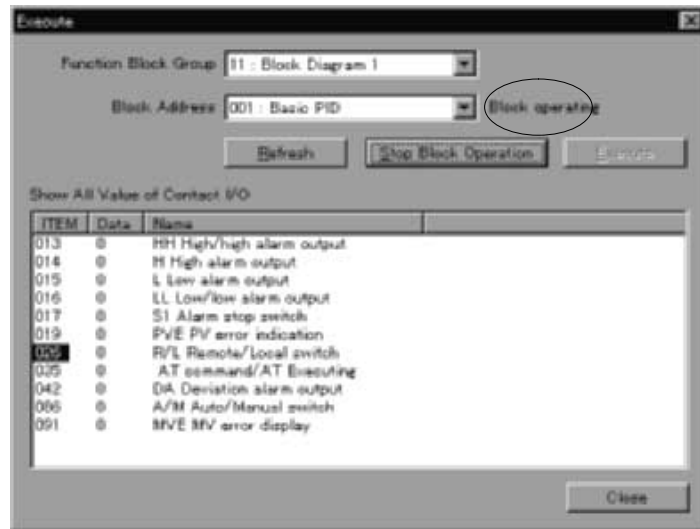

4-6-7 Validating Sequence Table Operation (LCB05/05D Only)

The operation of a sequence table in a Loop Controller can be validated (Sequence Table Validate Action Mode). The following can be checked in a sequence table (block model 302):

- Current step number
- Rule conditions (met/not met)
- Condition signal conditions (met/not met)
- Action signal conditions (met/not met)

Sequence Table Validation

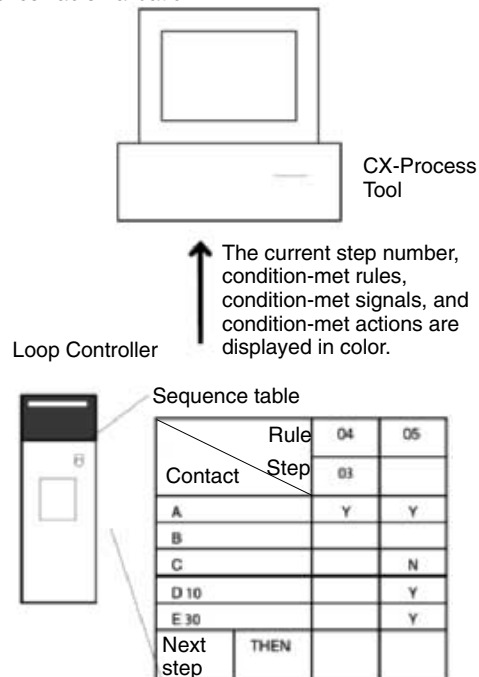

Entering Sequence Table Validate Action Mode
1, 2, 3...

- Use the following procedure to enter Sequence Table Validate Action Mode.
1. Select the sequence table block and select **Edit/Sequence Table** from the Settings Menu. The sequence table will be displayed.

- Select **Start** from the Validate Action Menu. The Action Validation Screen will be displayed as shown below. The cursor will change to the  icon. If the Loop Controller is not operating, *Sequence Table (Monitoring): Stopped* will be displayed.



| No. | Signal | Comment | Execution Form |
|-----|-----------------|------------------------|----------------|
| 001 | (IN) 001.019) | Run Start Flag | Y |
| 002 | (IN) T0001.HI) | | Y |
| 003 | (IN) 001.006) | Auto/Manual switch | Y N |
| 004 | (IN) 002.014) | High alarm output | N Y |
| 005 | (IN) 001.013) | High/high alarm output | N |
| 006 | | | |
| 007 | | | |
| 008 | | | |
| 009 | | | |

- Select **Operation** and then **Run/Stop Command** from the Execute Menu and implement a cold start or a hot start. The display will change to *Sequence Table (Monitoring)* and the sequence table execution status will be displayed. The colors displayed on the screen can be used to check the actions of the sequence table.

Conditions

Signal names
Red: Conditions met
Blue: Conditions not met

Set numbers
Red: Current step (indicated with red dot)
Blue: Other status

Rule numbers
Red: Conditions met
Blue: Conditions not met

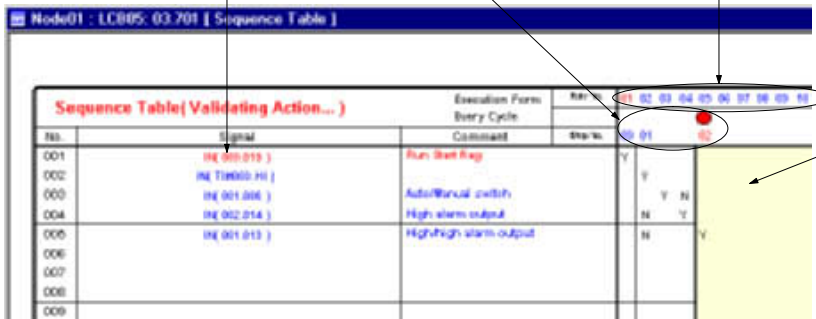

The value area for the current step is displayed in cream.

Actions

- Signal names
Orange with “1”: Actions being executed every cycle for output 1
Orange with “0”: Actions being executed every cycle for output 0
Red with “1”: Actions not being executed every cycle for output 1
Red with “0”: Actions not being executed every cycle for output 0

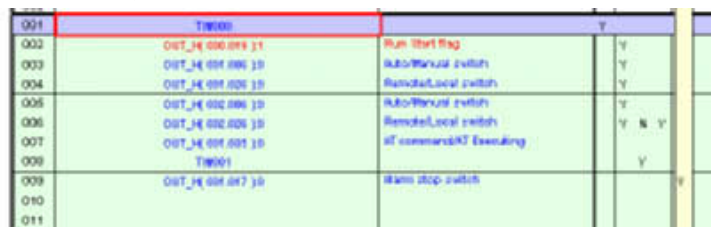

| | | | |
|-----|------------------|----------------------------|-------|
| 001 | T0000 | | Y |
| 002 | OUT_H 000.019 J1 | Run Start Flag | Y |
| 003 | OUT_H 001.006 J0 | Auto/Manual switch | Y |
| 004 | OUT_H 001.020 J0 | Manual/Local switch | Y |
| 005 | OUT_H 002.006 J0 | Auto/Manual switch | Y |
| 006 | OUT_H 002.026 J0 | Remote/Local switch | Y N Y |
| 007 | OUT_H 001.001 J0 | all commands NOT Executing | |
| 008 | T0001 | | Y |
| 009 | OUT_H 001.017 J0 | Alarm stop switch | Y |
| 010 | | | |
| 011 | | | |

Note ITEMS can be written during sequence table validation to check the operation of the sequence table. As shown below, change the value of the ITEM serving as

the signal in the function block ITEM list and then download the data. The results will be reflected in the sequence table.

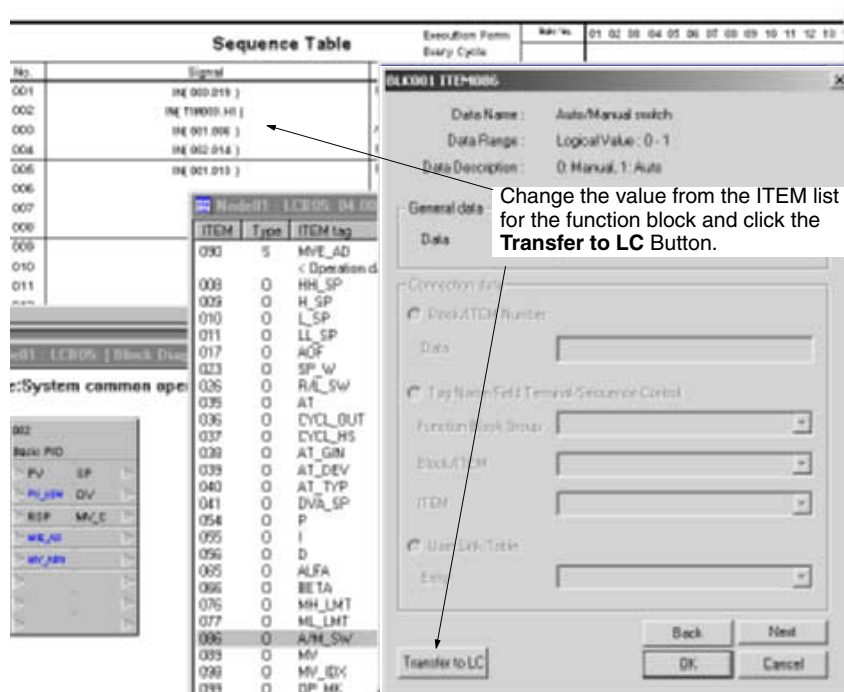

Edit Sequence Tables Online (CX-Process Tool Version 3.2 or Higher)

Caution When downloading a sequence table for the LCB05 (unit Ver. 1.5 or later) that has been edited online with the CX-Process Tool version 3.2 or higher, confirm that the system will operate normally with the edited sequence. If the sequence is not suitable for operation, unexpected operation may result.

Caution Confirm in advance the conditions at any node for which the sequence table is being edited over a Controller Link or Ethernet network. Not doing so may result in unexpected operation.

A sequence table can be edited online while the Loop Controller is running (see note) and while the sequence table is active without stopping step progression. To do this, the CX-Process Tool must be version 3.2 or higher and the LCB05 version 1.5 or later must be used.

Note Use the normal downloading procedure when the Loop Controller is stopped.

The following items can be edited online.

- Signals can be changed, added, or deleted for conditions and actions.
- Y/N specifications for rules can be changed, added, or deleted.
- Steps can be changed, added, or deleted.
- THEN sections can be changed, added, or deleted.

Note Rules and the number of conditions cannot be expanded.

Procedure for Online Editing

The sequence table is edited on the Action Validation Screen and then downloaded. This procedure is performed while the Loop Controller is running.

- 1, 2, 3... 1. Go online and select **Start** from the Validate Action Menu. Alternately, right-click and select **Validate Action – Start**.
The display will change to *Sequence Table (Validating Action)*.

| No. | Signal | Comment | Execution Form Every Cycle | Rule No. | | | | | |
|-----|------------------------|------------------------|-------------------------------|----------|----|----|----|----|----|
| | | | | Step No. | 01 | 02 | 03 | 04 | 05 |
| 001 | (N) Tag002.H01 | High/high steam output | | 00 | N | Y | | | |
| 002 | (N) Tag002.R1L_SW | Remote/Local switch | | | N | Y | | | |
| 003 | (N) Hot start_H_START | Hot start | | | Y | Y | | | |
| 004 | (N) Tag002.A/M_SW | Auto/Manual switch | | | Y | Y | | | |
| 005 | (N) L100001 Run Device | | | | Y | N | | | |
| 006 | | | | | | | | | |
| 007 | | | | | | | | | |
| 008 | | | | | | | | | |
| 009 | | | | | | | | | |
| 010 | | | | | | | | | |
| 011 | | | | | | | | | |
| 012 | | | | | | | | | |
| 013 | | | | | | | | | |
| 014 | | | | | | | | | |
| 015 | | | | | | | | | |
| 016 | | | | | | | | | |
| 017 | | | | | | | | | |
| 018 | | | | | | | | | |

2. Select **Edit – Start** from the Validate Action Menu. Alternately, right-click and select **Validate Action – Online Edit – Start**. Then select **Start** in the Verify Window.
The sequence table will be automatically verified. Online editing is not possible if the sequence table data is not the same in the CX-Process Tool and in the Loop Controller. If the data is the same, the display will change to *Sequence Table (Online Editing)*.

Online editing is displayed.

| No. | Signal | Comment | Execution Form Every Cycle | Rule No. | | | | | |
|-----|------------------------|------------------------|-------------------------------|----------|----|----|----|----|----|
| | | | | Step No. | 01 | 02 | 03 | 04 | 05 |
| 001 | (N) Tag002.H01 | High/high steam output | | 00 | N | Y | | | |
| 002 | (N) Tag002.R1L_SW | Remote/Local switch | | | N | Y | | | |
| 003 | (N) Hot start_H_START | Hot start | | | Y | Y | | | |
| 004 | (N) Tag002.A/M_SW | Auto/Manual switch | | | Y | Y | | | |
| 005 | (N) L100001 Run Device | | | | Y | N | | | |
| 006 | | | | | | | | | |
| 007 | | | | | | | | | |
| 008 | | | | | | | | | |
| 009 | | | | | | | | | |
| 010 | | | | | | | | | |
| 011 | | | | | | | | | |
| 012 | | | | | | | | | |
| 013 | | | | | | | | | |
| 014 | | | | | | | | | |
| 015 | | | | | | | | | |
| 016 | | | | | | | | | |
| 017 | | | | | | | | | |
| 018 | | | | | | | | | |

3. Edit the sequence table.

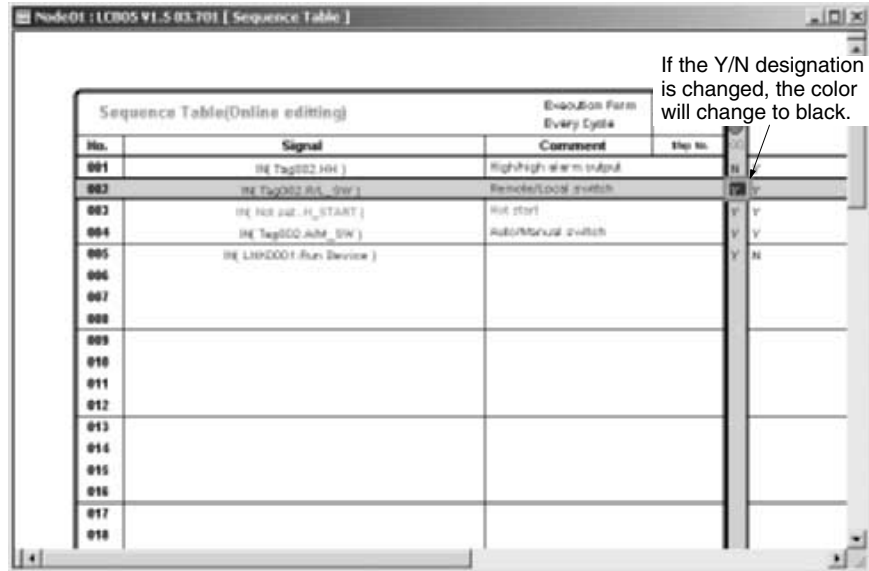

4. Select **Edit – Transfer to LC** from the Validate Action Menu. Alternately, right-click and select **Validate Action – Edit – Transfer to LC**.

The following dialog box will be displayed to download function blocks.

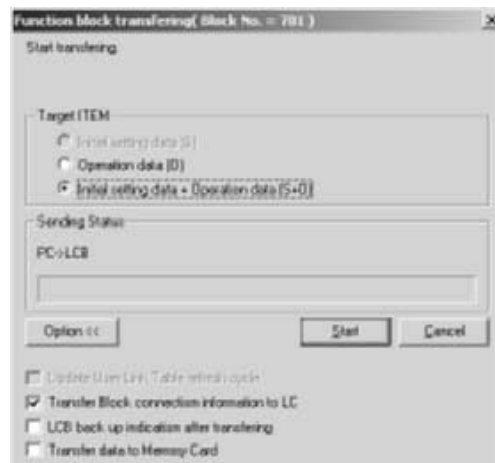

5. Click the **Start** Button. Downloading will be started and the sequence table including the edited data will be downloaded.

Operation will continue with the edited sequence table.

| Sequence Table(Online editing) | | | Execution Form Every Cycle | | | | | | |
|--------------------------------|-------------------------|------------------------|-------------------------------|----|----|----|----|----|----|
| No. | Signal | Comment | Run No. | 01 | 02 | 03 | 04 | 05 | 06 |
| 001 | RM Tag002.HH1 | High/High alarm output | Run No. | N | Y | | | | |
| 002 | RM Tag002.RL_SWITCH | Remote/Local switch | Run No. | Y | Y | | | | |
| 003 | RM RM3-INT-H_START | Hot start | Run No. | Y | Y | | | | |
| 004 | RM Tag002.AMR (SW) | Auto/manual switch | Run No. | Y | Y | | | | |
| 005 | RM (MPC001 Bus Reserve) | | Run No. | Y | N | | | | |
| 006 | | | | | | | | | |
| 007 | | | | | | | | | |
| 008 | | | | | | | | | |
| 009 | | | | | | | | | |
| 010 | | | | | | | | | |
| 011 | | | | | | | | | |
| 012 | | | | | | | | | |
| 013 | | | | | | | | | |
| 014 | | | | | | | | | |
| 015 | | | | | | | | | |
| 016 | | | | | | | | | |
| 017 | | | | | | | | | |
| 018 | | | | | | | | | |

Operation for Online Sequence Table Editing

- 1, 2, 3... 1. The Loop Controller will continue to operate during online editing from the CX-Process Tool.
2. When editing has been completed, the sequence table is downloaded to the Loop Controller. While the sequence table is being written to download it, the Loop Controller will operate with the previous sequence table.
3. When the sequence table in the Loop Controller has been completed downloaded, operation for the sequence table will continued from the step number from before the download. (See note.)

Note If, however, the conditions have been met to move to the next step, operation will be continued from the next step.

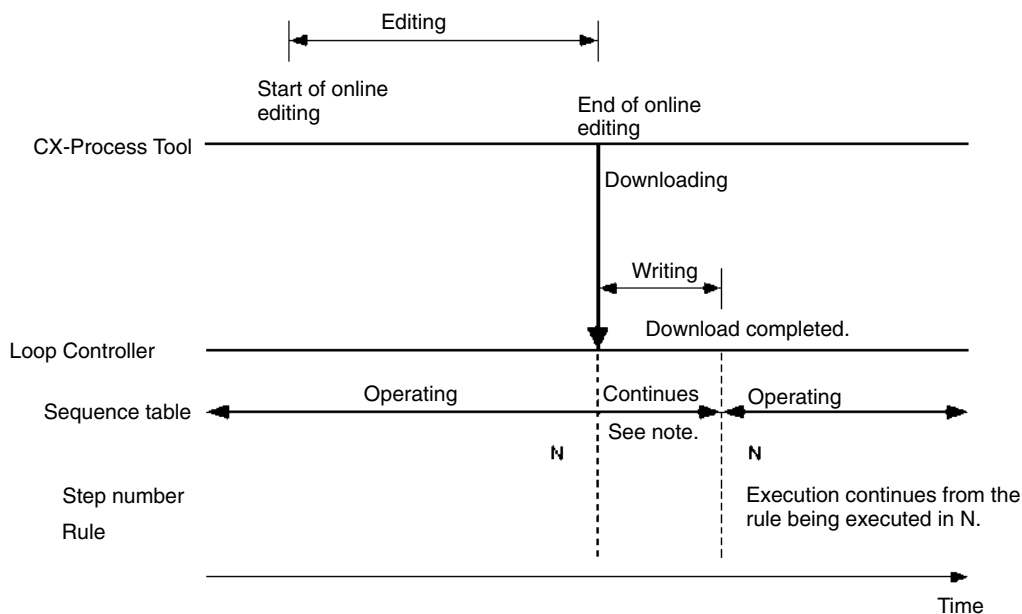

Note Operation continues with the sequence table from before the download.

Outputs

The operation of outputs after the download will be as shown in the following table according to the output status just before the download.

| Signal | Output type | Output status before download | Output status after download |
|----------------|---|-------------------------------|--|
| Outputs | Holding (OUT_H) | ON | OFF until the condition is met again |
| | | OFF | OFF |
| | Not Holding (OUT_L) | ON | ON |
| | | OFF | OFF |
| | Pulse (OUT_P) | ON | OFF (opposite status from last cycle) |
| | | OFF | ON (opposite status from last cycle) |
| | Flashing (OUT_F) | OFF and flashing | ON (opposite status from last cycle) and flashing |
| | | ON and flashing | OFF (opposite status from last cycle) and flashing |
| | | ON and not flashing | ON and not flashing |
| Table commands | STEP (specified step setting from other sequence table) | Condition already met. | Not executed. |
| | RUN (start from other sequence table) | | |
| | STOP (stop from other sequence table) | | |
| ITEM write | SET (constant write) | | |
| Elements | Timer | Still timing | Timing continues. |
| | Counter | Condition already met. | Not executed. |

The output status will be as shown in the following table when output signals are deleted during online editing.

| Signal | Output type | Output status after download | |
|-----------------------------------|---|--|---|
| Outputs | Holding (OUT_H) | Output will not function. | |
| | Not Holding (OUT_L) | If previously ON, will turn OFF and then will not function. | |
| | | If previously OFF, will remain OFF and then will not function. | |
| | Pulse (OUT_P) | OFF and then will not function. | |
| | Flashing (OUT_F) | If previously flashing | OFF and then will not function. |
| If previously ON and not flashing | | Output will not function. | |
| Table commands | STEP (specified step setting from other sequence table) | Not executed. | |
| | RUN (start from other sequence table) | | |
| | STOP (stop from other sequence table) | | |
| ITEM write | SET (constant write) | | |
| Elements | Timer | Still timing | Timing stops. |
| | Counter | Still counting. | The present value of the counter is held. |

Present Value Displays and Set Value Changes during Operation for Elements

The CX-Process Tool must be version 3.2 or higher, and the LCB05 unit Ver. 1.5 or later, or LCB03 must be used.

Present Values for Elements (Timers and Counters)

The present values of timers and counters will be displayed while validating sequence tables. The present values are displayed in parentheses following the TIM element numbers and CNT elements numbers in the *Element* column.

Action Validation on the Element Screen

The present value is displayed in parentheses after TIM/CNT and the element number. In this example, the present value of TIM 000 is 47.

| No. | Element | Comment | Set Value |
|-----|--------------|---------|-----------|
| 001 | TIM 000(47) | | 100 |
| 002 | CNT 001(200) | | 200 |
| 003 | | | |
| 004 | | | |
| 005 | | | |
| 006 | | | |
| 007 | | | |
| 008 | | | |
| 009 | | | |
| 010 | | | |
| 011 | | | |
| 012 | | | |
| 013 | | | |
| 014 | | | |
| 015 | | | |
| 016 | | | |
| 017 | | | |
| 018 | | | |
| 019 | | | |
| 020 | | | |
| 021 | | | |
| 022 | | | |
| 023 | | | |
| 024 | | | |
| 025 | | | |
| 026 | | | |
| 027 | | | |
| 028 | | | |
| 029 | | | |

Action Validation on the Sequence Table Screen

The present value is displayed in parentheses after TIM/CNT and the element number. In this example, the present value of TIM 000 is 100.

| No. | Signal | Comment | Seq No. |
|-----|--------------|---------|---------|
| 001 | TIM 000(100) | | 1 |
| 002 | CNT 001(200) | | 1 |
| 003 | | | |
| 004 | | | |
| 005 | | | |
| 006 | | | |
| 007 | | | |
| 008 | | | |
| 009 | | | |
| 010 | | | |
| 011 | | | |
| 012 | | | |
| 013 | | | |
| 014 | | | |
| 015 | | | |
| 016 | | | |
| 017 | | | |
| 018 | | | |
| 019 | | | |
| 020 | | | |
| 021 | | | |
| 022 | | | |
| 023 | | | |
| 024 | | | |
| 025 | | | |
| 026 | | | |
| 027 | | | |
| 028 | | | |
| 029 | | | |

Changing Set Values, Adding, and Deleting Elements (Timers and Counters) during Operation

Changing Set Values

The set value of a timer or counter can be changed while the Loop Controller and sequence table are operating.

- 1, 2, 3... 1. During sequence table operation, double-click the element in the Element Screen. Alternately, select the present value on the sequence table, right-click, and select **Edit Data – Element**.

Action Validation on Element Screen

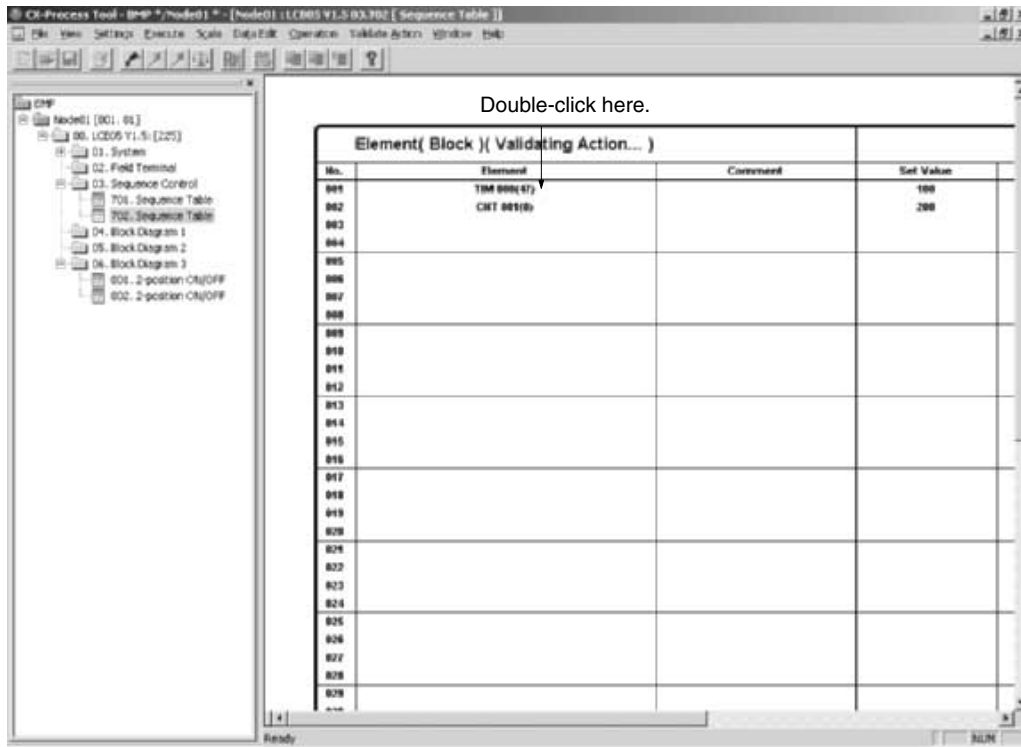

Action Validation on Sequence Table Screen

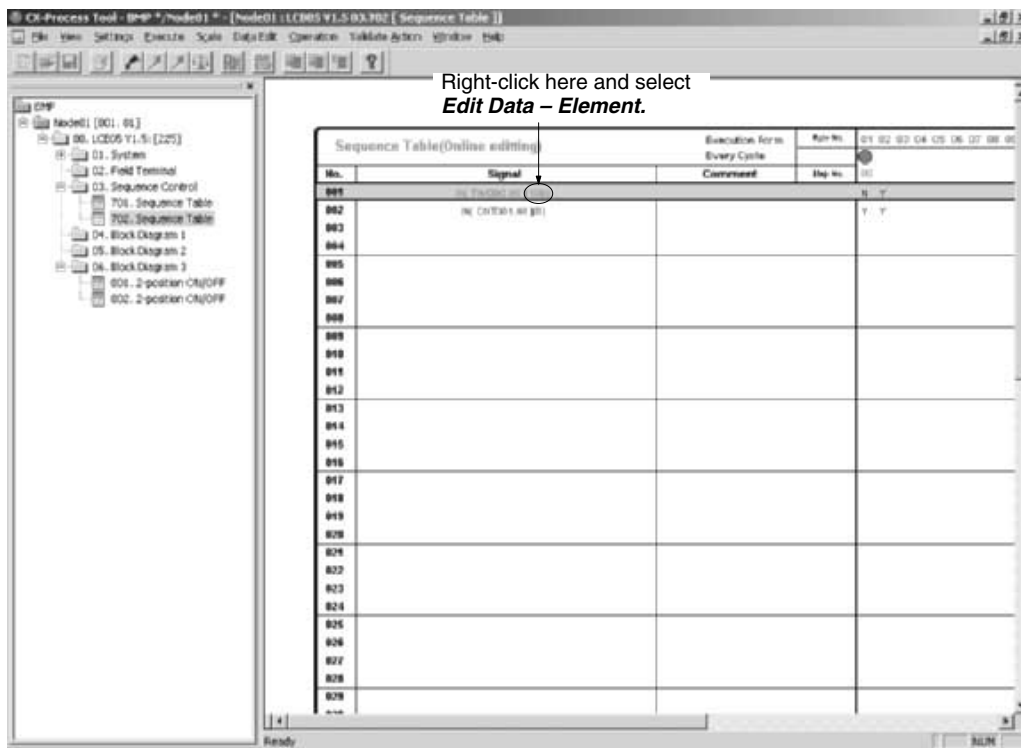

- The Element Initial Data Setting Dialog Box will be displayed. Change the set value or pre-alarm value in this dialog box.

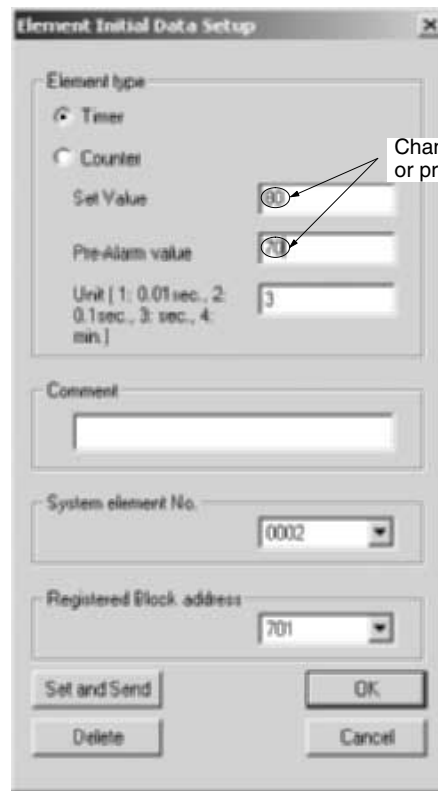

- After changing the set value or pre-alarm value, click the **Set and Transfer** Button. As shown below, the set value of the element will change during operation.

Action Validation on Element Screen

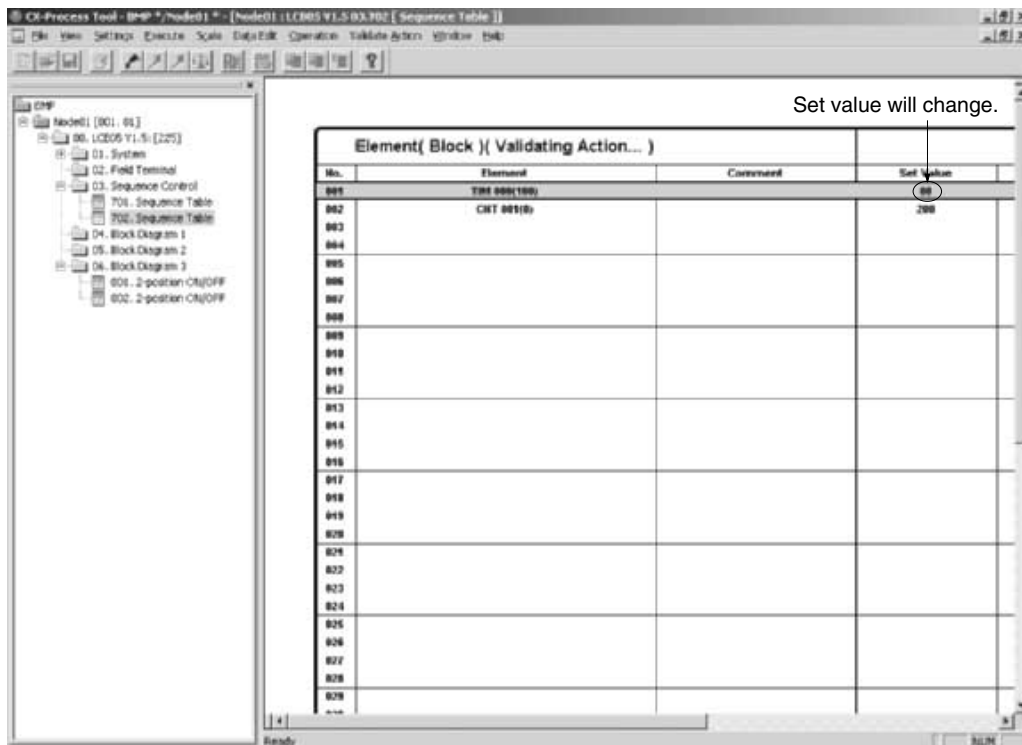

Note The following cannot be changed for elements.

- The time unit for a timer element
- Changing a previously registered timer to a counter or a previously registered counter to a time.

Adding Elements (Possible on Element Display Screen Only)

An element can be added while the Loop Controller and sequence table are operating.

- 1, 2, 3... 1. Double-click an unused element row.

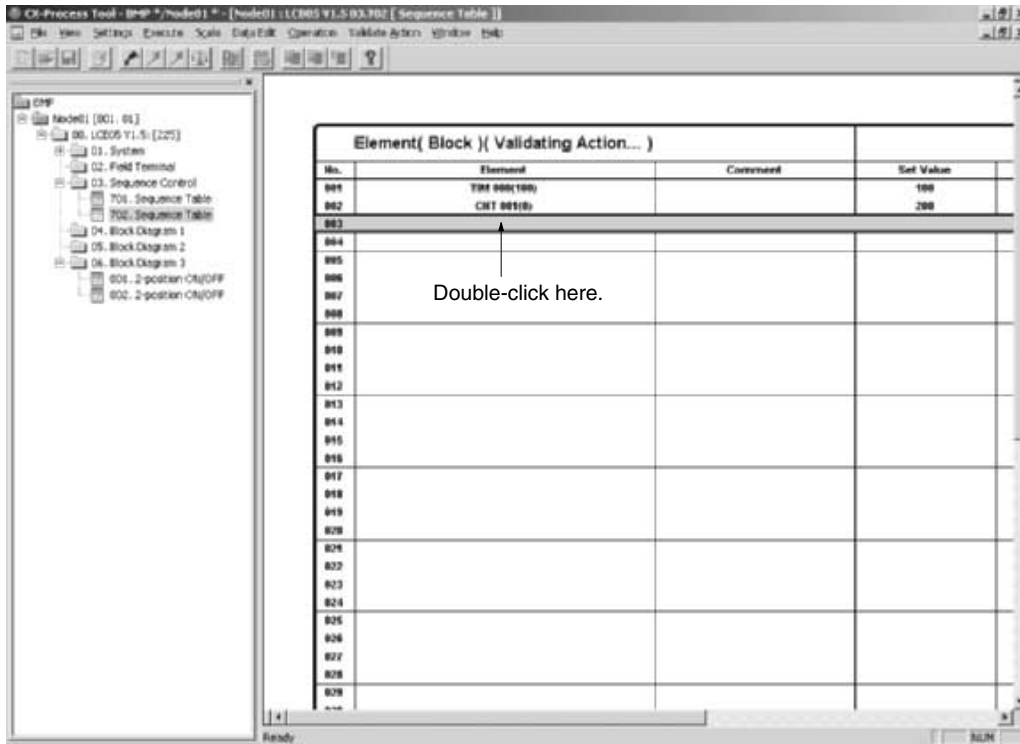

- The following dialog box will be displayed. Select the new element (timer or counter) to be added.

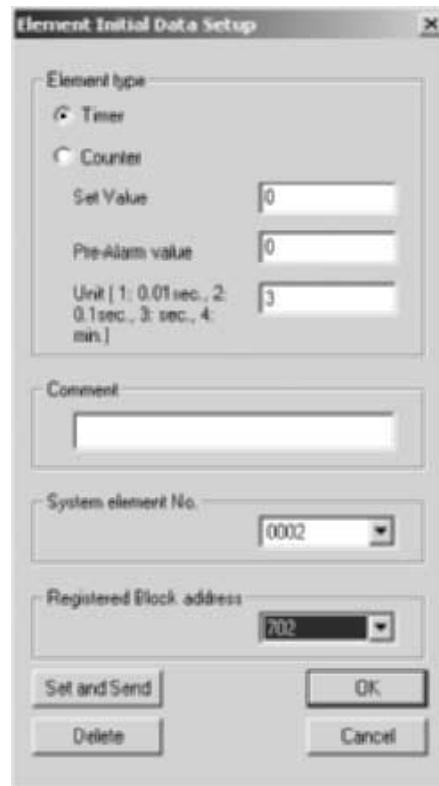

The dialog box is titled "Element Initial Data Setup" and contains the following fields and controls:

- Element type:** Radio buttons for "Timer" (selected) and "Counter".
- Set Value:** Text input field containing "0".
- Pre-Alarm value:** Text input field containing "0".
- Unit:** Text input field containing "3". Below the field is a legend: "Unit | 1: 0.01sec., 2: 0.1sec., 3: sec., 4: min.".
- Comment:** Empty text input field.
- System element No.:** Dropdown menu showing "0002".
- Registered Block address:** Dropdown menu showing "702".
- Buttons:** "Set and Send", "Delete", "OK", and "Cancel".

- After adding the element, click the **Set and Transfer** Button.

Deleting Elements (Possible on Element Display Screen Only)

An element can be deleted while the Loop Controller and sequence table are operating.

- 1, 2, 3... 1. Double-click the element to be deleted.

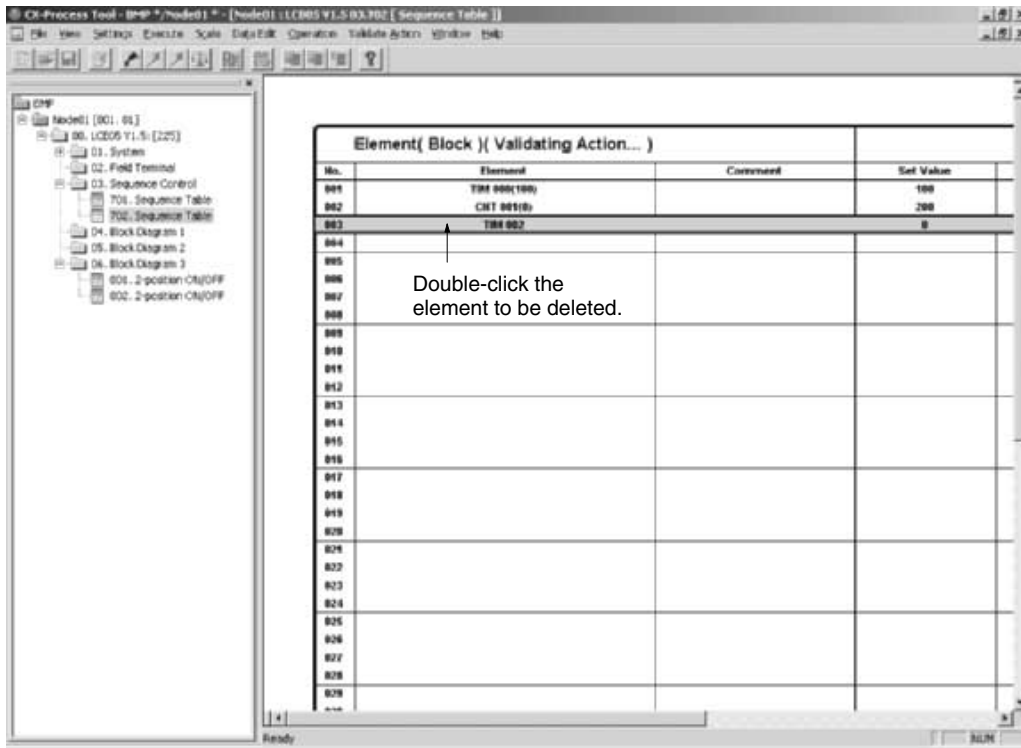

2. The following dialog box will be displayed. Click the **Delete** Button.

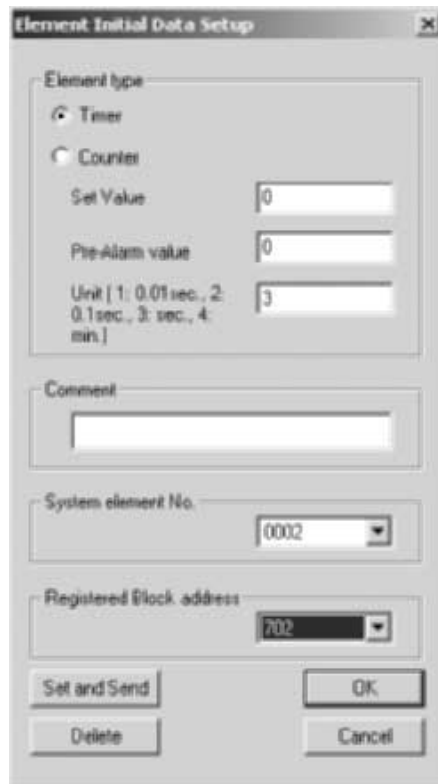

4-7 Tuning

PID constants, SPs, and other settings listed below can be changed online.

- Parameters such as the PID Block's P, I, and D constants, and the alarm set values can be set.
- The PV, SP, and MV trends can be adjusted while monitoring.
- If an alarm occurs, the bar graph color changes.

With CX-Process Tool version 3.2 or higher, specified ITEMS in function blocks being displayed on Tuning Screens can be logged and output to CSV files.

4-7-1 Switching to the Tuning Screen

Use the following procedure.

- 1, 2, 3... 1. Select the function block to be tuned and select **Monitor/Tuning Screen** from the Execution menu.
2. The Tuning Screen Configuration Dialog Box will be displayed.

Note This dialog box resembles the dialog used to set monitor tags. (Displayed by selecting **Monitor Tags** from the Settings menu.)

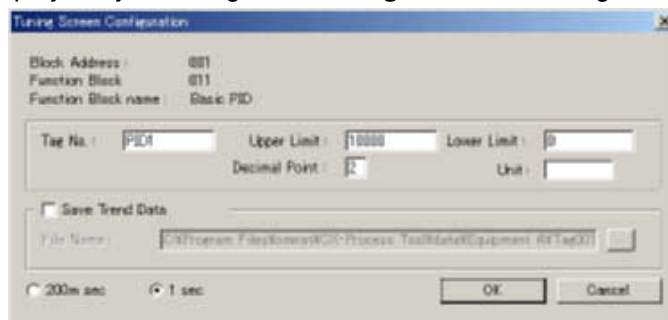

Use this dialog box to input settings for the function block, including the Tag name, Scaling range (Scaling Upper Limit and Scaling Lower Limit), Decimal Point, and Unit. (See note a.) After inputting the desired values, click the **OK** Button.

With version 3.0 or higher of the CX-Process Tool, the monitoring cycle for data (such as PVs, SPs, and alarms) on the Tuning Screens can be set to 1 s or 200 ms. (With unit Ver. 2.5, the cycle was fixed at 1 s.) (See notes b and c.) Select either 1 s or 200 ms before clicking the OK Button.

If the data cannot be refreshed for the specified cycle, a warning will be displayed in red to indicate that the monitoring cycle is longer than the specified value as follows:

Blue: The cycle is within the specified value (1 s or 200 ms).

Red: The cycle is not within the specified value (1 s or 200 ms).

Note a) The Scaling range (upper limit and lower limit), Decimal point position, and Units settings apply to all of the function block's SP and PV values.

b) This setting is also used for the data logging cycle.

c) Setting the data monitoring cycle to 200 ms does not necessarily mean that the refresh cycle will be 200 ms because the load on the computer and other factors will affect it. Use this setting as a guideline only.

- With CX-Process Tool version 3.2 or higher, operation can be set so that data logging for specific ITEMS (such as the PV, SP, and MV) is started when a Tuning Screen is opened and then the logged data is saved in an CSV file when the Tuning Screen is closed. The data logging cycle is the same as the data monitoring cycle (either 200 ms or 1 s).

- Select the *Save Trend Data* to log data and save it in a CSV file. The default location for the CSV file is in the current directory with a file name of *CSVTagNameInFunctionBlock_PresentTime.csv*. The present time is in the form YYYY/MM/DD_HH/MM/SS. Click the **Browse** Button to change the storage location.

3. The Tuning Screen will be displayed. The following settings can be displayed and set.

| Block name (model) | Signal source Function Block or ITEM |
|---|--|
| Target function block | Control Block: Basic PID (011), Advanced PID (012), Batch flowrate capture (014), Indication and Setting (031), Indication and Operation (032), Ratio Setting (033), Indicator (034), blended PID (013), 2-position ON/OFF (001), 3-position ON/OFF (002), Segment Program 2 (157) |
| Display Example: Basic or Advanced PID | SP, PV, and MV trends Setting values for P, I, D, and MV limit High/Low, High/High Alarm, High Alarm, Low Alarm, Low/Low Alarm, and Deviation Alarm. Alarm OFF switch, Stop block operation command, SP, PV, MV, and A/M status, R/L status (See note 1.), bar color change if alarm occurs. |
| Settings Example: Basic or Advanced PID | Setting values for P, I, D, and MV limit High/Low, High/High Alarm, High Alarm, Low Alarm, Low/Low Alarm, and Deviation Alarm. SP, MV (manual mode only), A/M switching (See note 1.), R/L switching (See note 1). |

Note Refer to *4-7-3 Screen Configuration* below for details on the screen configurations and setting procedures.

4. To close the Tuning Screen, click the **X** Button in the upper-right corner of the window. If data logging is being performed at the time, the logging file will be saved when the Tuning Screen is closed.

Note With CX-Process Tool version 3.2 or higher, up to four Tuning Screens can be opened at the same time. Opening more Tuning Screens, however, will increase the communications load and can cause large errors in the data monitoring/logging refresh cycle.

4-7-2 Data Logging on Tuning Screens

Starting Logging

Data logging is started when the Tuning Screen is opened.

Logged Data

The following ITEM data is logged for each function block in the Tuning Screen.

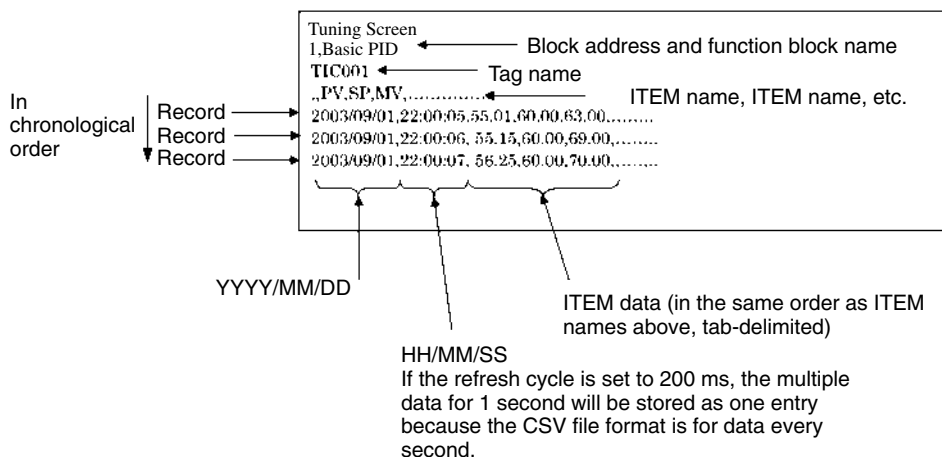

CSV File Format

Data is saved in the following format.

| Function block | ITEMs output to CSV file as logged data |
|--|---|
| 2-position ON/OFF (Block Model 001) | PV, SP, MV |
| 3-position ON/OFF (Block Model 002) | PV, SP, MVH, MVL |
| Basic PID (Block Model 011) | PV, SP, MV |
| Advanced PID (Block Model 012) | PV, SP, MV |
| Blended PID (Block Model 013) | Y1, Y2, MV |
| Batch Flowrate Capture (Block Model 014) | Y1, MV |
| Fuzzy Logic (Block Model 016) | X1, X2, X3, X4, X5, X6, X7, X8, Y1, Y2 |
| Indication and Setting (Block Model 031) | PV, SP |
| Indication and Operation (Block Model 032) | PV, MV |
| Ratio Setting (Block Model 033) | PV, SP, MV |
| Indicator (Block Model 034) | PV |
| Segment Program 2 (Block Model 157) | X1, Y1 |

Number of Records

When the maximum of 65,500 records is reached, the message will be displayed and the Tuning Screen will be ended automatically.

Data Logging Cycle

The data logging cycle is 1 s or 200 ms. (Set *200 msec* or *1 sec* in the Tuning Screen Setting Dialog Box.)

Note Setting the data logging cycle to 200 ms does not necessarily mean that the refresh cycle will be 200 ms because the load on the computer and other factors will affect it. Use this setting as a guideline only. If the refresh cycle is set to 200 ms, the multiple data for 1 second will be stored as one entry because the CSV file format is for data every second.

4-7-3 Screen Configuration

Click the text to display the dialog boxes used to change the settings. Make changes using the ten-key dialog box (using the mouse), or the keyboard.

Monitoring Cycle Status

Blue: Cycle is within specified value (1 s or 200 ms).

Red: Cycle is not within specified value (1 s or 200 ms).

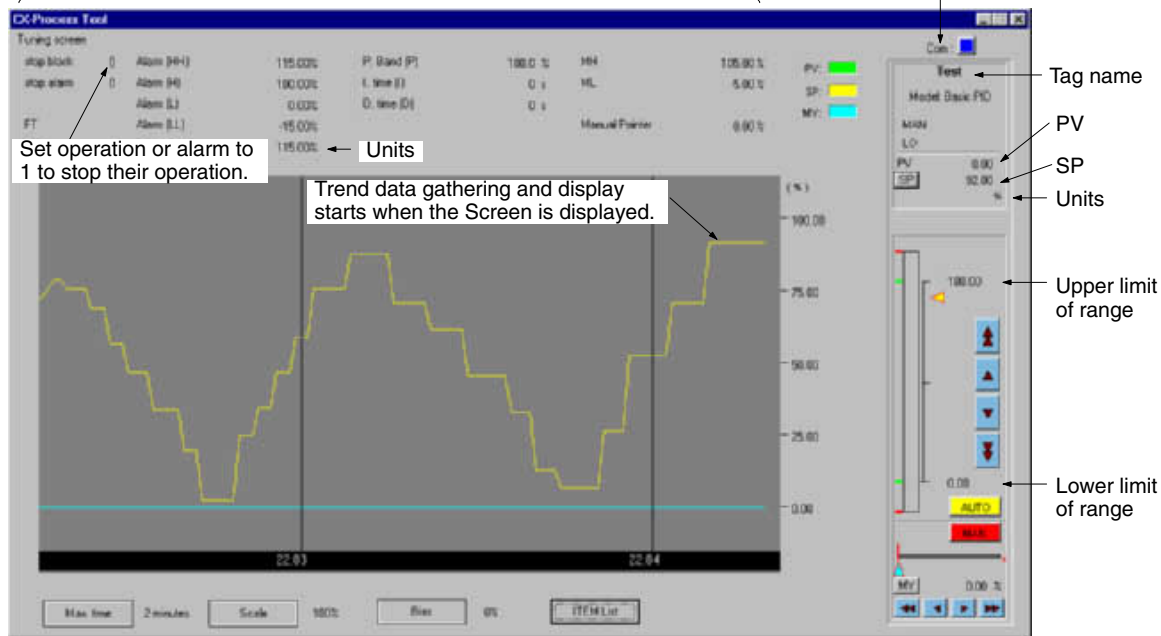

Select these buttons to display the dialog boxes for changing the settings.

Face plate control for the selected function block. (See 4-7-4 Face Plate Controls for details.)

- The face plate control for the selected function block will be displayed on the right side of the window. The trend chart for the function block's SP, PV, and MV values will be displayed on the left side of the window.
- The face plate control will display the Scaling range (upper limit and lower limit), Decimal point position, and Units that were set in the Tuning Screen Configuration Dialog Box.
- The trend chart displays the SP and PV values after scaling the Y-axis values, but the MV chart is displayed in full scale with a lower limit of 0% and upper limit of 100%.
- The function block's tag name (set in the Tuning Screen Settings Dialog Box) will be displayed at the top of the function block's face plate control.
- The accumulation of trend data starts when the Tuning Screen is opened and is displayed only while the Tuning Screen is displayed.
- Click the **Time Range** Button to set the width of the time axis displayed on the screen.
- To zoom in on the scale displayed, click the **Scale** Button and change the setting.
- To add bias to the display, click the **Bias** Button and change the setting.
- Click the **ITEM List** Button to reference an offline ITEM setting list. (The list will be displayed behind the Tuning Screen.)

4-7-4 Face Plate Controls

This section describes the contents of the face plate controls that are displayed on the right side of the Tuning Screen.

Basic PID (011)

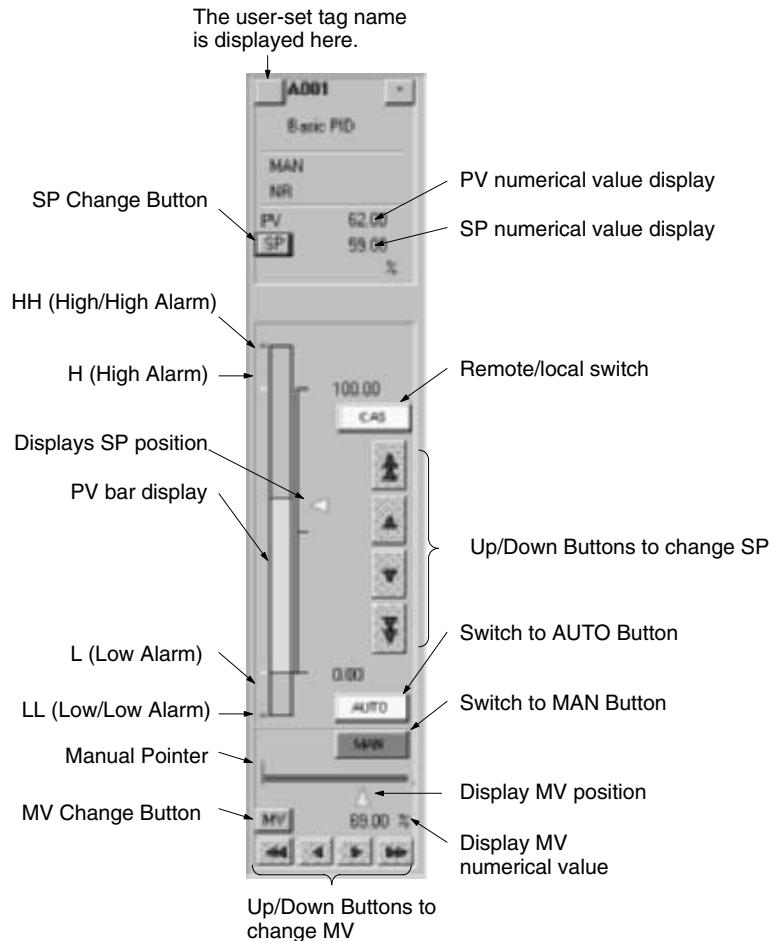

PV Bar Display

Displays a bar between the upper and lower limits of the PV range.

- Green: Status normal
- Red: PV Alarm (either HH, H, L, LL) occurred
- Yellow: Deviation Alarm occurred
- Blue: Alarm OFF
- Light blue: Function block calculations stopped

Changing the SP

Change SP using the SP Change Up/Down Buttons.

First press the **SP** Button, click the value column, and then change the SP using the ten-key dialog (using the mouse), or the keyboard. (The ten-key pad is displayed when the input box is selected. To enable inputting from the ten-key, click the **System Info** Button in the Setup Dialog Box, and then change the setting to enable the ten-key.

Changing the MV

Change the MP using the MP Change Up/Down Buttons.

First press the **MP** Button, and then enter the change using the ten-key dialog box (using the mouse), or the keyboard.

Remote/Local (R/L) Switching

When the SP setting (local only, or remote/local both possible) for ITEM024 for Basic PID, Advanced PID, Indication and Setting, Ratio Setting, 2-position ON/OFF, and 3-position ON/OFF is 1 (remote/local both possible), CAS is displayed.

When the **CAS** Button is red, the setting is on remote SP. When the **CAS** Button is blue, the setting is on local SP. Click the **CAS** Button to switch the setting.

Note When the CX-Process Monitor is set to Remote SP, A/M automatically switches to AUTO. You cannot set Manual.

A/M Switching

When AUTO is lit red, the setting is AUTO. You can change the SP value. When MAN is lit blue, the setting is manual. You can change MV and SP values. Select AUTO or MAN to switch.

MV Adjustment Area Details

The MV Adjustment Area is displayed for the following function blocks: Basic PID (011), Advanced PID (012), Batch Flowrate Capture (014), Indication and Operation (032), and Ratio Setting (033)

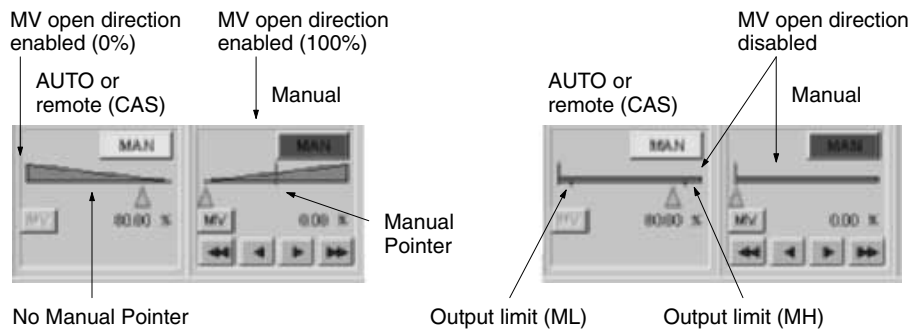

Make Manual Pointer and MV open direction settings when registering the Control Screen.

Make output limit (ML, MH) settings using the Tuning Screen.

2-position ON/OFF (001)

3-position ON/OFF (002)

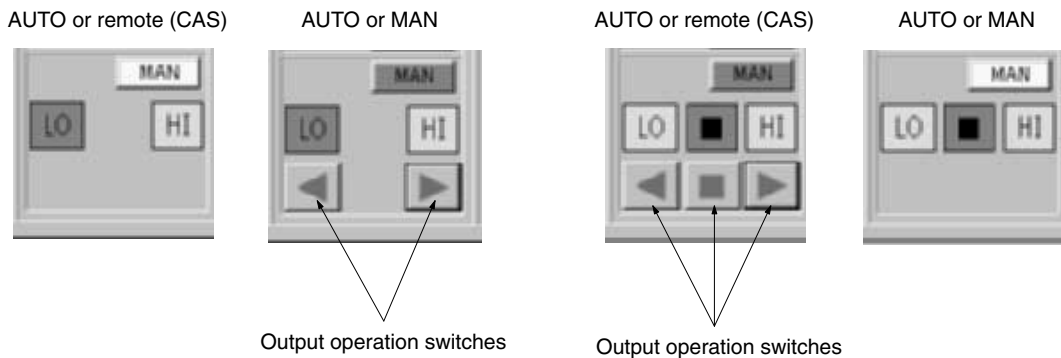

Face Plate Control Examples

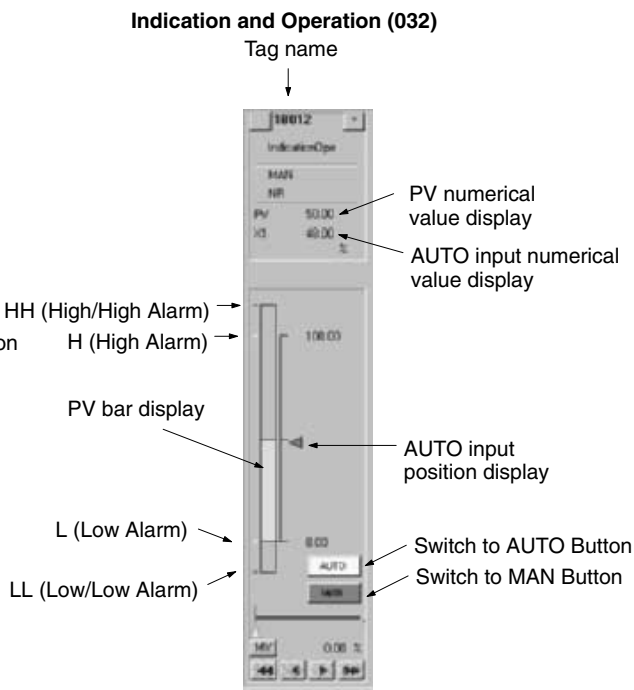
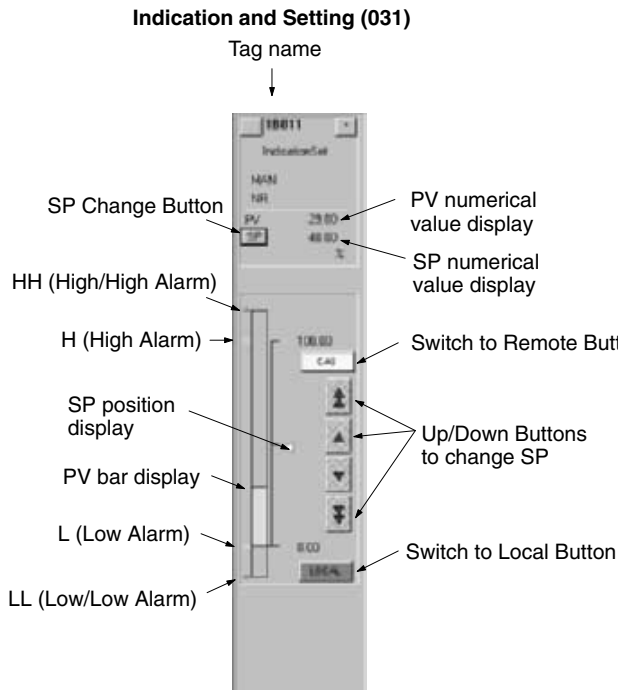

PV Bar Display

This bar shows the PV range (lower limit to upper limit).

Green: Status normal

Red: PV Alarm (either HH, H, L, LL) occurred

Blue: Alarm OFF

Light blue: Function block calculations stopped

PV Bar Display

This bar shows the PV range (lower limit to upper limit).

Green: Status normal

Red: PV Alarm (either HH, H, L, LL) occurred

Blue: Alarm OFF

Light blue: Function block calculations stopped

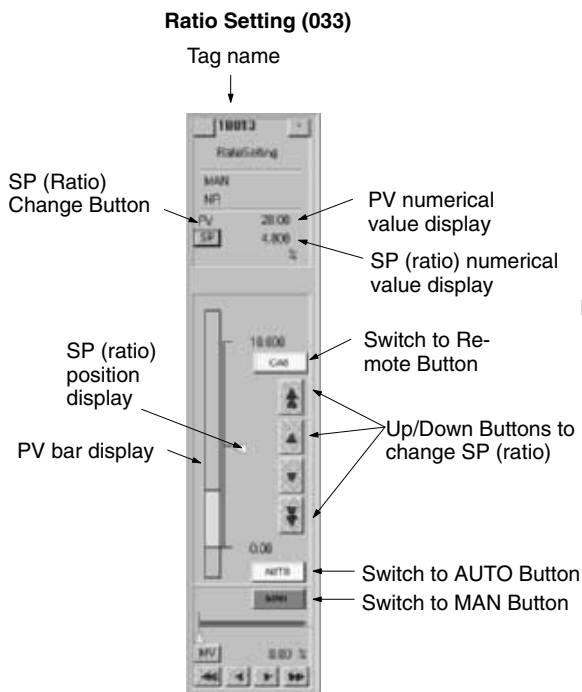

PV Bar Display

This bar shows the PV range (lower limit to upper limit).

Green: Status normal

Red: PV Alarm (either HH, H, L, LL) occurred

Blue: Alarm OFF

Light blue: Function block calculations stopped

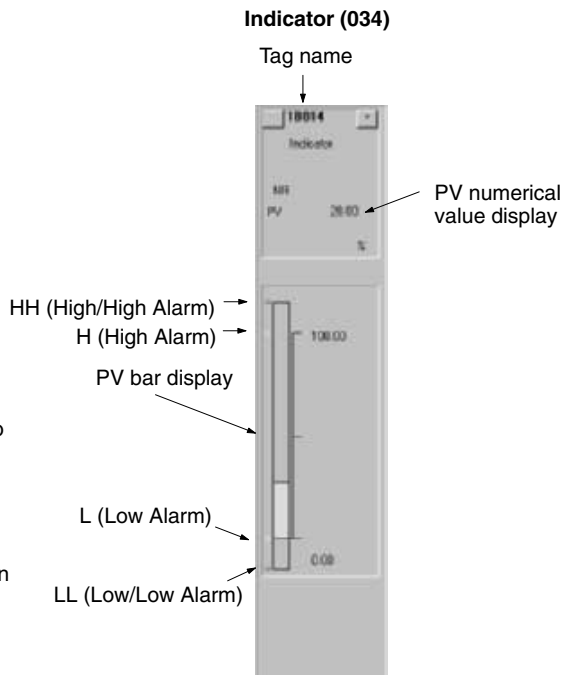

PV Bar Display

This bar shows the PV range (lower limit to upper limit).

Green: Status normal

Red: PV Alarm (either HH, H, L, LL) occurred

Blue: Alarm OFF

Light blue: Function block calculations stopped

Batch Flowrate Capture (014)

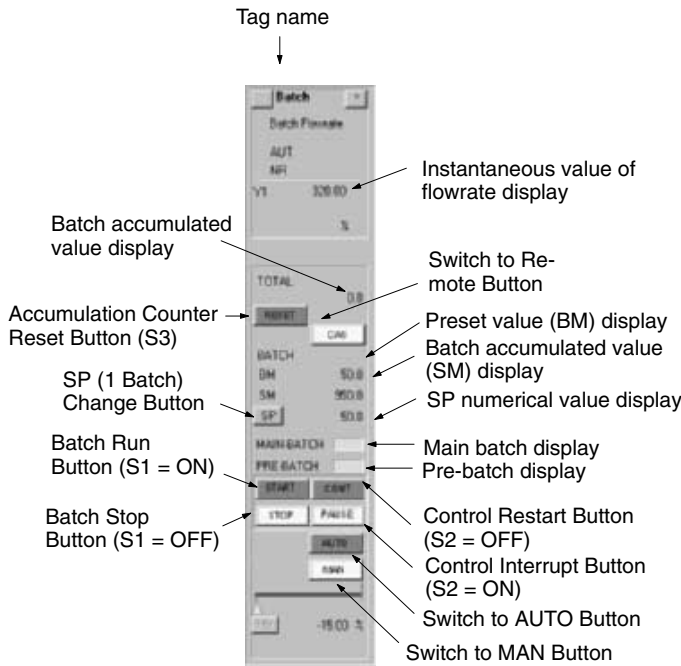

Blended PID (013)

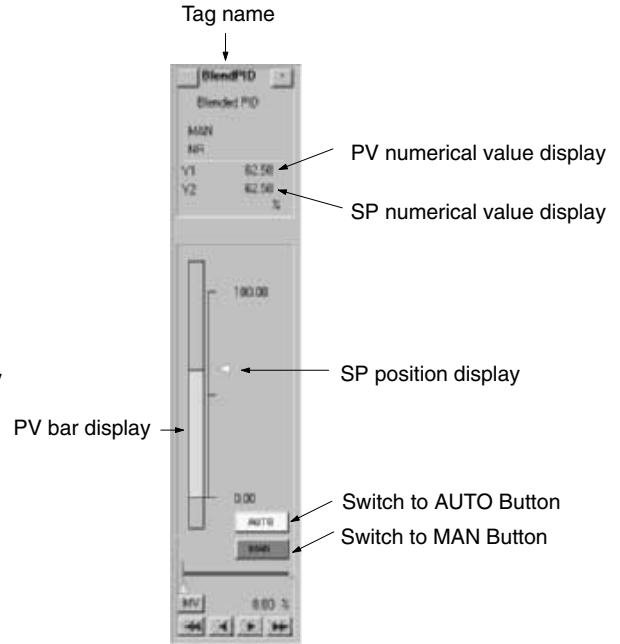

PV Bar Display

This bar shows the PV range (lower limit to upper limit).
 Green: Status normal
 Red: Deviation Alarm (DHH, DH, DL, or DLL) occurred
 Yellow: MV Limit High/Low
 Blue: Alarm OFF
 Light blue: Function block calculations stopped

Fuzzy Logic (016)

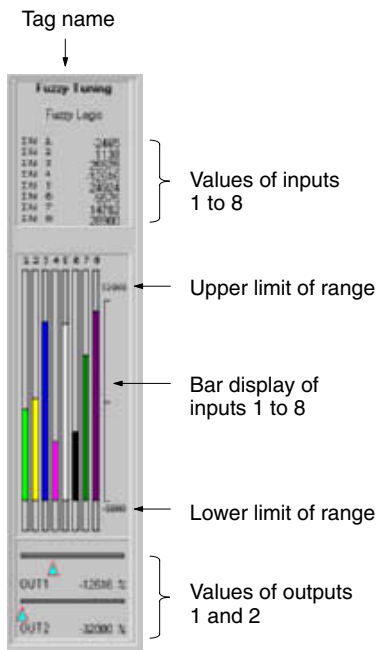

Segment Program 2 (157)

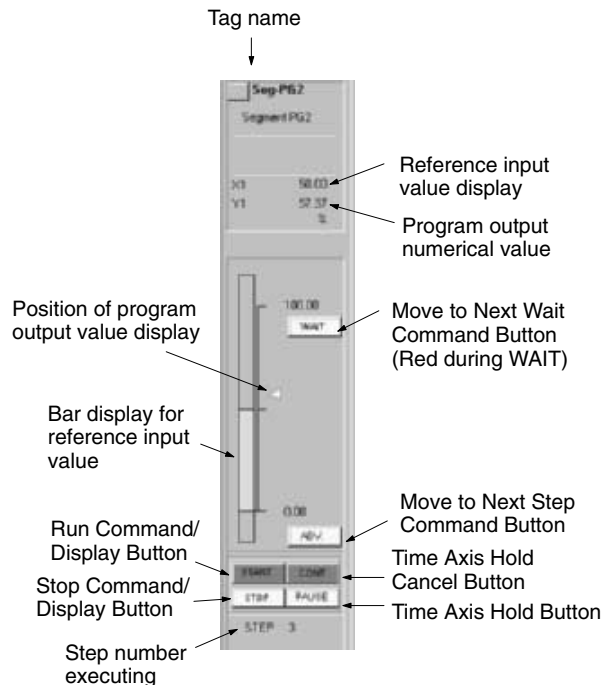

Bar Display of Inputs 1 to 8

These bars show values of inputs 1 to 8 within their range (lower limit to upper limit). The bars are displayed in different colors to distinguish the bars.

4-7-5 Operation Procedures

Auto-tuning (AT)

It is possible to automatically calculate and store the PID constants used for Basic PID (011) or Advanced PID (012). This function is called auto-tuning (AT). For details of the AT function, refer to the section on Basic PID (011) in the *Function Block Reference Manual* for the Loop Controller (Loop Control Units: W375, LCB□□s: W407). AT can be set in the same way as the other settings, as shown below.

- 1, 2, 3... 1. If the value for AT displayed in the upper-left region of the Tuning Screen is 0, then AT is not being executed.
2. Click **AT**.
The Change Data Dialog Box shown below will be displayed.

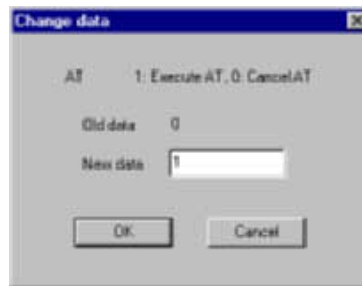

3. To execute AT, input 1 in the New Data Field.
4. Click the **OK** Button. AT will be executed (see note). The value for AT displayed in the upper-left region of the Tuning Screen will change to 1.
5. When the PID constants have been calculated and stored and AT has been completed, the value for AT displayed in the upper-left region of the Tuning Screen will return to 0.

Note Execution of AT can be cancelled from the above dialog box by inputting 0 in the New Data Field and clicking the **OK** Button. (The value for AT displayed in the upper-left region of the Tuning Screen will return to 0.)

Changing P, I, and D

The following example shows how to change P (the proportional band).

- 1, 2, 3... 1. Click **Proportional Band (P)** displayed in the upper center of the screen.
The Change Data Dialog Box will be displayed.

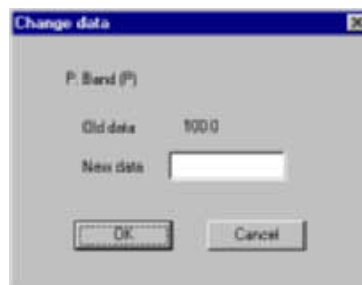

2. Click the "New data" input field.

The Input Data Dialog Box (ten-key) will be displayed as shown.



3. After using the mouse (or the keyboard) to enter a numerical value, click the **OK** Button or press the **Enter** Key.

The display will return to the Change Data Dialog Box shown in Step 1.

4. Click the **OK** Button.

The settings for I (integral time) and D (differential time) can be changed in the same way.

Changing Other Settings

You can use the procedure explained above to change the settings for MV High/Low Limit, High/High Alarm, High Alarm, Low/Low Alarm, Low Alarm, and Deviation Alarm in the same way.

Executing Fine Tuning

Fine tuning (FT) can be executed for either Basic PID (011) or Advanced PID (012). Fine tuning lets the user use fuzzy logic to set PID constants as required for more accurate control.

- 1, 2, 3... 1. Click **Execute FT** at the upper left portion of the Tuning Screen, as shown below.

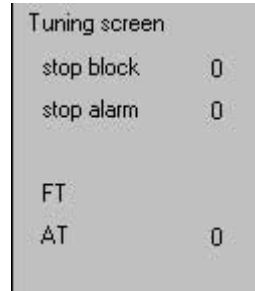

The following Execute FT Dialog Box will be displayed.

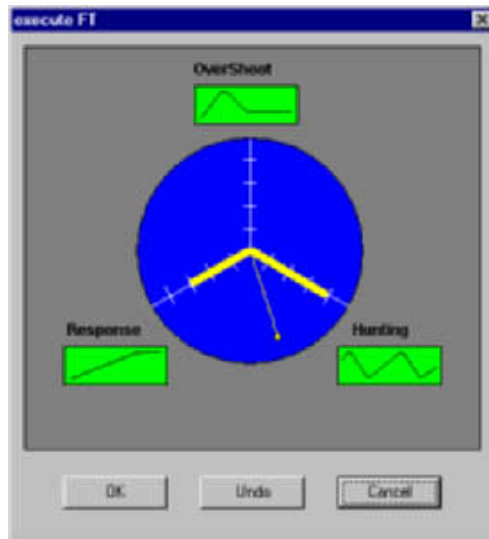

- Set the degree of **Response** improvement, **Overshooting** control, and **Hunting** control to any of the five levels and then click the **OK** Button.

Note Fine tuning will be executed with the settings in the FT Execution Dialog Box each time that the **OK** Button is clicked. The **Undo** Button can be clicked to return to the previous PID constant settings. (The previous PID constant settings will be restored if the Undo Button is pressed a second time.)

- Fine tuning will be executed according to the settings that were input.
- The PID constants adjusted with fine tuning will be stored automatically and the new values will be displayed at the top of the Tuning Screen. The proportional band, integral time, and derivative time settings will change.

Execute fine tuning when the control performance produced by autotuning is not acceptable, when autotuning produces instability in the PV, or when you cannot allow control to be interrupted.

Fine tuning improves control by automatically setting PID parameters using the three user settings listed below along with fuzzy logic applied to previous control conditions.

- Hunting
- Overshooting
- Responsiveness

Either one or two of the user setting can be set to any of five adjustment levels. For example, to better control hunting and overshooting, the *Overshoot* and *Hunting* parameters can be set to the desired levels.

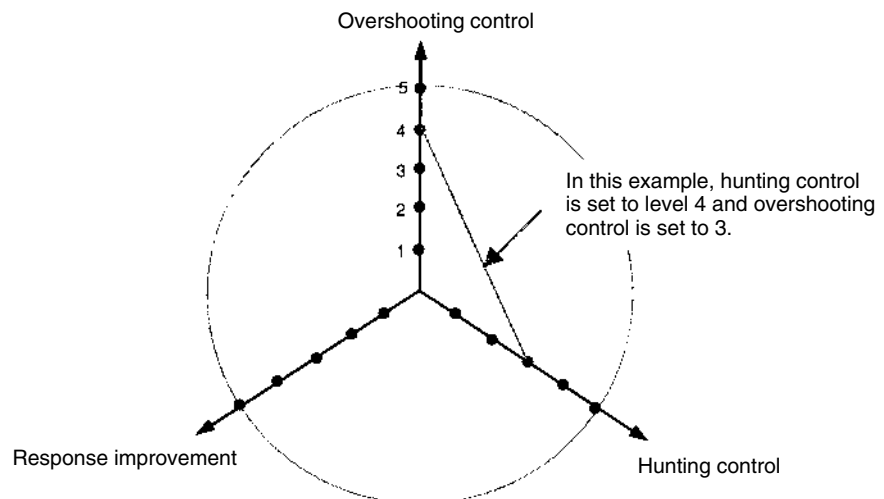

Checking the Fuzzy Logic Block (016) Membership Function

When the fuzzy logic block (016) is being tuned, the display will show the Membership Function (MF) set with ITEMS in the Tuning Screen.

The Membership Function can be checked for each label (NL, NS, ZR, PS, and PL) of inputs 1 to 8.

- 1, 2, 3... 1. Click on **Check MF** Button in the upper-left corner of the Tuning Screen. The Input Selection Dialog Box will be displayed.

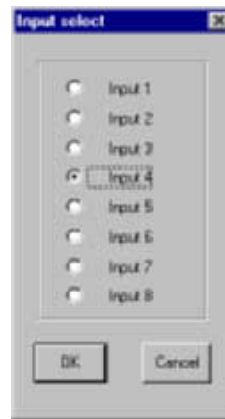

2. Select an input (Input 1 to 8) and click the **OK** Button.
The following Confirm MF Dialog will be displayed. Each label (NL, NS, ZR, PS, and PL) will be displayed in a different color and the graph will show the output levels (Y-axis) corresponding to the input values (X-axis).



4-8 Backup and Recovery

The function block data in RAM in the Loop Controller can be backed up in flash memory in the Loop Controller and the data in flash memory can be restored to RAM.

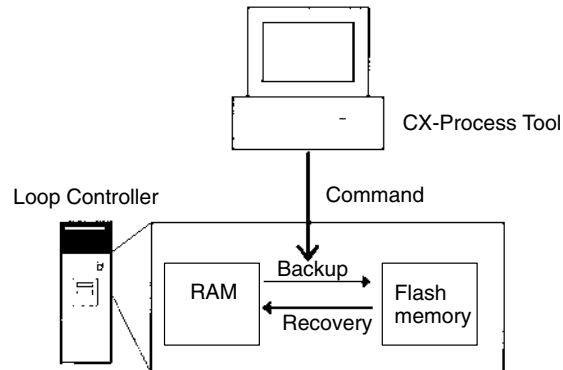

Note With the LCB02/05 unit Ver. 1.50 or later, the LCB05D, or LCB03, data can be backed up while continuing operation. With other models, stop Loop Controller operation before performing backup.

4-8-1 Backup Procedure

Backing Up Data Directly to Flash Memory Using Menus

- 1, 2, 3... 1. Select an LCU/LCB element.
2. Select **Backup Data Operation – Backup** from the Execute Menu.

Backing Up LCU/LCB Element or Function Block Data to Flash Memory after Download

- 1, 2, 3... 1. Select an LCU/LCB element or function block.
2. Select **Transfer to LC** from the Execute Menu.
3. The Transfer Dialog Box (shown below) will be displayed. Select the **LCB back up indication after transfer** option.



4. Click the **Start** Button.

Note With the LCB01/05 unit Ver. 1.50 or later, LCB05D or LCB03, if backup is performed during operation, data is backed up without stopping operation. When performing backup during operation, note the following points.

- The CPU Unit's cycle time may increase by approximately 10 ms.
- It may take up to 10 minutes for backup processing to be completed.

- If the stop command is executed during backup processing, operation will stop but backup processing will continue.
- If backup is attempted before processing for a previous backup operation is started, the latter backup operation will be invalidated. Perform backup again once backup processing has been completed.
- The following operations are not possible during backup processing. “Now executing back up operation. Stop processing” will be displayed if an attempt is made.
 1. Main Screen (Including Pop-up Menus)
 - *Settings – Program Protection – Edit LCB Password*
 - *Execute – Delete Registration Function Block – Delete*
 - *Execute – Transfer to LC – FBD Information*
 - “Reset the load rate” under *Execute – Operation – Monitor Run Status* (Set the ITEM displayed as “Reset” to 0.)
 - *Execute – Operation – RUN/Stop Command – HOT START (or COLD START)* (Here, an error code of 110C will be generated.)
 2. User Link Table Pop-up Menu
 - *Transfer to LC – Selected Entries*
 - *Transfer to LC – All Entries*
 3. Edit Block Diagram Mode Menus (Including Pop-up Menus)
 - *Manipulate FBD – Setting Block Operation Cycle – Transfer to LC*
 4. Downloading the System Common Block when transferring individual ITEM data settings
 5. Transferring LCU/LCB folder or function block groups
 6. Executing the *Clear All* operation
 7. Executing the *Recovery* operation

Note If the power supply is interrupted while backup is being performed during operation, backup processing will be automatically re-attempted after the power supply is restored. In this case, backup will be performed with the Loop Controller operation in the stopped state. (With the CS1D-CPU□□P, CPU Unit operation will also stop.)

4-8-2 Recovery Procedure

- 1, 2, 3... 1. Select an LCU/LCB element.
2. Select **Backup Data Operation – Recovery** from the Execute Menu.

Note For a Loop Control Unit, the contents of flash memory will be automatically transferred to RAM at startup if pin 2 of the DIP switch on the front of the Loop Control Unit is turned ON. (This function is used to enable battery-free operation.) The basic procedure is as follows:

- a) Execute **Backup Data Operation – Backup** from the Execute Menu.
- b) Turn OFF the power supply to the PLC.
- c) Turn ON pin 2 of the DIP switch on the front of the Loop Control Unit.
- d) Turn ON the power supply to the PLC.

For an LCB□□, the contents of flash memory will be automatically transferred to RAM at the following times.

- When a cold start operation command is given
- When a RAM error (data lost) occurs when power is turned ON, causing a cold start
- When ITEM 101 (backup start command) in the System Common block is ON and a flash memory error occurs but RAM is normal when power is turned ON (RAM data will automatically be backed up to the flash memory first and then a cold start will be implemented automatically.)

The contents of flash memory can also be transferred to RAM as required by executing ***Backup Data Operation – Recover*** from the Execution Menu. An all clear operation is performed before the data is transferred.

4-9 Transferring Tag and Comment Data

When CX-Process Tool Ver. 4.0 or higher is used, block diagram data, tags, comments, and annotations that do not directly affect control can be stored (i.e., transferred) in flash memory in the Loop Control Board or on a flash Memory Card installed in the CPU Unit.

This enables function block data, including tags, comments, annotations, and connection data from the Loop Controller to be uploaded (recovered).

Data Saved in Flash Memory

The following data can be transferred and recovered using flash memory. This data is treated as additional data that does not directly affect control of the Loop Controller.

| Type | Contents |
|-----------------|---|
| Block diagram | Block diagram line data, annotation data |
| CSV tags | Tag names, tag comments, scaling upper/lower limits, decimal positions, and units |
| User Link Table | Tag names and comments |
| Step ladder | Output contact comments (STEP, BR, BS, JUMP, OT, TN, DU, DD), annotation data |
| Sequence table | Signal comment (conditions, actions), element comments (timers, counters) |

Flash Memory Types

The type of flash memory supported depends on the Loop Control Board version. The following are the types of flash memory for the transfer destination, which depend on the combination of the Loop Control Board version and the CX-Process version.

| | CX-Process Ver. 5.0 | CX-Process Ver. 4□ |
|--------------------------------|-------------------------------------|------------------------------|
| LCB Ver. 3.0 | Inner flash memory (See note 1.) | Memory Card (See note 2.) |
| LCB Ver. 2.0 or earlier | Memory card (See note 2.) | Memory Card (See note 2.) |

- Note**
1. Transfer cannot be performed to the Memory Card.
 2. Transfer cannot be performed to the inner flash memory.

Method for Transferring and Recovering to Inner Flash Memory

Transfer or recovery to the inner flash memory will be performed by executing the following operations.

Transfer to Inner Flash Memory

Download LCU/LCB elements (select ***Transfer to LC – Selected***) or transfer data to the inner flash memory (select ***Transfer to LC***).

Recover to Inner Flash Memory

New upload (***Transfer from LC – New***)

Transferring and Recovering to a Memory Card

The Memory Card backup/recovery functions automatically when the following operations are performed with the Memory Card installed in the CPU Unit.

Backup to the Memory Card:

Downloading LCU/LCB elements or transferring data to a Memory Card

Recovery from the Memory Card:

Performing new uploads (***Transfer from LC – New***)

4-9-1 Backing Up Data to the Memory Card

Transfer to flash memory can be performed when LCU/LCB elements are downloaded or when a data transfer is performed to a Memory Card.

Inner Flash Memory

Downloading LCU/LCB Elements

- 1, 2, 3...**
1. Select the LCU/LCB elements in the Project Workspace.

2. Download the LCU/LCB elements.
3. Click the **Start** Button and data will automatically be transferred to the inner flash memory after the function block data is transferred.

Data Transfer to Inner Flash Memory

- 1, 2, 3...**
1. Select **Transfer to LC - Transfer tag info** from the Execute Menu. Data will be transferred to the inner flash memory.

Note The following dialog box will be displayed when the functions groups have been downloaded.

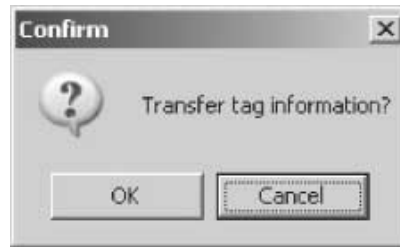

Note To download functions after adding or deleting function blocks be sure to click the OK Button to transfer the tag information to the internal flash memory. If the tag information is not transferred to the internal flash memory, block diagrams will become corrupted when a new upload is performed and may be deleted.

Memory Card

Downloading LCU/LCB Elements

- 1, 2, 3...**
1. Select the LCU/LCB element in the Project Workspace Area.
 2. Download the LCU/LCB element.
 3. The following dialog box will be displayed.



4. Click the **Option** Button and make sure that the **Transfer data to Memory Card** option is selected. This option is normally selected by default when the Memory Card is installed.
5. Click the **Start** Button. Function block data will be automatically transferred to the Memory Card after being downloaded.

Transferring Data to the Memory Card

Select **Transfer to LC – Memory Card** from the Execution Menu to transfer data to the Memory Card.

Note If Memory Card backup is not required when the Memory Card is installed, disable the option to transfer data from the Memory Card.

4-9-2 Recovering Data from the Memory Card

Inner Flash Memory

Recovery of data from inner flash memory can be performed only when performing a new upload.

- 1, 2, 3... 1. Select the LCU/LCB element in the Project Workspace Area.
2. Perform a new upload.
3. Click the **Start** Button and data will automatically be transferred to the inner flash memory after the function block data is transferred.

Memory Card

Recovery of data from a Memory Card can be performed only when a new upload is performed. Use the following procedure.

- 1, 2, 3... 1. Select the LCU/LCB element in the Project Workspace Area.
2. Perform a new upload.
3. The following dialog box will be displayed.



4. Click the **Option** Button and check that the *Transfer data from Memory Card* option is selected. This option is normally selected by default when the Memory Card is installed.
5. Click the **Start** Button. Function block data will be automatically transferred from the Memory Card after being downloaded.

- Note**
1. If Memory Card backup is not required when the Memory Card is installed, disable the option to transfer data from the Memory Card.
 2. Use an OMRON Memory Card. Operations may be unstable if a non-OMRON Memory Card (compact flash memory) is used.

| File memory | Memory type | Memory capacity | Model |
|---|--------------|-----------------|-----------|
|  | Flash memory | 15 Mbytes | HMC-EF172 |
| | | 30 Mbytes | HMC-EF372 |
| | | 64 Mbytes | HMC-EF672 |

- Note**
1. A Memory Card can be written up to approximately 100,000 times. (Each write operation to the Memory Card must be counted regardless of the size of the write.) Be particularly careful not to exceed the life of the Memory Card when writing to it from the ladder program.

2. The HMC-AP001 Memory Card Adapter is shown below.

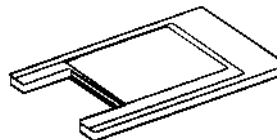

For details on the Memory Card, refer to the *SYSMAC CS-series Programmable Controllers Operation Manual (W339)*.

- Note**
1. Never turn OFF the power supply to the CPU Unit when the BUSY indicator is lit. The Memory Card may become unusable if this is done.
 2. Never remove the Memory Card from the CPU Unit when the BUSY indicator is lit. Press the Memory Card power OFF button and wait for the Card may become unusable if this is not done.

4-10 Clear All

This section provides information on how to clear all the function block data and error log data from the Loop Controller. Take the following steps to clear all the data.

- 1, 2, 3... 1. Select **Operation** and **Clear All** from the Execution Menu. The following dialog box will appear.



2. Click the **OK** Button. A confirmation dialog box will appear.
3. Click the **OK** Button.

Note When CX-Server is being used and a communications timeout error occurs during the Clear All operation, select **Change PLC** from the Settings menu, click the **Network** tab, and set the response timeout time to 10 s or longer.

4-11 Controlling the CPU Unit

If the communications driver is set to the CX-Server and CX-Process Tool version 3.0 or higher is used, the operations described in this section can be performed to control the CPU Unit. These operations enable the CPU Unit to be initialized (i.e., I/O tables created or PLC Setup set) and the operating mode of the CPU Unit to be changed without the CX-Programmer. The following operations are possible.

- Creating the I/O tables
- Setting the PLC Setup
- Changing the operating mode of the CPU Unit

4-11-1 Creating the I/O Tables

- 1, 2, 3... 1. Select **PLC Info – Create I/O Table** from the Settings Menu. The PLC IO Table Dialog Box will be displayed.



2. To create the I/O tables based on information on actually mounted Units, go online, and select **Create** from the Options Menu.

4-11-2 Setting the PLC Setup

- 1, 2, 3... 1. Select **PLC Info – PLC Setting** from the Settings Menu.
2. Set the PLC Setup and then select **Transfer to PLC** from the Options Menus to transfer the PLC Setup to the CPU Unit.

4-11-3 Changing the Operating Mode of the CPU Unit

- 1, 2, 3... 1. Go online and select **PLC Operating Mode** from the Execution Menu. The Change CPU Mode Dialog Box will be displayed.



2. Select the operating mode (PROGRAM, MONITOR, or RUN) in the Mode Field and then click the **Send** Button.

4-12 Password Protection

Password protection can be set in the Loop Controller when using LCB01, LCB03, LCB05, or LCB05D. Setting a password enables uploading operations to be restricted. No restrictions are placed on downloading.

4-12-1 Online Operations for Loop Controller

Setting Passwords in Loop Controller

Use the following procedure to set a password in the Loop Controller connected online.

Note Once a password is set, it must be input under **Program Protection – Input Password** before function block data in the Loop Controller can be uploaded.

- 1, 2, 3...**
1. Select the LCU/LCB element (e.g., 00-LCB05), and then select **Setting – Program Protection – Edit LCB Password**. The following dialog box will be displayed.



2. Enter the password.
3. Click the **OK** Button.

Changing the Loop Controller Password

Use the following procedure to change the password set for the Loop Controller connected online.

- 1, 2, 3...**
1. Select the LCU/LCB element (e.g., 00-LCB05), and then select **Setting – Program Protection – Edit LCB Password**. The following dialog box will be displayed.



2. Enter the current password under *Existing password* and the new password for under *New Password*.
3. Click the **OK** Button.

Note The password protection set here is also in effect for the simple backup operation. Backing up to a Memory Card will thus be disabled, although restoring data will be possible. If the simple backup operation to a Memory Card is performed for a Loop Controller for which a password has been set, an empty backup file will be created in the Memory Card.

Deleting the Loop Controller Password

Use the following procedure to delete the password set for the Loop Controller connected online. The password will also be cleared when the all clear operation or the LCU/LCB is downloaded.

- 1, 2, 3...** 1. Select the LCU/LCB element (e.g., 00-LCB05), and then select **Setting – Program Protection – Edit LCB Password**. The following dialog box will be displayed.



2. Enter the current password under *Existing password* and leave *New Password* empty.
3. Click the **OK** Button. The following dialog box will be displayed.



4. Click the **OK** Button. The password that was previously set in the Loop Controller will be deleted.

4-12-2 Inputting the Password before Uploading Data

The password input using *Setting – Program Protection – Edit LCB Password* must be input before uploading data from a Loop Controller for which password protection has been set. Use the following procedure to input the password.

- 1, 2, 3...** 1. Select the LCU/LCB element (e.g., 00-LCB05), and then select **Setting – Program Protection – Input Password**. The following dialog box will be displayed.



2. Enter the password.
3. Click the **OK** Button.

Note To clear the password that has been input, select the LCU/LCB element (e.g., 00-LCB05), and then select **Setting – Program Protection – Clear Password**.

SECTION 5

Troubleshooting

This section describes errors that can occur while using the CX-Process Tool.

| | | |
|-----|-----------------------|-----|
| 5-1 | Troubleshooting | 318 |
| 5-2 | Error Codes | 319 |

5-1 Troubleshooting

This section provides information on error codes generated during online operation of the CX-Process Tool, along with probable causes of the errors and remedies to be taken.

Error Codes

An error code (FINS response code) appears under each error message as shown below. The cause of the error can be determined from the error code.

Example

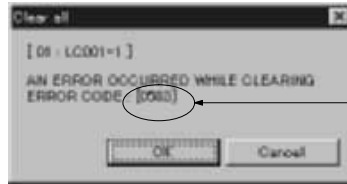

Error code (FINS response code)

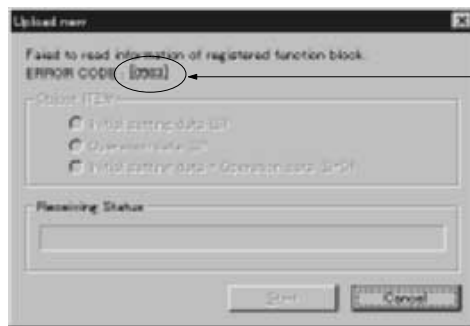

Error code (FINS response code)

5-2 Error Codes

| Error code | | Probable cause | Possible remedy |
|-----------------------|-----------------------|--|--|
| Fins-Gateway | CX-Server | | |
| ERROR CODE: (0001) | ERROR CODE: (0001) | The Loop Controller was accessed during a batch backup. | Try the operation again after the backup has been completed. |
| | | The Loop Controller was accessed during the direct recovery operation. | Wait for the direct recovery operation to finish and then repeat the required operation. |
| ERROR CODE: (0503) | ERROR CODE: (0101) | The FinsGateway has not started up yet. | If the Host Link is used, select Activate Serial Port Driver from the File Menu and initialize the serial port. |
| | --- | | For FinsGateway manual control, select Service Manager from the FinsGateway Menu and start the communications service. |
| --- | --- | The network address settings of the COM1 port and COM2 port of the personal computer in Host Link communications are the same. | Select Fins Network Settings from the FinsGateway Menu. Click the Add Button and make the network settings so that the COM1 and COM2 ports have different network addresses. |
| --- | ERROR CODE: (0A1B) | Peripheral bus or Host Link communications cannot be implemented by the CX-Server. | Select Change PLC from the Setting Menu and check the network type, COM port, and other settings. Correct any settings that are wrong. |
| ERROR CODE: (0502) | ERROR CODE: (0A08) | The network address is wrong. | Select the Project Workspace. Select Network Settings from the Settings Menu and set the correct network address. |
| | | The FinsGateway routing tables incorrect. | Create the correct routing tables. |
| ERROR CODE: (0401) | ERROR CODE: (0A1B) | The node address is wrong. | Select the Project Workspace, select Network Settings from the Settings Menu, and set the correct node address. |
| | ERROR CODE: (0A08) | The unit address is wrong. | Select the LCU/LCB element, select Network Settings from the Settings Menu, and set the correct unit address. |
| | --- | The FinsGateway protocol settings are illegal (e.g., the settings are for SYSMAC WAY communications). | If the Host Link is used, select Activate Serial Port Driver from the File Menu and initialize the serial port. For FinsGateway manual control, select Service Communications Settings from the FinsGateway Menu and set the protocol to SYSMAC WAY CV. |
| ERROR CODE: (0101) | ERROR CODE: (0101) | The designated COM port is being used by another application. | Designate a COM port that is not being used. |
| | | The baud rate setting in the FinsGateway CLK_UNIT are wrong. | Set the correct baud rate. |
| | ERROR CODE: (0A1B) | The PLC is OFF. | Turn ON the PLC. |

| Error code | | Probable cause | Possible remedy |
|-----------------------|-----------------------|---|---|
| Fins-Gateway | CX-Server | | |
| ERROR CODE: (110C) | ERROR CODE: (0A0D) | An attempt has been made to register more than 4,000 step ladder sequence instructions for one Loop Controller. | A maximum of 4,000 step ladder sequence instructions can be registered for each Loop Controller. |
| | | Even though ITEM 059 in the LCB□□'s System Common block (block model 000) is set to 0 to enable using the HMI, the EM Area bank specified in ITEM 050 (EM Area bank to allocate to HMI) cannot be used because the specified bank does not exist in the CPU Unit or the specified bank has been converted to file memory. | Correct the setting of ITEM 050 (EM Area bank to allocate to HMI) in the LCB□□'s System Common block (block model 000). |
| | | An attempt has been made to write an ITEM that cannot be written while the operation of the CX-Process Tool is suspended. | Not all ITEMS can be written while operation is suspended. |
| | | A cold start or hot start was attempted during backup processing. | Execute the cold start after the backup has been completed. |
| ERROR CODE: (0501) | ERROR CODE: (0501) | A destination address is not set in the FinsGateway routing tables. | Correct the routing tables. |
| ERROR CODE: (2006) | ERROR CODE: (2006) | There are no backup files in the Memory Card. | There are no backup files in the Memory Card. Insert a Memory Card containing backup files. |
| ERROR CODE: (2101) | ERROR CODE: (2101) | The backup data in the Memory Card is set to read-only. | Set the backup data in the Memory Card to read/write. The path name of the files is as follows: <memory_card>\LCBDATA\CFBackup.dat |
| ERROR CODE: (2103) | ERROR CODE: (2103) | The number of files in the Memory Card has reached the limit. | Delete files from the Memory Card. |
| ERROR CODE: (2106) | ERROR CODE: (2106) | There are no backup files in the Memory Card. | There are old backup files in the Memory Card in the active CPU Unit when duplex Memory Card operation is being used for Duplex Process-control CPU Units (CS1D-CPU6□P). Delete the old backup files from the Memory Card. |
| ERROR CODE: (2102) | ERROR CODE: (0A16) | (LCB05D only) The backup, clear all, recovery, or download operation was attempted during CPU Unit duplex initialization processing. | A backup, clear all, recover, or download cannot be performed during CPU Unit duplex initialization processing. Perform the backup, clear all, recovery, or download after the CPU Unit duplex initialization processing has been completed. |
| ERROR CODE: (2301) | ERROR CODE: (2301) | There is no Memory Card inserted. | Insert the Memory Card properly. When using duplex Memory Card operation for Duplex Process-control CPU Units (CS1D-CPU6□P), place the same backup files in the Memory Cards for both the active and standby CPU Units. |
| ERROR CODE: (250F) | ERROR CODE: (250F) | The data in the Memory Card is corrupted. | Either the backup data in the Memory Card is corrupted or the Memory Card is damaged. Create the backup files again or use a new Memory Card. |
| ERROR CODE: (3001) | ERROR CODE: (3001) | The Memory Card cannot be accessed. Backup during operation was started when data was being transferred. | Another application is accessing the Memory Card. Wait for the Memory Card to be released and then try again. Transfer the data again after the backup operation has been completed. |
| ERROR CODE: (2108) | ERROR CODE: (2108) | Built-in flash memory is being initialized. | Built-in flash memory is being initialized. Wait for a little while for the initialization of built-in flash memory to be completed and then try transferring the data again. If you still cannot transfer the data, the hardware may be damaged. Contact your OMRON representative. |

| Error code | | Probable cause | Possible remedy |
|-----------------------|-----------------------|--|---|
| Fins-Gateway | CX-Server | | |
| ERROR CODE: (2605) | ERROR CODE: (2605) | A hot start or cold start was attempted immediately after the Loop Controller performed a direct recovery operation. | Cycle the power supply to the Loop Controller or restart the Unit before sending the Operation Command. |
| ERROR CODE: (2606) | ERROR CODE: (2606) | Power was turned OFF when data was being transferred. | Power was turned OFF when data was being transferred. Turn ON the power supply and repeat the transfer operation from the beginning. |

Appendix A

Table of LC Type Changes

Tables 1 and 2, below, show project combinations before and after the changes.

Table 1: Conversion to LCB Project

| | | After change | | | | | | | | | | | | | | |
|---------------|-----------------|--------------|-------|-------|-------|-------|-------|-------|-------|-------|-------|-------|--------|-----------|-------|-------|
| | | LC type | LCB01 | LCB05 | LCB01 | LCB05 | LCB01 | LCB05 | LCB01 | LCB05 | LCB01 | LCB05 | LCB05D | LCB05-GTC | LCB01 | LCB05 |
| Before change | LC type | Unit version | 1.0 | 1.0 | 1.5 | 1.5 | 2.0 | 2.0 | 3.0 | 3.0 | 1.0 | 3.0 | 3.5 | 3.5 | | |
| | LCB01 | 1.0 | --- | ○ | ○ | △ | △ | △ | △ | △ | △ | △ | △ | △ | △ | |
| | LCB05 | 1.0 | × | --- | × | ○ | × | △ | △ | △ | ○ | △ | △ | △ | △ | |
| | LCB01 | 1.5 | ○ | △ | --- | ○ | ○ | △ | △ | △ | △ | △ | △ | △ | △ | |
| | LCB05 | 1.5 | × | ○ | × | --- | × | ○ | △ | △ | △ | △ | △ | △ | △ | |
| | LCB01 | 2.0 | △ | △ | ○ | △ | --- | ○ | ○ | △ | △ | △ | △ | △ | △ | |
| | LCB05 | 2.0 | × | △ | × | ○ | × | --- | △ | ○ | △ | △ | △ | △ | △ | |
| | LCB01 | 3.0 | × | × | × | × | × | × | --- | ○ | × | △ | ○ | △ | △ | |
| | LCB05 | 3.0 | × | × | × | × | × | × | △ | --- | × | ○ | △ | ○ | △ | |
| | LCB05D | 1.0 | × | ○ | × | △ | × | △ | × | △ | --- | △ | △ | △ | △ | |
| | LCB05-GTC | 3.0 | × | × | × | × | × | × | △ | ○ | × | --- | △ | △ | △ | |
| | LCB01 | 3.5 | × | × | × | × | × | × | ○ | △ | × | △ | --- | ○ | △ | |
| | LCB05 | 3.5 | × | × | × | × | × | × | △ | ○ | × | △ | | --- | △ | |
| | CJ1G-CPU42P | 2.0 | △ | △ | △ | △ | ○ | △ | △ | △ | △ | △ | △ | △ | △ | △ |
| | CJ1G-CPU42P | 3.0 | × | × | × | × | × | × | ○ | △ | × | △ | △ | △ | △ | △ |
| | CJ1G-CPU43P | 2.0 | × | △ | × | △ | × | ○ | △ | △ | △ | △ | △ | △ | △ | △ |
| | CJ1G-CPU43P | 3.0 | × | × | × | × | × | × | △ | ○ | × | △ | △ | △ | △ | △ |
| | CJ1G-CPU44P | 2.0 | × | △ | × | △ | × | △ | △ | △ | △ | △ | △ | △ | △ | △ |
| | CJ1G-CPU44P | 3.0 | × | × | × | × | × | × | △ | △ | × | △ | △ | △ | △ | △ |
| | CJ1G-CPU45P | 2.0 | × | △ | × | △ | × | △ | △ | △ | △ | △ | △ | △ | △ | △ |
| | CJ1G-CPU45P | 3.0 | × | × | × | × | × | × | △ | △ | × | △ | △ | △ | △ | △ |
| | CJ1G-CPU45P-GTC | 3.0 | × | × | × | × | × | × | △ | △ | × | ○ | △ | △ | △ | △ |
| | CJ1G-CPU42P | 3.5 | × | × | × | × | × | × | △ | △ | × | △ | ○ | △ | △ | △ |
| | CJ1G-CPU43P | 3.5 | × | × | × | × | × | × | △ | △ | × | △ | △ | △ | ○ | △ |
| | CJ1G-CPU44P | 3.5 | × | × | × | × | × | × | △ | △ | × | △ | △ | △ | △ | △ |
| | CJ1G-CPU45P | 3.5 | × | × | × | × | × | × | △ | △ | × | △ | △ | △ | △ | △ |

○: Can be changed directly. (For example, LCB01 version 1.5 can be changed directly to LCB01 version 2.0.)

△: Can be changed indirectly using a multistep process. (For example, after LCB01 version 1.5 has been changed directly to LCB05 version 1.5, it can then be changed to LCB05 version 2.0.)

×: Cannot be changed either directly or indirectly.

Table 2: Conversion to CJ1G-CPU□□P Loop-control CPU Unit Project



| | | After change | | | | | | | | | | | | | |
|-----------------|-------------|--------------|-------------|-------------|-------------|-------------|-------------|-------------|-------------|-------------|-----------------|-------------|-------------|-------------|-------------|
| | | LC type | CJ1G-CPU42P | CJ1G-CPU43P | CJ1G-CPU44P | CJ1G-CPU45P | CJ1G-CPU42P | CJ1G-CPU43P | CJ1G-CPU44P | CJ1G-CPU45P | CJ1G-CPU45P-GTC | CJ1G-CPU42P | CJ1G-CPU43P | CJ1G-CPU44P | CJ1G-CPU45P |
| Before change | LC type | Unit version | 2.0 | 2.0 | 2.0 | 2.0 | 3.0 | 3.0 | 3.0 | 3.0 | 3.0 | 3.5 | 3.5 | 3.5 | 3.5 |
| | LCB01 | 1.0 | △ | △ | △ | △ | △ | △ | △ | △ | △ | △ | △ | △ | △ |
| | LCB05 | 1.0 | △ | △ | △ | △ | △ | △ | △ | △ | △ | △ | △ | △ | △ |
| | LCB01 | 1.5 | △ | △ | △ | △ | △ | △ | △ | △ | △ | △ | △ | △ | △ |
| | LCB05 | 1.5 | △ | △ | △ | △ | △ | △ | △ | △ | △ | △ | △ | △ | △ |
| | LCB01 | 2.0 | △ | △ | △ | △ | △ | △ | △ | △ | △ | △ | △ | △ | △ |
| | LCB05 | 2.0 | △ | ○ | △ | △ | △ | △ | △ | △ | △ | △ | △ | △ | △ |
| | LCB01 | 3.0 | × | × | × | × | △ | △ | △ | △ | △ | △ | △ | △ | △ |
| | LCB05 | 3.0 | × | × | × | × | △ | ○ | △ | △ | △ | △ | △ | △ | △ |
| | LCB05D | 1.0 | △ | △ | △ | △ | △ | △ | △ | △ | △ | △ | △ | △ | △ |
| | LCB05-GTC | 3.0 | × | × | × | × | △ | △ | △ | △ | ○ | △ | △ | △ | △ |
| | LCB01 | 3.5 | × | × | × | × | △ | △ | △ | △ | △ | △ | △ | △ | △ |
| | LCB05 | 3.5 | × | × | × | × | △ | △ | △ | △ | △ | △ | ○ | △ | △ |
| | CJ1G-CPU42P | 2.0 | --- | ○ | △ | △ | ○ | △ | △ | △ | △ | △ | △ | △ | △ |
| | CJ1G-CPU42P | 3.0 | × | × | × | × | --- | ○ | △ | △ | △ | ○ | △ | △ | △ |
| | CJ1G-CPU43P | 2.0 | ○ | --- | ○ | △ | △ | ○ | △ | △ | △ | △ | △ | △ | △ |
| | CJ1G-CPU43P | 3.0 | × | × | × | × | ○ | --- | ○ | △ | △ | △ | △ | △ | △ |
| | CJ1G-CPU44P | 2.0 | △ | △ | --- | ○ | △ | △ | ○ | △ | △ | △ | △ | △ | △ |
| | CJ1G-CPU44P | 3.0 | × | × | × | × | △ | △ | --- | ○ | △ | △ | △ | ○ | △ |
| | CJ1G-CPU45P | 2.0 | △ | ○ | △ | --- | △ | △ | △ | ○ | △ | △ | △ | △ | △ |
| CJ1G-CPU45P | 3.0 | × | × | × | × | △ | ○ | △ | --- | ○ | △ | △ | △ | ○ | |
| CJ1G-CPU45P-GTC | 3.0 | × | × | × | × | △ | △ | △ | ○ | --- | △ | △ | △ | △ | |
| CJ1G-CPU42P | 3.5 | × | × | × | × | △ | △ | △ | △ | △ | --- | ○ | △ | △ | |
| CJ1G-CPU43P | 3.5 | × | × | × | × | △ | ○ | △ | △ | △ | ○ | --- | ○ | △ | |
| CJ1G-CPU44P | 3.5 | × | × | × | × | △ | △ | △ | △ | △ | △ | △ | --- | ○ | |
| CJ1G-CPU45P | 3.5 | × | × | × | × | △ | △ | △ | △ | △ | △ | △ | △ | --- | |





Appendix B

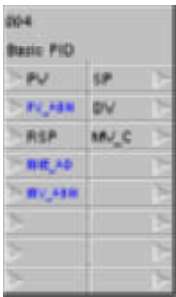

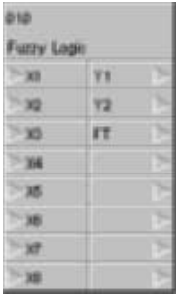

ITEM Notation in Block Diagrams

Table 3, below, lists function block ITEM abbreviations in block diagrams and their corresponding ITEM numbers and data contents. For details on ITEMS, refer to the *Loop Control Board Function Block Reference Manual*.

Table 3: ITEM Abbreviations in Function Block Diagrams

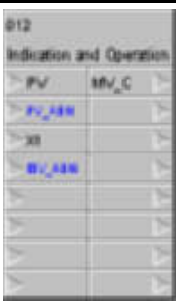
| Function block (Block Model) | Function block diagram | Abbreviation for analog input ITEMS | ITEM number | Data | Abbreviation for analog output ITEMS | ITEM number | Data |
|------------------------------|---|-------------------------------------|-------------|--|--------------------------------------|-------------|---------------------------------------|
| Basic PID (011) |  | PV | 006 | PV source designation | SP | 029 | Current set point output |
| | | PV_ABN | 018 | PV error contact source destination | DV | 044 | Deviation output |
| | | RSP | 021 | Remote set point source designation | MV_C | 087 | MV output |
| | | MIE_AD | 061 | Out-of-range processing at MV output destination block | --- | --- | --- |
| | | MV_ABN | 090 | MV error contact source destination | --- | --- | --- |
| Advanced PID (012) |  | PV | 006 | PV source designation | SP | 029 | Deviation output |
| | | PV_ABN | 018 | PV error contact source destination | DV | 044 | Deviation output |
| | | RSP | 021 | Remote set point source designation | MVCMP | 071 | Output for MV compensation |
| | | PVCMP_A | 047 | PV compensation source designation | MV_C | 087 | MV output |
| | | MIE | 061 | Out-of-range processing at MV output destination block | --- | --- | --- |
| | | MVCMP_A | 074 | MV compensation source designation | --- | --- | --- |
| | | MVTRK | 083 | MV tracking source designation | --- | --- | --- |
| | | MV_ABN | 090 | MV error contact source destination | --- | --- | --- |
| Blended PID (013) |  | P1 | 006 | PV source designation | Q1 | 012 | Accumulated value (lower 4 digits) |
| | | P2 | 021 | P2 source designation | Q2 | 013 | Accumulated value (upper 4 digits) |
| | | MV_ABN | 090 | MV error contact source designation | Y1 | 016 | PV instantaneous value output |
| | | --- | --- | --- | Y2 | 029 | Current SP instantaneous value output |
| | | --- | --- | --- | DEV_Q | 044 | Cumulative deviation output |
| | | --- | --- | --- | MV_C | 087 | MV output |

| Function block (Block Model) | Function block diagram | Abbreviation for analog input ITEMS | ITEM number | Data | Abbreviation for analog output ITEMS | ITEM number | Data |
|------------------------------|---|-------------------------------------|-------------|-------------------------------------|--------------------------------------|-------------|--|
| Batch Flowrate Capture (014) |  | P1 | 006 | P1 source designation | Q1 | 012 | Accumulated value (lower 4 digits) |
| | | RSP | 021 | Remote SP source designation | Q2 | 013 | Accumulated value (upper 4 digits) |
| | | RSPU | 027 | Remote SP source designation | Y1 | 016 | Instantaneous value output |
| | | MV_ABN | 090 | MV error contact source designation | SP | 029 | Current SP output (lower 4 digits) |
| | | --- | --- | --- | SPU_W | 030 | Current SP output (upper 4 digits) |
| | | --- | --- | --- | SM | 035 | Batch accumulated value (lower 4 digits) |
| | | --- | --- | --- | SMU | 065 | Batch accumulated value (upper 4 digits) |
| | | --- | --- | --- | MV_C | 087 | Program output |
| 2-position ON/OFF (001) |  | PV | 006 | PV source designation | SP | 029 | Current set point output |
| | | PV_ABN | 018 | PV error contact source designation | DV | 044 | Deviation output |
| | | RSP | 021 | Remote set point source designation | --- | --- | --- |
| 3-position ON/OFF (002) |  | PV | 006 | PV source designation | SP | 029 | Current set point output |
| | | PV_ABN | 018 | PV error contact source designation | DV | 044 | Deviation output |
| | | RSP | 021 | Remote set point source designation | --- | --- | --- |
| Fuzzy Logic (016) |  | X1 | 015 | X1 input value | Y1 | 031 | Y1 output value |
| | | to | | to | Y2 | 032 | Y2 output value |
| | | X8 | 022 | X8 input value | FT | 036 | Applicability for each rule |
| Indication and Setting (031) |  | PV | 006 | PV source designation | SP | 029 | Current SP setting |
| | | PV_ABN | 018 | PV error contact source designation | --- | --- | --- |
| | | RSP | 021 | Remote set point source designation | --- | --- | --- |

| Function block (Block Model) | Function block diagram | Abbreviation for analog input ITEMS | ITEM number | Data | Abbreviation for analog output ITEMS | ITEM number | Data |
|----------------------------------|---|-------------------------------------|-------------|---|--------------------------------------|-------------|----------------------|
| Indication and Operation (032) |  | PV | 006 | PV source designation | MV_C | 087 | MV output |
| | | PV_ABN | 018 | PV error contact source designation | --- | --- | --- |
| | | X1 | 083 | Auto input source designation | --- | --- | --- |
| | | MV_ABN | 090 | MV error contact source designation | --- | --- | --- |
| Ratio Setting (033) |  | PV | 006 | Reference input source designation | SP | 029 | Current SP output |
| | | PV_ABN | 018 | PV error contact source designation | MV_C | 087 | MV Output |
| | | RSP | 021 | External ratio setting source designation | --- | --- | --- |
| | | MV_ABN | 090 | MV error contact source designation | --- | --- | --- |
| Indicator (034) |  | PV | 006 | PV source designation | --- | --- | --- |
| | | PV_ABN | 018 | PV error contact source designation | --- | --- | --- |
| ES100X Controller Terminal (045) |  | RSP | 021 | External ratio setting source designation | PV | 021 | PV measured value |
| | | --- | --- | --- | SP_DSP | 022 | Set point |
| | | --- | --- | --- | MV_C | 023 | Manipulated variable |
| | | --- | --- | --- | SP | 029 | Current SP setting |

Appendix C

Setting Segment Programs

A special input interface is provided for setting program patterns and bank data for Segment Program 2 (Block Model 157) and Segment Program 3 (Block Model 158) blocks.

This section describes how to set individual parameters from the CX-Process Tool. For details on block function specifications and functions, and information on specific operations, refer to the *Loop Control Board Function Block Reference Manual*.

Setting Segment Program 2 Blocks

Use the following method to set the program pattern.

1. Open the Segment Program 2 ITEM list, right-click in the ITEM list, and select **Extension** from the pop-up menu.

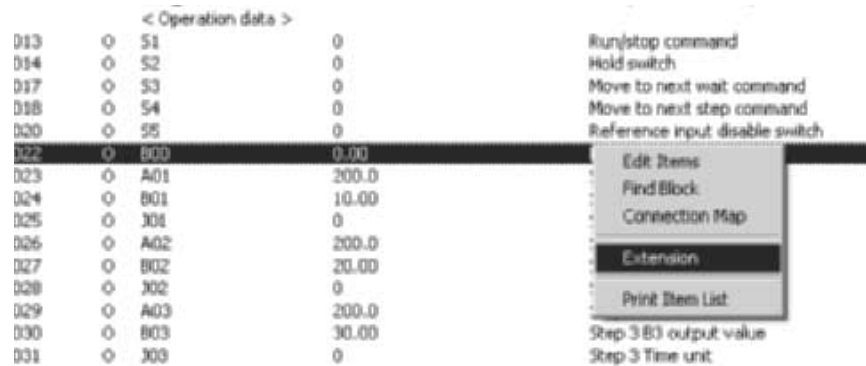

2. The Edit Segment Program 2 Parameters Window will be displayed.

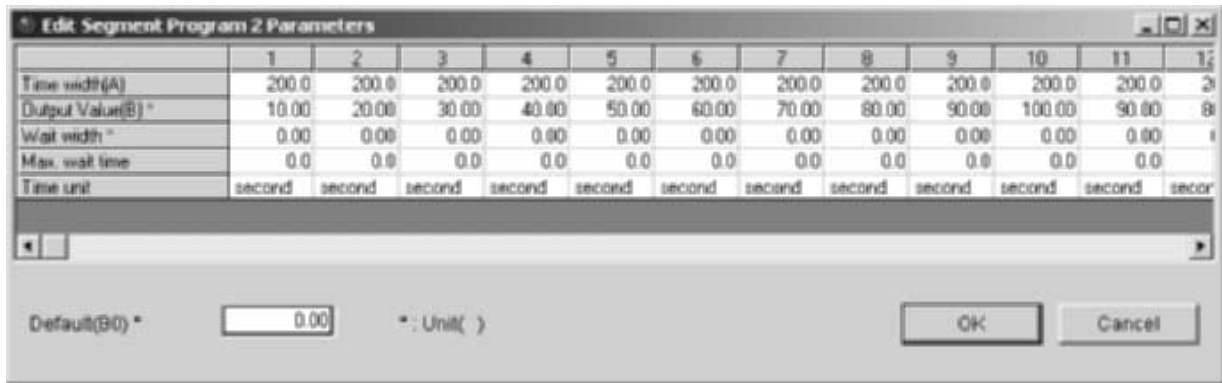

The contents of the ITEMS for each step will be displayed in table format. When the table is directly edited and the **OK** Button is pressed, the values will be reflected in the function block ITEMS. (For details on the editing function, refer to *Edit Window Functions*.)

The items in the Edit Window are as follows:

Horizontal Axis

- 1 to 30: Step numbers

Vertical Axis

Time width (A): Used to set the time width as A.

Output value (B): Used to set the output value as B. The value will be displayed in engineering units if the Engineering Unit Mode is set.

Wait width: Used to set the wait width. The value will be displayed in engineering units if the Engineering Unit Mode is set.

Max. wait time: Used to set the maximum wait time.

Time unit: Used to set the time unit (to seconds, minutes, or hours).

Initial output value: Used to set the B0 value. The value will be displayed in engineering units if the Engineering Unit Mode is set.

Unit: The unit will be displayed if the Engineering Unit Mode is set.

Setting Segment Program 3

Use the following procedure to make the settings for Segment Program 3.

1. Open the Segment Program 3 ITEM list, right-click in the ITEM list, and select **Extension** from the pop-up menu.

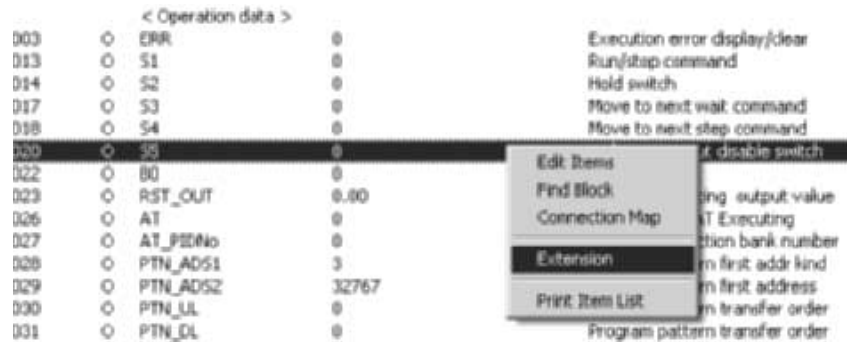

2. The Edit Segment Program 3 Parameters Window will be displayed.

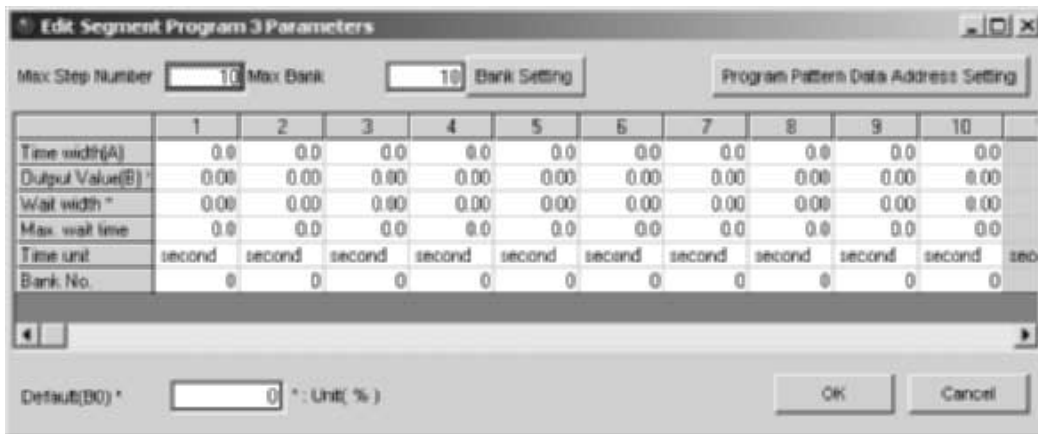

The contents of the ITEMS for each step will be displayed in table format. When the table is directly edited and the **OK** Button is pressed, the values will be reflected in the function block ITEMS. (For details on the editing function, refer to *Edit Window Functions*.)

The items in the Edit Window are as follows:

Horizontal Axis

1 to 100: Step numbers

Vertical Axis

Time width (A): Used to set the time width as A.

Output value (B): Used to set the output value as B. The value will be displayed in engineering units if the Engineering Unit Mode is set.

Wait width: Used to set the wait width. The value will be displayed in engineering units if the Engineering Unit Mode is set.

Max. wait time: Used to set the maximum wait time.

Time unit: Used to set the time unit (to seconds, minutes, or hours).

Bank No.: Displays the bank number to be used.

Maximum number of steps used (Max Step Number): Used to set the maximum number of steps to be used. The default setting is 10.

Maximum number of banks used (Max Bank): Used to set the maximum number of banks to be used. The default setting is 0.

Bank Setting Button: Used to edit bank data.

Program Pattern Data Address Setting Button: Used to set the beginning address in the program pattern data.

Initial output value: Used to set the B0 value. The value will be displayed in engineering units if the Engineering Unit Mode is set.

Unit: The unit will be displayed if the Engineering Unit Mode is set.

Setting Step Data

Step data is edited using the Segment Program 3 Edit Window. For details on editing, refer to *Edit Window Functions*.

Setting the Maximum Number of Steps to Be Used

The maximum number of steps to be used refers to the number of steps to be used in a single program. Segment Program 3 stores in step data blocks the data to be used in the program. The number of step data blocks required depends on the number of steps to be used.

- Up to 25 steps of data can be stored per step data block. When a maximum of 100 steps is used, the number of step data blocks used is 4.
For example, when 70 steps are used, the maximum number of steps is taken to be 70, and 3 step data blocks are automatically registered.
- The steps that can be used can be edited on the Edit Window. Any steps beyond the maximum number of steps cannot be edited.

Changing the Maximum Number of Steps to Be Used

The maximum number of steps to be used can normally be changed. The following dialog box will be displayed if the maximum number of steps to be used is changed and there is a change in the registration status of the step data blocks.



If this dialog box is displayed, use any of the following methods to resend a Segment Program 3 block to the Loop Controller.

- Transfer the entire project.
Select an LCU/LCB element (LCB) from the project tree. Then right-click and select **Transfer to LC** from the pop-up menu, or select **Execution - Transfer to LC - Selected** from the Main Menu.
- Transfer the Segment Program 3 block only.
Select the applicable Segment Program 3 block from the project tree. Then right-click and select **Transfer to LC** from the pop-up menu, or select **Execution - Transfer to LC - Selected** from the Main Menu.

Automatic Registration of Step Data Blocks

Step data blocks are automatically registered according to the following rules, depending on the number of steps to be used.

- Step data blocks are registered in the function block group in which Segment Program 3 (Block Model 158) is registered.
- Step data blocks are registered in descending order from the highest available function block address.
LCB01, CJ1G-CPU42P: 50, 49, 48...

CS1W-LCB05: 500, 499, 498...

CJ1G-CPU43, 44, 45P: 300, 299, 298...

- When the maximum number of steps to be used is increased, rule #2 is followed. When the number is decreased, step data blocks are removed in ascending order from the lowest function block address.

Setting Bank Data

To edit bank data, press the **Bank Setting** Button in the Segment Program 3 Edit Screen. The following Edit Bank Parameters Window will be displayed. For details on editing, refer to *Edit Window Functions*.

| | P | I | D | MH | ML | Extra Data1 | Extra Data2 | Extra Data3 | Extra Data4 | Extra Data5 |
|----|-------|---|---|--------|------|-------------|-------------|-------------|-------------|-------------|
| 1 | 100.0 | 0 | 0 | 105.00 | 0.00 | 0.00 | 0.00 | 0.00 | 0.00 | 0.00 |
| 2 | 100.0 | 0 | 0 | 105.00 | 0.00 | 0.00 | 0.00 | 0.00 | 0.00 | 0.00 |
| 3 | 100.0 | 0 | 0 | 105.00 | 0.00 | 0.00 | 0.00 | 0.00 | 0.00 | 0.00 |
| 4 | 100.0 | 0 | 0 | 105.00 | 0.00 | 0.00 | 0.00 | 0.00 | 0.00 | 0.00 |
| 5 | 100.0 | 0 | 0 | 105.00 | 0.00 | 0.00 | 0.00 | 0.00 | 0.00 | 0.00 |
| 6 | 100.0 | 0 | 0 | 105.00 | 0.00 | 0.00 | 0.00 | 0.00 | 0.00 | 0.00 |
| 7 | 100.0 | 0 | 0 | 105.00 | 0.00 | 0.00 | 0.00 | 0.00 | 0.00 | 0.00 |
| 8 | 100.0 | 0 | 0 | 105.00 | 0.00 | 0.00 | 0.00 | 0.00 | 0.00 | 0.00 |
| 9 | 100.0 | 0 | 0 | 105.00 | 0.00 | 0.00 | 0.00 | 0.00 | 0.00 | 0.00 |
| 10 | 100.0 | 0 | 0 | 105.00 | 0.00 | 0.00 | 0.00 | 0.00 | 0.00 | 0.00 |
| 11 | 100.0 | 0 | 0 | 105.00 | 0.00 | 0.00 | 0.00 | 0.00 | 0.00 | 0.00 |
| 12 | 100.0 | 0 | 0 | 105.00 | 0.00 | 0.00 | 0.00 | 0.00 | 0.00 | 0.00 |
| 13 | 100.0 | 0 | 0 | 105.00 | 0.00 | 0.00 | 0.00 | 0.00 | 0.00 | 0.00 |
| 14 | 100.0 | 0 | 0 | 105.00 | 0.00 | 0.00 | 0.00 | 0.00 | 0.00 | 0.00 |
| 15 | 100.0 | 0 | 0 | 105.00 | 0.00 | 0.00 | 0.00 | 0.00 | 0.00 | 0.00 |
| 16 | 100.0 | 0 | 0 | 105.00 | 0.00 | 0.00 | 0.00 | 0.00 | 0.00 | 0.00 |
| 17 | 100.0 | 0 | 0 | 105.00 | 0.00 | 0.00 | 0.00 | 0.00 | 0.00 | 0.00 |
| 18 | 100.0 | 0 | 0 | 105.00 | 0.00 | 0.00 | 0.00 | 0.00 | 0.00 | 0.00 |
| 19 | 100.0 | 0 | 0 | 105.00 | 0.00 | 0.00 | 0.00 | 0.00 | 0.00 | 0.00 |
| 20 | 100.0 | 0 | 0 | 105.00 | 0.00 | 0.00 | 0.00 | 0.00 | 0.00 | 0.00 |
| 21 | 100.0 | 0 | 0 | 105.00 | 0.00 | 0.00 | 0.00 | 0.00 | 0.00 | 0.00 |
| 22 | 100.0 | 0 | 0 | 105.00 | 0.00 | 0.00 | 0.00 | 0.00 | 0.00 | 0.00 |
| 23 | 100.0 | 0 | 0 | 105.00 | 0.00 | 0.00 | 0.00 | 0.00 | 0.00 | 0.00 |
| 24 | 100.0 | 0 | 0 | 105.00 | 0.00 | 0.00 | 0.00 | 0.00 | 0.00 | 0.00 |
| 25 | 100.0 | 0 | 0 | 105.00 | 0.00 | 0.00 | 0.00 | 0.00 | 0.00 | 0.00 |

The items in the Edit Window are as follows:

Horizontal Axis

P, I, and D: Used to set PID parameters.

MH and ML: Used to set the MH and ML values for a connected PID block.

Extra Data 1 to 5: Used to set extra data 1 to 5.

Vertical Axis

Bank number (1 to 100): Indicates the bank number.

Setting the Maximum Number of Banks to Be Used

The maximum number of banks to be used refers to the number of banks to be used in a single program. A Segment Program 3 block stores in bank data blocks the bank data to be used in the program. The number of bank data blocks required depends on the number of banks to be used.

- Up to 15 banks of data can be stored per bank data block. When a maximum of 100 steps is used, 7 bank data blocks are used.
For example, when 70 banks are used, the maximum number of banks is taken to be 70, and 5 bank data blocks are automatically registered.
- The banks that can be used can be edited on the Edit Window. Any banks beyond the maximum number of banks cannot be edited.

Changing the Maximum Number of Banks to Be Used

The maximum number of banks to be used can normally be changed. The following dialog box will be displayed if the maximum number of banks to be used is changed and there is a change in the registration status of the bank data blocks.

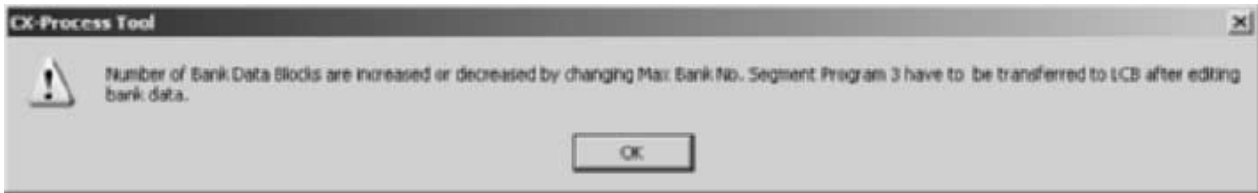

If this dialog box is displayed, use any of the following methods to resend Segment Program 3 to the Loop Controller.

- Transfer the entire project.
Select an LCU/LCB element (LCB) from the project tree. Then right-click and select **Transfer to LC** from the pop-up menu, or select **Execution - Transfer to LC - Selected** from the Main Menu.
- Transfer the Segment Program 3 block only.
Select the applicable Segment Program 3 block from the project tree. Then right-click and select **Transfer to LC** from the pop-up menu, or select **Execution - Transfer to LC - Selected** from the Main Menu.

Automatic Registration of Bank Data Blocks

Bank data blocks are automatically registered according to the following rules, depending on the number of banks to be used.

- Bank data blocks are registered in the function block group in which Segment Program 3 (Block Model 158) block is registered.
- Bank data blocks are registered in descending order from the highest available function block address.
LCB01, CJ1G-CPU42P: 50, 49, 48...
CS1W-LCB05: 500, 499, 498...
CJ1G-CPU43, 44, 45P: 300, 299, 298...
- When the maximum number of banks to be used is increased, rule #2 is followed. When the number is decreased, bank data blocks are removed in ascending order from the lowest function block address.

Setting Program Pattern Data

To set program pattern addresses, press the **Program Pattern Data Address Setting** Button in the Edit Segment Program 3 Parameters Window. The following Edit Program Pattern Block Parameters Window will be displayed.



The items in the Settings Window are as follows:

Area type: CIO, W, H, DM, or E0 to E12 (EC) can be selected.

Beginning address: Used to set the beginning address for allocating program pattern data.

PLC memory allocation images:

Left column: Indicates the beginning and end of the addresses allocated for program pattern data.

Center and right columns: Descriptions of the parameters stored in each address are displayed.

Check Memory Area Button: Used to display Loop Controller memory maps. When program pattern data is allocated, memory can be checked to ensure that no addresses are duplicated. For details, refer to *3-10 Displaying Loop Controller Memory Maps*.

Executing Auto-tuning in a Tuning Window

Use the following procedure to specify a PID bank and execute the Auto-tuning (AT) command.

1. With the Segment Program 3 Tuning Window displayed, click the **AT** Button.

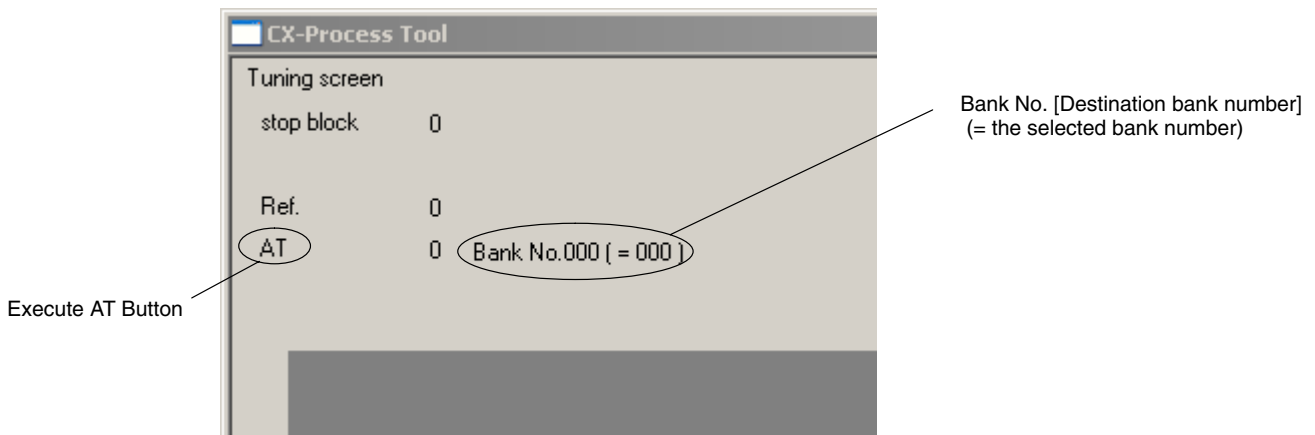

AT Button: The button for executing AT

Destination bank No.: The bank number where the AT execution results are to be stored

Selected bank number: The bank number specified in the step being executed

2. The Execute AT Dialog Box will be displayed.

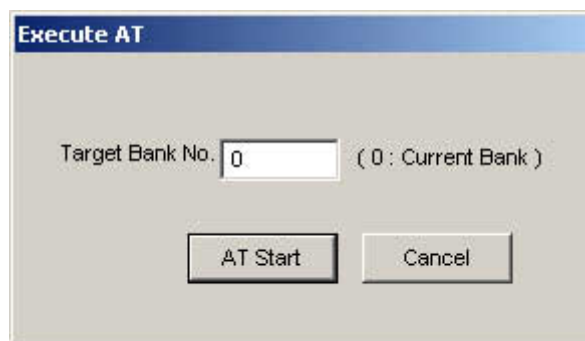

3. In the *Target Bank No.* field, input the bank number where the AT execution results are to be stored. If 0 is input, the AT execution results will be stored at the current bank (i.e., the bank number specified in the step currently being executed).

4. Click the **AT Start** Button. The **AT Start** Button will be changed into the **Stop AT** Button. To cancel the auto-tuning in progress, click the **Stop AT** Button.

Edit Window Functions

The following functions can be executed in the Edit Windows used for Segment Program settings.

Edit

Editing is possible by either selecting cells on the Edit Window and inputting parameters directly, or right-clicking and selecting **Edit** from the pop-up menu.

- Press the **Enter** Key to move to a lower cell. When the cursor is in the bottom cell, it will next move to the to the cell in the top row.
- Pressing the **Esc** Key during an input will cancel the input and restore the original value.

Undo

Used to undo an operation and restore edited data. A buffer is provided for up to 10 undo operations.

Note “Transfer to LC” operations cannot be undone.

Redo

Used to redo an action that was undone using the undo function.

Note “Transfer to LC” operations cannot be redone.

Copy and Paste

By right-clicking and selecting **Copy** from the pop-up menu, cell contents can be copied to the clipboard. The copied data can then be pasted by clicking on a cell, right-clicking to display the pop-up menu, and selecting **Paste**.

- It is possible to select and copy multiple cells.
- Text data edited using an external editor can be pasted.

Fill

Used to copy data from a selected cell to all steps and set the same data for an entire line. Select a cell and then right-click and select **Fill** from the pop-up menu.

Insert Columns

Used to insert step columns. Select all the data in the column to be inserted, and then right-click and select **Insert Columns** from the pop-up menu.

- When multiple columns are selected, the selected number of columns can be inserted.
- Parameter default values are automatically input into inserted columns.

When new columns are inserted, an equivalent number of columns of step data is deleted from the last step columns. The last step in a Segment Program 2 block is step 30, and the last step in a Segment Program 3 block is step 100.

Delete Column

Used to delete step columns. Select all of the data in the column to be deleted, and then right-click and select **Delete Column** from the pop-up menu. To select all of the column data, click the step number in the table.

- It is possible to select and delete multiple columns.
- When columns are deleted, an equivalent number of columns of step data is inserted from the last step column. The last step in a Segment Program 2 block is step 30, and the last step in a Segment Program 3 block is step 100. The default values are set for all data in the newly inserted columns.

Move Column

Used to move step columns. Select all of the data in the column to be moved, and then right-click and select **Move Column** from the pop-up menu. To select all of the column data, click the step number in the table.

When Move Column is selected, the cursor is changed to . The column will move when selected in this state.

- Multiple columns can be selected and moved.

Transfer to LC

Used to transfer the data in selected cells to the Loop Controller.

- Multiple cells or columns can be selected and transferred.

Note Be sure to check the safety of all equipment before making a transfer while the Loop Controller is operating.

Appendix D

Sequence Table Design Sheet

A sequence table design sheet is provided below. It can be copied for use when making sequence table program settings.

Revision History

A manual revision code appears as a suffix to the catalog number on the front cover of the manual.

Cat. No. W372-E1-11

Revision code

The following table outlines the changes made to the manual during each revision. Page numbers refer to the previous version.

| Revision code | Date | Revised content |
|---------------|----------------|---|
| 01 | May 2000 | Original production |
| 02 | December 2000 | CX-Process Tool version changed from 1.50 to 2.00. The manual has been updated for this version change as summarized in section 1-2-3. |
| 03 | September 2001 | <p>CX-Process Tool version changed from 2.00 to 2.50. The manual has been updated for this version change as summarized in section 1-2-4 and the following information has been added (major changes only).</p> <p>Page 18: Lists of function blocks and ITEMS incompatible with earlier versions</p> <p>Page 20: Explanation of new dialog box used to select communications driver</p> <p>Page 23: Explanation of CX-Server connections</p> <p>Page 44: Explanation of CX-Server installation</p> <p>Page 66: Explanation of PLC type, CPU type, and network type selection</p> <p>Page 76: Explanation of annotations (comments) in function blocks</p> <p>Page 96: Explanation of the automatic conversion between mnemonic code and ladder diagram formats</p> <p>Page 100: Explanation of annotations (comments) in ladder diagrams</p> <p>Page 131: Explanation of initial settings required when using CX-Server</p> <p>Page 133: Explanation of initial settings required when using a Peripheral Bus connection</p> <p>Page 154: Explanation of downloading individual ITEM settings</p> <p>Page 162: Explanation of the online tuning function</p> |
| 04 | October 2002 | CX-Process Tool version changed from 2.50 to 3.00. The manual has been updated for this version change as summarized in section 1-4-5. |
| 05 | April 2003 | CX-Process Tool version changed from 3.0 to 3.1. The manual has been updated for this version change as summarized in section 1-4-6. |
| 06 | December 2003 | CX-Process Tool version changed from 3.1 to 3.2. The manual has been updated for this version change as summarized in section 1-4-7. |
| 07 | August 2004 | CX-Process Tool version changed from 3.2 to 4.0. The manual has been updated for this version change as summarized in section 1-4-8. The safety precautions have also been changed and new precautions added. Terminology used to refer to the Loop Control Units and Boards has been changed, with an explanation provided at the beginning of the manual. |
| 08 | February 2005 | CX-Process Tool version changed from 4.0 to 4.1. The manual has been updated for this version change as summarized in section 1-4-9. Minor corrections have also been made. |
| 09 | November 2005 | CX-Process Tool version changed from 4.1 to 5.0. The manual has been updated for this version change as summarized in section 1-4-10. Minor corrections have also been made. |

Revision History

| Revision code | Date | Revised content |
|----------------------|---------------|--|
| 10 | July 2006 | CX-Process Tool version changed from 5.0 to 5.1. The manual has been updated for this version change as summarized in section 1-4-11. Minor corrections have also been made. |
| 11 | November 2007 | The CX-Process Tool version has been changed from 5.1 to 5.2. The CX-One version has been changed to 2.1. Loop Controller functions have been improved. The manual has been updated for these changes as summarized in <i>1-4 Version Improvements</i> . |